



Cambridge International Examinations
Cambridge International General Certificate of Secondary Education

* 0 1 2 3 4 5 6 7 8 9 *

PHYSICS

0625/02

Paper 2 Multiple Choice (Extended)

For Examination from 2016

SPECIMEN PAPER

45 minutes

Additional Materials: Multiple Choice Answer Sheet
 Soft clean eraser
 Soft pencil (type B or HB is recommended)

READ THESE INSTRUCTIONS FIRST

Write in soft pencil.

Do not use staples, paper clips, glue or correction fluid.

Write your name, Centre number and candidate number on the Answer Sheet in the spaces provided unless this has been done for you.

DO NOT WRITE IN ANY BARCODES.

There are **forty** questions on this paper. Answer **all** questions. For each question there are four possible answers **A, B, C** and **D**.

Choose the **one** you consider correct and record your choice in **soft pencil** on the separate Answer Sheet.

Read the instructions on the Answer Sheet very carefully.

Each correct answer will score one mark. A mark will not be deducted for a wrong answer.

Any rough working should be done in this booklet.

Electronic calculators may be used.

Take the weight of 1.0 kg to be 10 N (acceleration of free fall = 10 m/s^2)

The syllabus is accredited for use in England, Wales and Northern Ireland as a Cambridge International Level 1/Level 2 Certificate.

This document consists of **23** printed pages and **1** blank page.

- 1 Which quantity is measured in newton seconds (Ns)?
- A** impulse
- B** moment
- C** power
- D** work done
- 2 Which measurement can be made using a micrometer screw gauge?
- A** the air pressure of a tyre
- B** the diameter of a wire
- C** the turning effect of a spanner
- D** the wavelength of microwaves

- 3 A parachutist is falling at terminal velocity, without her parachute open.

She now opens her parachute.

What is the direction of her motion, and what is the direction of her acceleration, immediately after she opens her parachute?

	direction of motion of the parachutist	direction of acceleration of the parachutist
A	downwards	downwards
B	downwards	upwards
C	upwards	downwards
D	upwards	upwards

- 4 An astronaut in an orbiting spacecraft experiences a force due to gravity. This force is less than when she is on the Earth's surface.

Compared with being on the Earth's surface, how do her mass and her weight change when she goes into orbit?

	mass in orbit	weight in orbit
A	decreases	decreases
B	decreases	unchanged
C	unchanged	decreases
D	unchanged	unchanged

- 5 The diagram shows an experiment to find the density of a liquid.

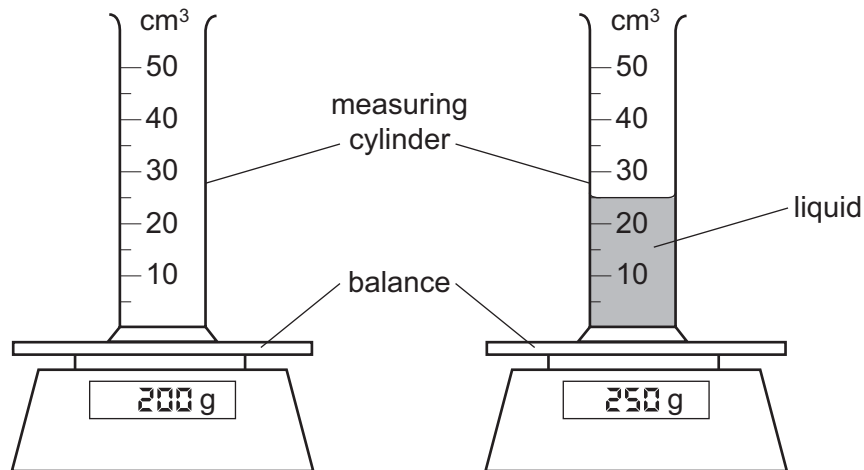

What is the density of the liquid?

- A 0.5g/cm³ B 2.0g/cm³ C 8.0g/cm³ D 10.0g/cm³
- 6 An experiment is carried out to measure the extension of a rubber band for different loads.

The results are shown below.

load / N	0	1.0	2.0	3.0
length / cm	15.2	16.2		18.6
extension / cm	0	1.0	2.1	3.4

Which figure is missing from the table?

- A 17.2 B 17.3 C 17.4 D 17.6
- 7 The diagram shows a satellite that is moving at a uniform rate in a circular orbit around the Earth.

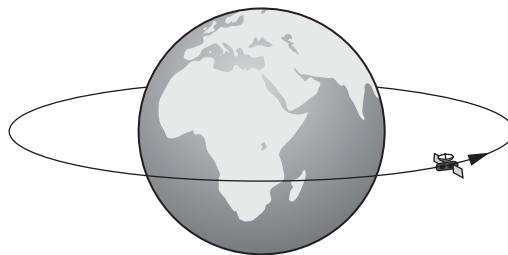

Which statement describes the motion of this satellite?

- A It is accelerating because its speed is changing.
 B It is accelerating because its velocity is changing.
 C It is not accelerating but its speed is changing.
 D It is not accelerating but its velocity is changing.

- 8 Which statement about an object moving in a straight line through air is correct?
- A When it accelerates, the resultant force acting on it is zero.
 - B When it moves at a steady speed, the air resistance acting on it is zero.
 - C When it moves at a steady speed, the resultant force acting on it is zero.
 - D When it moves, there is a resultant force acting on it.
- 9 A beam pivoted at one end has a force of 5.0 N acting vertically upwards on it as shown. The beam is in equilibrium.

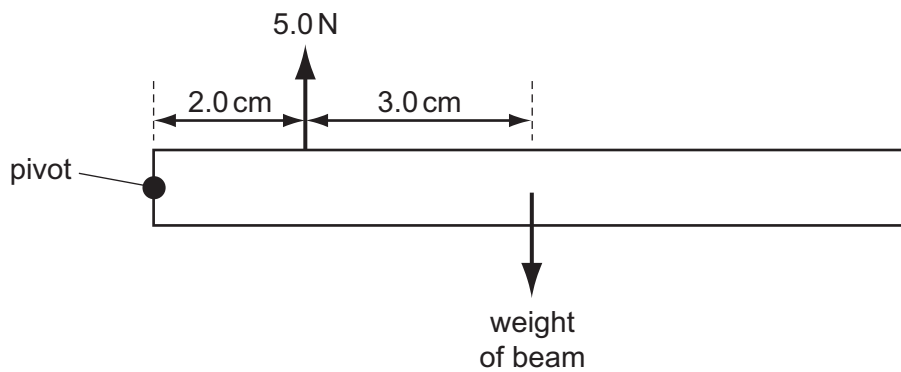

What is the weight of the beam?

- A 2.0 N
 - B 3.0 N
 - C 3.3 N
 - D 5.0 N
- 10 A car has a mass of 1000 kg and a momentum of 12 000 kg m/s.
- What is its kinetic energy?
- A 6 kJ
 - B 12 kJ
 - C 72 kJ
 - D 144 kJ

11 Which diagram shows two forces X and Y with their resultant force?

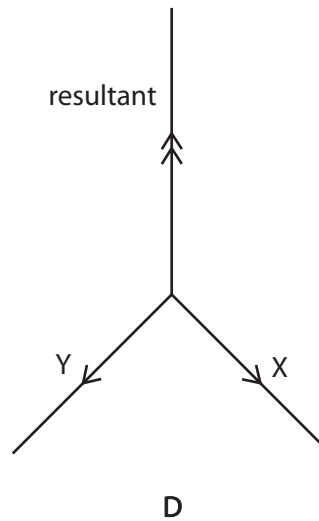
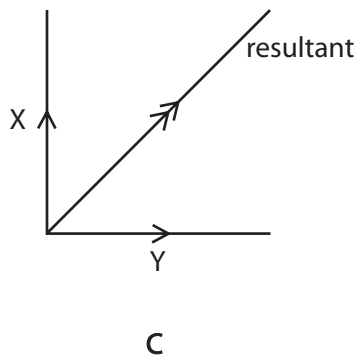
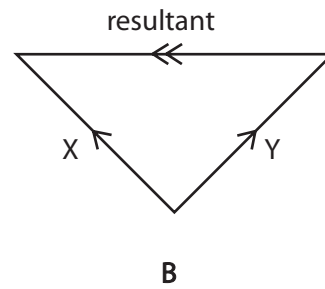
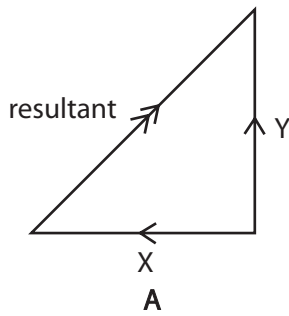

12 A ball is dropped on to a hard surface and bounces. It does not bounce all the way back to where it started, and so has not regained all of its original gravitational potential energy.

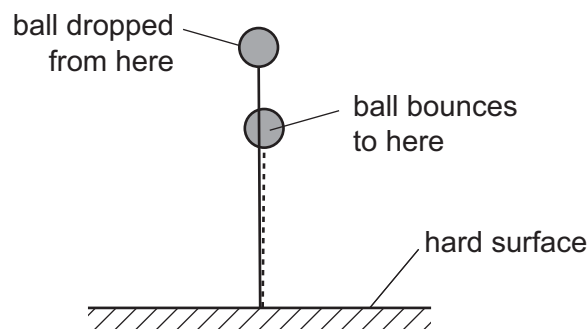

Which statement accounts for the loss of gravitational potential energy?

- A Energy was destroyed as the ball hit the ground.
- B Energy was destroyed as the ball travelled through the air.
- C The chemical energy and elastic energy of the ball have increased.
- D The internal (heat) energy of the ball and its surroundings has increased.

13 The Sun is the original source of energy for many of our energy resources.

Which energy resource **does not** originate from the Sun?

- A geothermal
- B hydroelectric
- C waves
- D wind

14 A dam across a lake is divided into two sections by a rock. Section X is longer than section Y but the two sections are otherwise identical. The water in the lake by the dam is the same depth everywhere. The diagram shows a view from above of the lake and the dam.

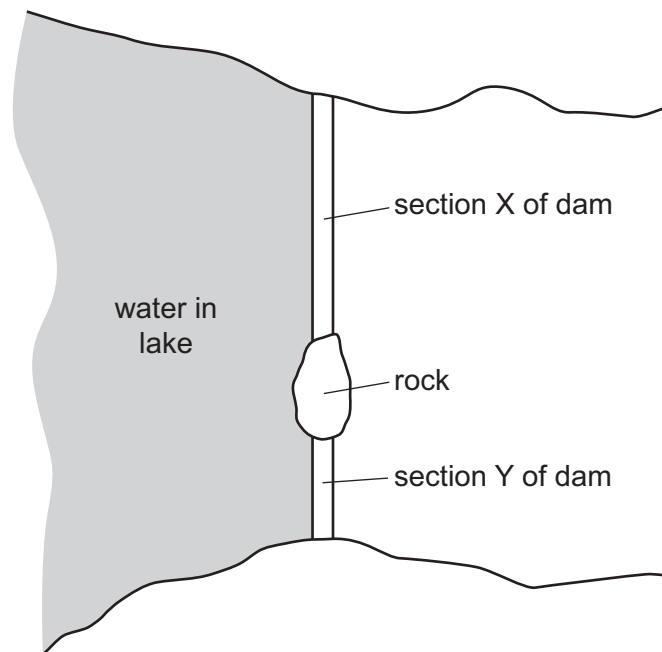

The water creates a total force on each section of the dam and an average pressure on each section of the dam.

Which statement is correct?

- A The average pressure on X equals the average pressure on Y.
- B The average pressure on X is less than the average pressure on Y.
- C The total force on X equals the total force on Y.
- D The total force on X is less than the total force on Y.

- 15 The diagram shows a simple mercury barometer alongside a mercury manometer. The manometer contains some trapped gas.

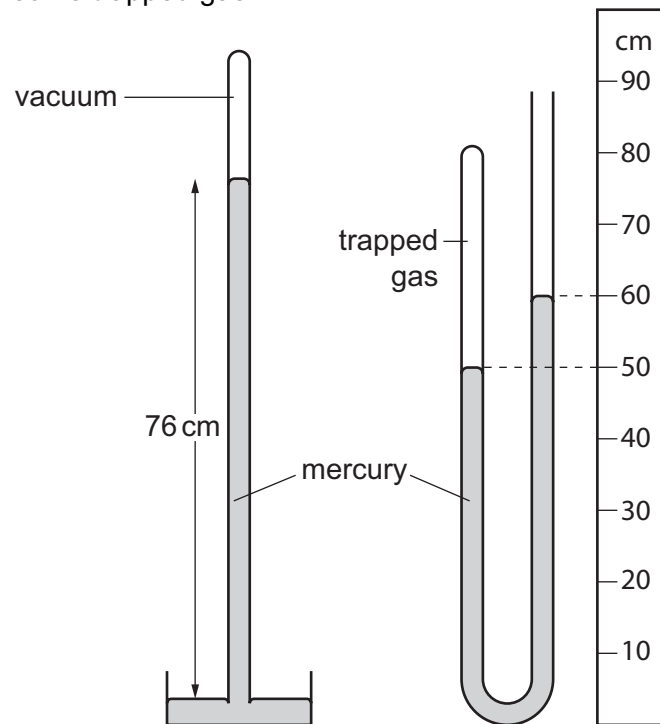

What is the pressure of the trapped gas?

- A 10 cm of mercury
- B 50 cm of mercury
- C 66 cm of mercury
- D 86 cm of mercury

- 16** Very small pollen grains are suspended in a beaker of water. A bright light shines from the side.

Small, bright dots of light are seen through a microscope. The dots move in rapidly changing, random directions.

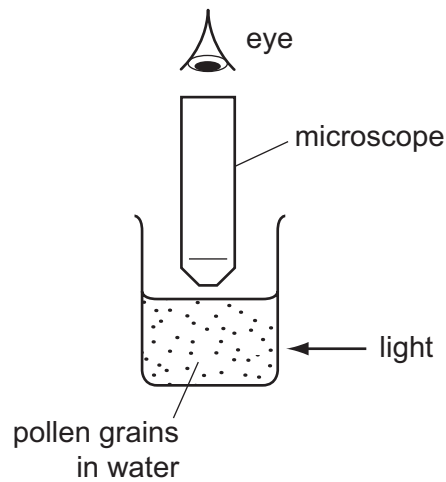

What are the bright dots?

- A** pollen grains being hit by other pollen grains
 - B** pollen grains being hit by water molecules
 - C** water molecules being hit by other water molecules
 - D** water molecules being hit by pollen grains
- 17** A sealed gas cylinder is left outside on a hot, sunny day.

What happens to the average speed of the gas molecules and to the pressure of the gas in the cylinder as the temperature of the gas rises?

	average speed of gas molecules	pressure of gas in cylinder
A	decreases	decreases
B	decreases	increases
C	increases	decreases
D	increases	increases

- 18 The diagram shows four beakers **A**, **B**, **C** and **D**. The beakers contain different amounts of the same liquid at the same temperature. The beakers are left next to each other on a laboratory bench overnight. The diagrams are all drawn to the same scale.

From which beaker does the largest quantity of liquid evaporate?

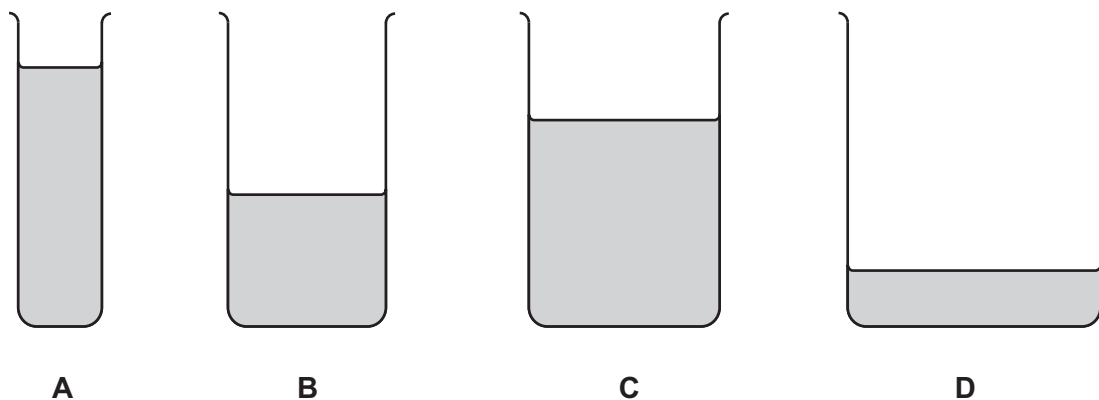

- 19 Which line in the table shows the relative expansion of the three states of matter from the most expansion to the least expansion?

	most expansion			least expansion		
A	solids	>	liquids	>	gases	
B	solids	>	gases	>	liquids	
C	gases	>	liquids	>	solids	
D	gases	>	solids	>	liquids	

- 20 The diagram shows a liquid-in-glass thermometer.

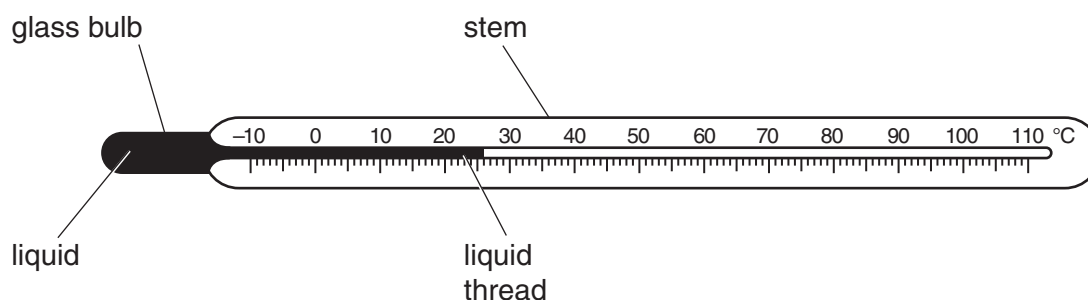

Which two features both affect the sensitivity of the thermometer?

- A** mass of liquid and diameter of liquid thread
- B** mass of liquid and length of stem
- C** thickness of glass bulb and diameter of liquid thread
- D** thickness of glass bulb and length of stem

21 A student wishes to calculate the specific heat capacity of copper.

He has a block of copper and an electrical heater. He knows the power of the heater.

Which other apparatus does he need?

	balance	stop watch	thermometer	
A	✓	✓	✓	key ✓ = needed x = not needed
B	✓	✓	x	
C	✓	x	✓	
D	x	✓	✓	

22 A mass of 0.20 kg of a substance is initially solid.

It is heated at a steady rate of 500 W.

The graph shows how the temperature of the substance changes with time.

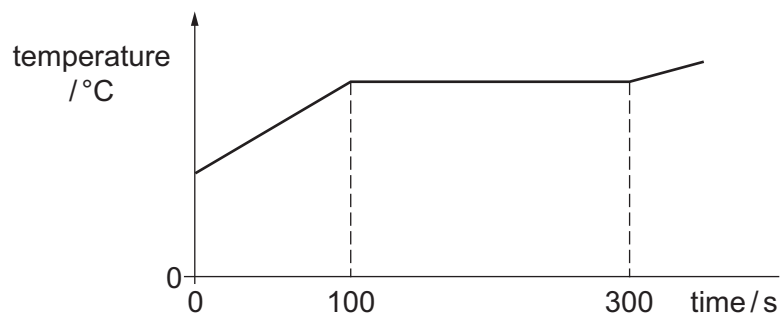

What is the specific latent heat of fusion of the substance?

- A** 20 000 J/kg
- B** 30 000 J/kg
- C** 500 000 J/kg
- D** 750 000 J/kg

23 The diagram shows some ice being used to lower the temperature of some warm water.

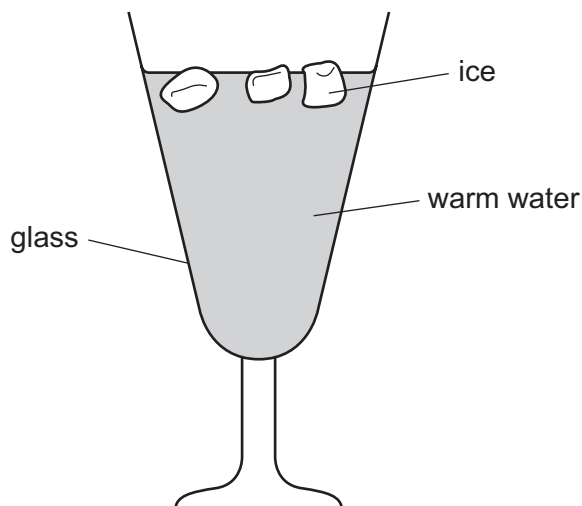

What is the main process by which the water at the bottom of the glass becomes cool?

- A condensation
- B conduction
- C convection
- D radiation

24 The diagrams show water waves that move more slowly after passing into shallow water.

Which diagram shows what happens to the waves?

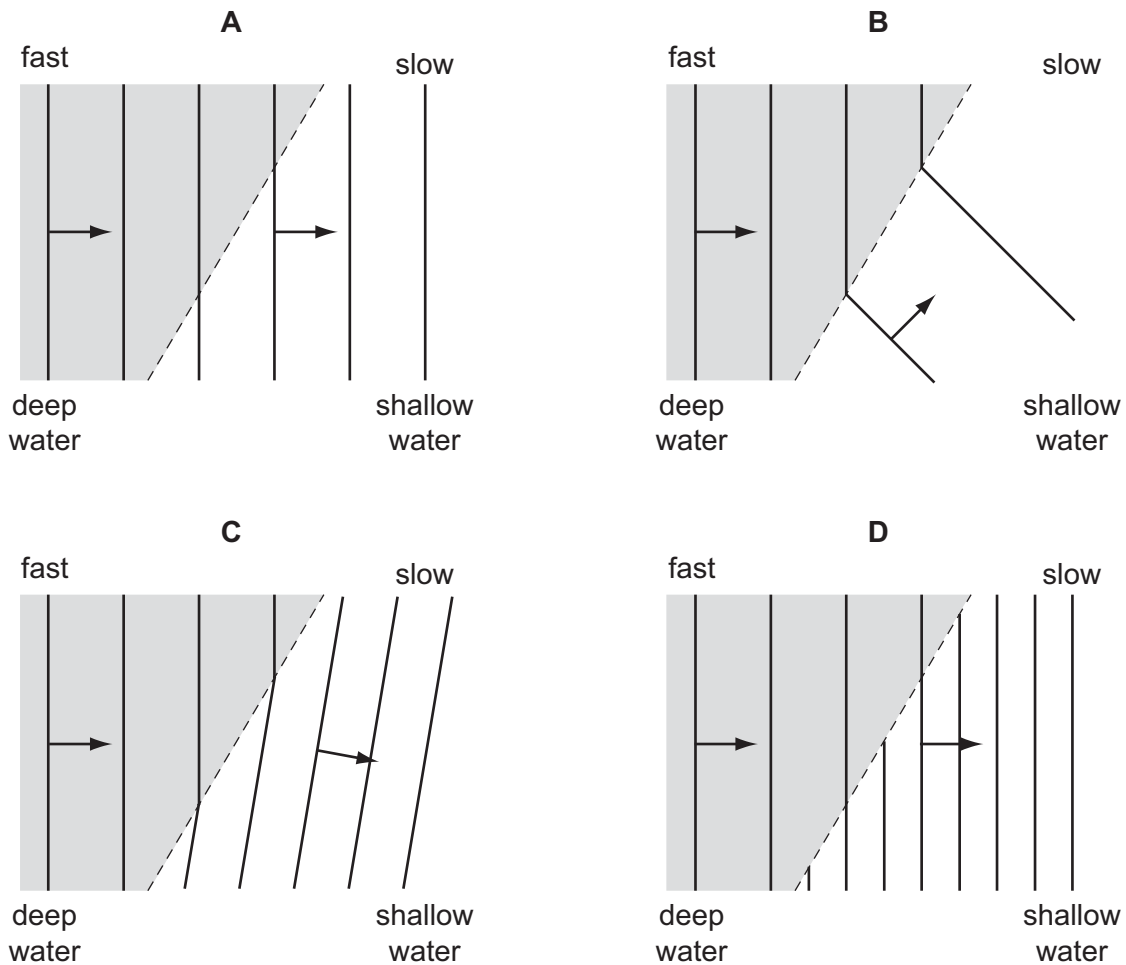

25 The diagram shows a ray of monochromatic light passing through a semi-circular glass block.

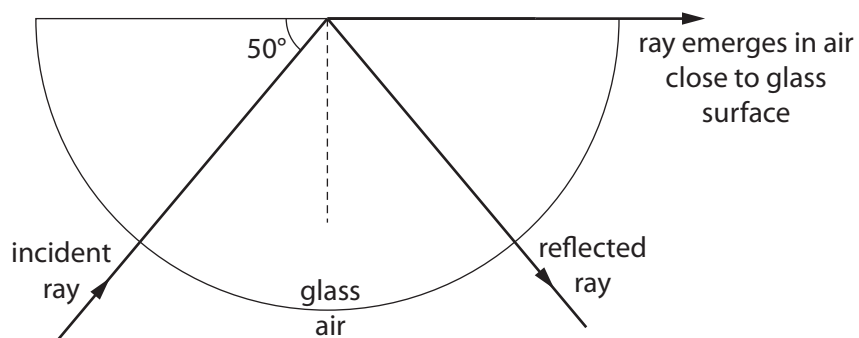

What is the refractive index of the glass?

- A 0.64 B 0.77 C 1.31 D 1.56

26 An object O is placed close to a thin converging lens.

The diagram represents three rays from the top of O passing through the lens.

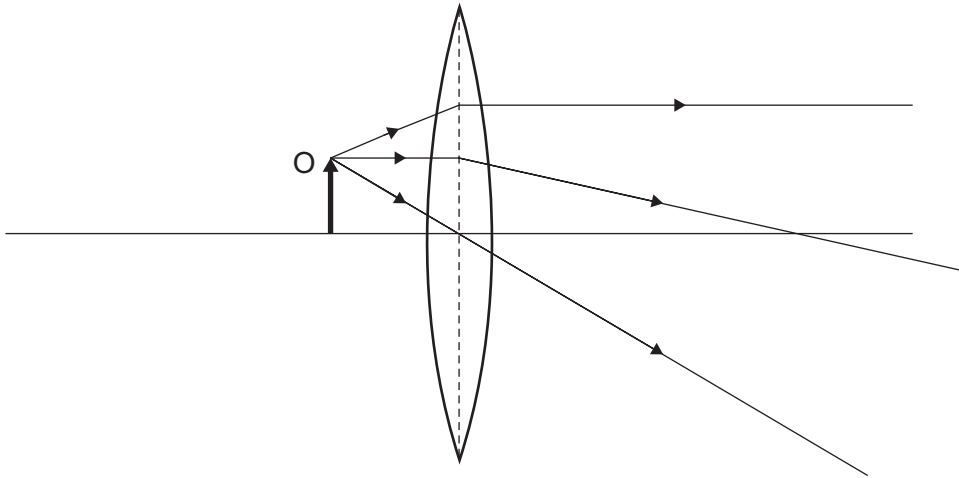

Which type of image is produced by the lens when the object O is in this position?

- A real and diminished
 - B real and enlarged
 - C virtual and diminished
 - D virtual and enlarged
- 27 An echo-sounder on a ship produces a pulse of sound. The echo is received by the echo-sounder after two seconds.

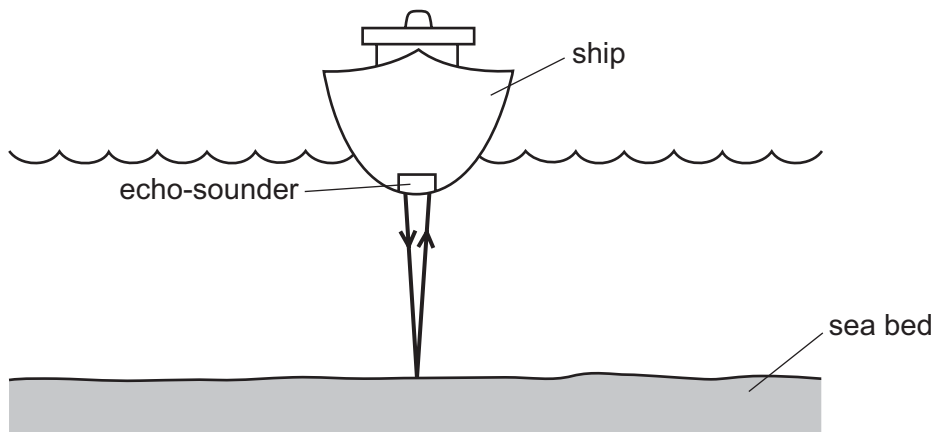

The speed of sound in sea-water is 1500 m/s.

What is the depth of the sea-water below the ship?

- A 750 m
- B 1500 m
- C 3000 m
- D 6000 m

28 The diagram shows apparatus that can be used to make a magnet.

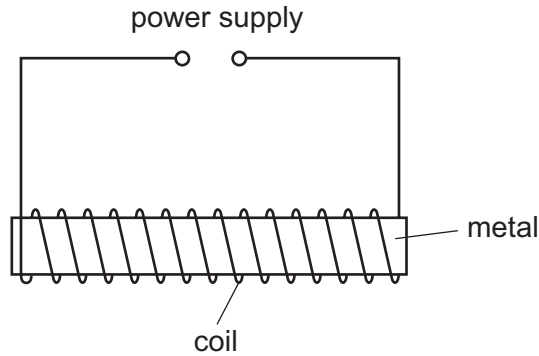

Which metal and which power supply are used to make a **permanent** magnet?

	metal	power supply
A	iron	6 V a.c.
B	iron	6 V d.c.
C	steel	6 V a.c.
D	steel	6 V d.c.

29 A positively charged plastic rod is placed just above a thick metal plate. The metal plate rests on an insulator and is connected to the earth by a wire.

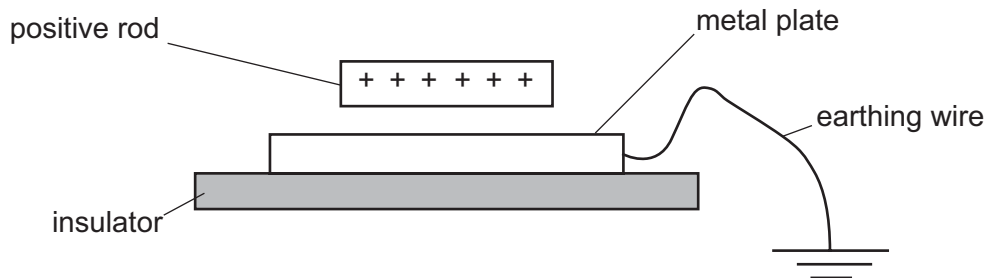

A student disconnects the earthing wire and then removes the positively charged rod.

The experiment is repeated. This time the student removes the positively charged rod and then removes the earthing wire.

Which statement is correct?

- A** When the earthing wire is disconnected first, the metal plate becomes positively charged.
- B** When the earthing wire is disconnected first, the metal plate becomes negatively charged.
- C** When the plastic rod is removed first, the metal plate becomes positively charged.
- D** When the plastic rod is removed first, the metal plate becomes negatively charged.

30 The resistance of a wire depends on its length l and on its cross-sectional area A .

The resistance is

- A directly proportional to l and directly proportional to A .
- B directly proportional to l and inversely proportional to A .
- C inversely proportional to l and directly proportional to A .
- D inversely proportional to l and inversely proportional to A .

31 In the circuit shown, the ammeter reads 2.0A and the voltmeter reads 12V.

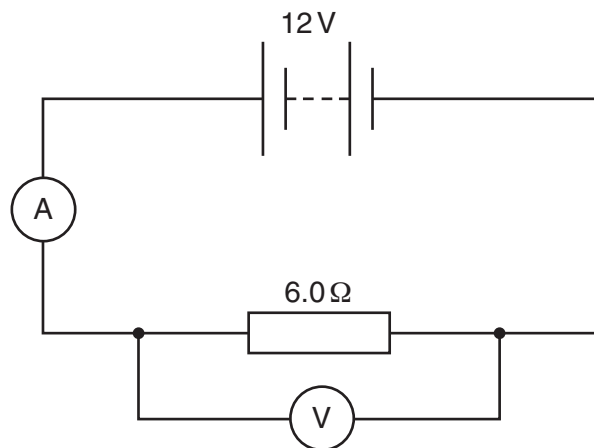

How much energy is transferred by the resistor in 10 seconds?

- A 2.4J
- B 14.4J
- C 240J
- D 1440J

32 The diagram shows part of an electrical circuit.

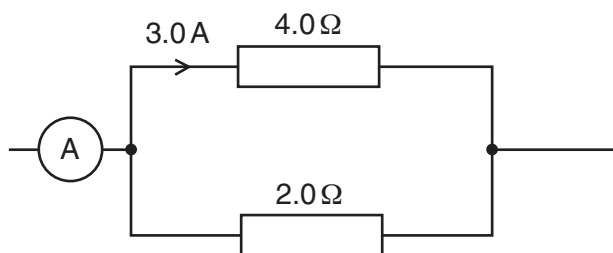

The current in the $4.0\ \Omega$ resistor is $3.0\ \text{A}$.

What is the current in the ammeter?

- A $4.5\ \text{A}$
- B $6.0\ \text{A}$
- C $9.0\ \text{A}$
- D $12.0\ \text{A}$

- 33 The circuit diagram shows a thermistor in a potential divider. A voltmeter is connected across the thermistor.

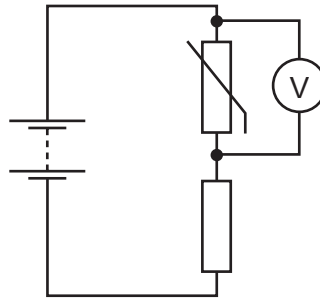

The graph shows how the resistance of the thermistor changes with temperature.

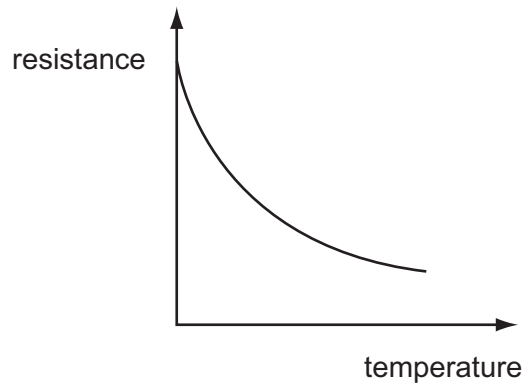

As the thermistor becomes warmer, what happens to its resistance and what happens to the reading on the voltmeter?

	resistance	voltmeter reading
A	decreases	decreases
B	decreases	increases
C	increases	decreases
D	increases	increases

34 A circuit-breaker is designed to protect a circuit which usually carries a current of 2 A.

The time taken to break the circuit depends on the current, as shown in the graph.

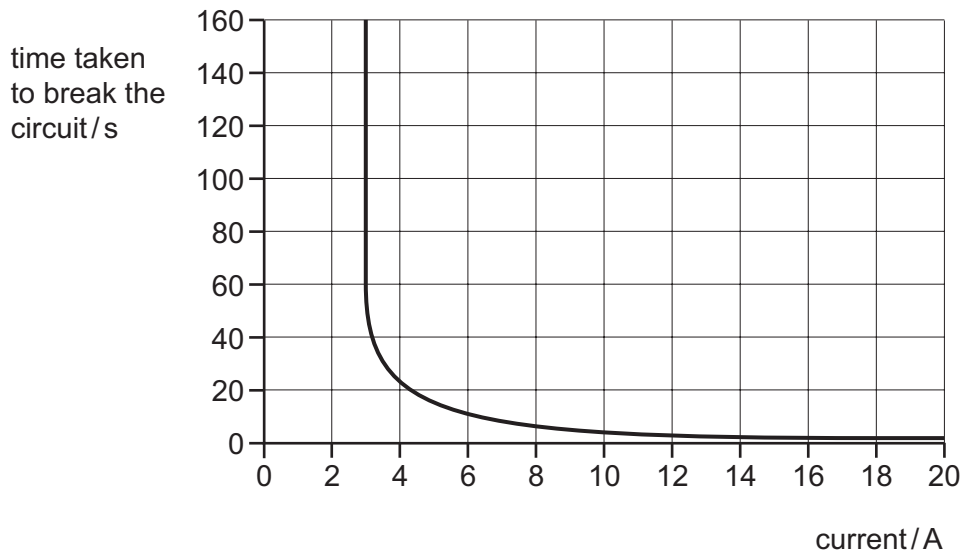

What happens when the current in the circuit is 2 A and what happens when the current is 18 A?

	when the current is 2 A	when the current is 18 A
A	the circuit breaks in less than 5 seconds	the circuit breaks in less than 5 seconds
B	the circuit breaks in less than 5 seconds	the circuit does not break
C	the circuit does not break	the circuit breaks in less than 5 seconds
D	the circuit does not break	the circuit does not break

- 35 A solenoid is connected in series with a sensitive ammeter. The N pole of a magnet is placed next to one end of the solenoid, marked X.

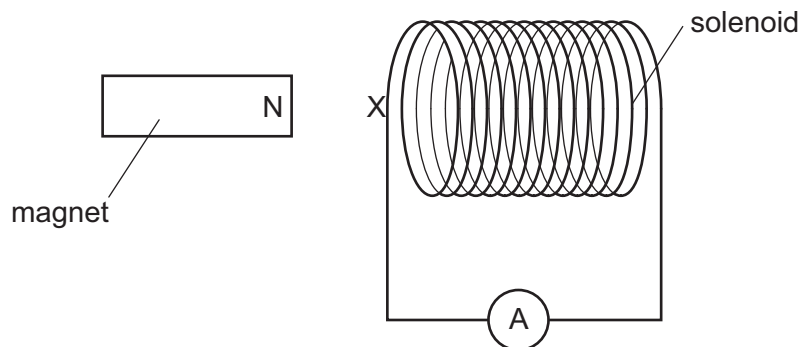

First, the N pole of the magnet is pushed towards X, then the magnet is pulled away from X. During both stages the ammeter deflects.

Which type of magnetic pole is induced at X during these two stages?

	as N pole moves towards X	as N pole moves away from X
A	N pole	N pole
B	N pole	S pole
C	S pole	N pole
D	S pole	S pole

36 The diagram shows a transformer.

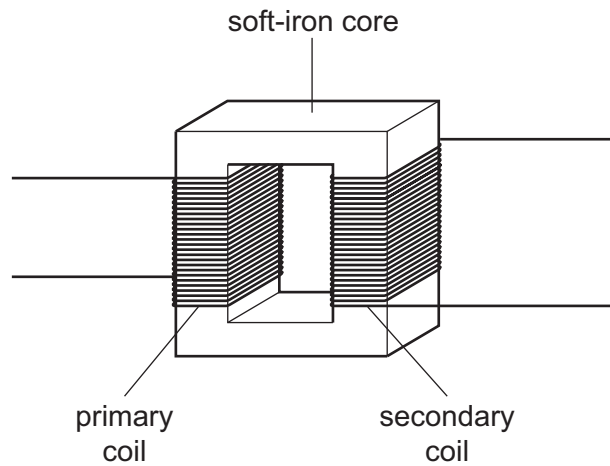

Which row describes the magnetic field in the soft-iron core and the magnetic field in the secondary coil when the transformer is operating?

	magnetic field	
	in soft-iron core	in secondary coil
A	changing	changing
B	changing	constant
C	constant	changing
D	constant	constant

- 37 The graph shows the output of an a.c. generator. The coil in the generator rotates 20 times in one second.

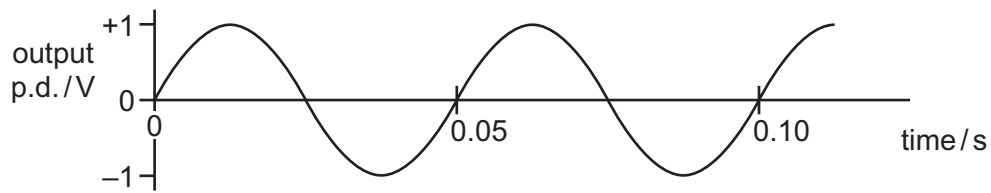

The speed of rotation of the coil steadily increases.

Which graph best shows how the output changes?

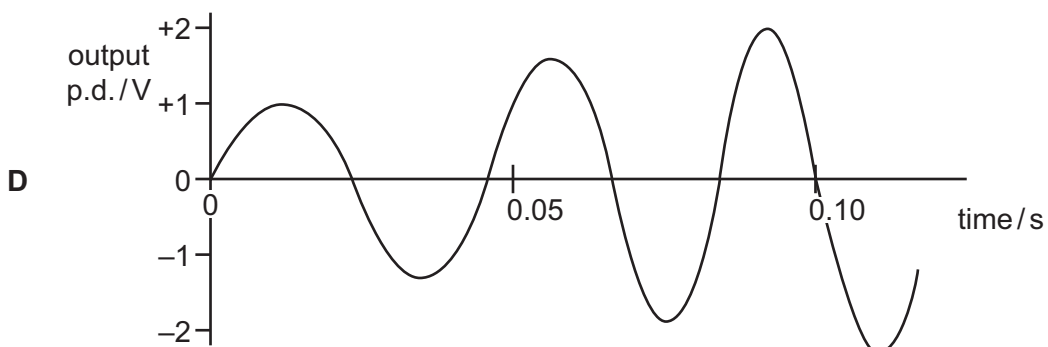
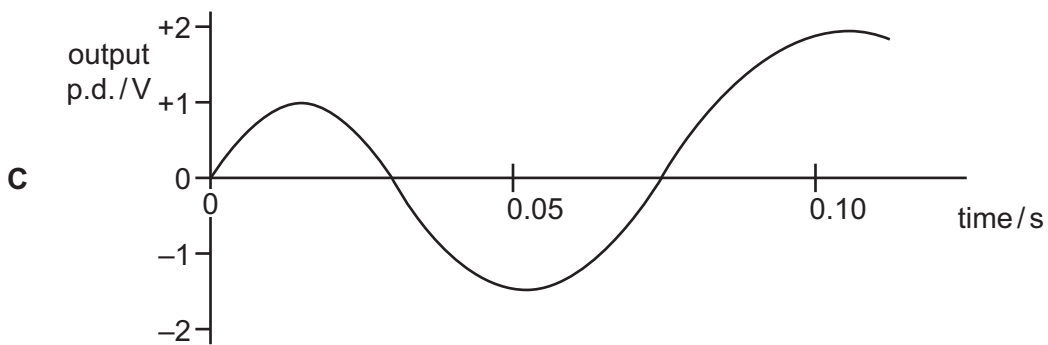
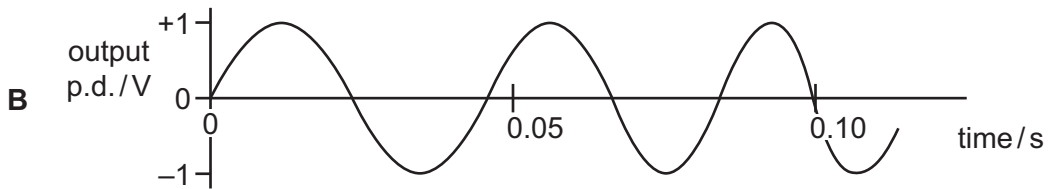
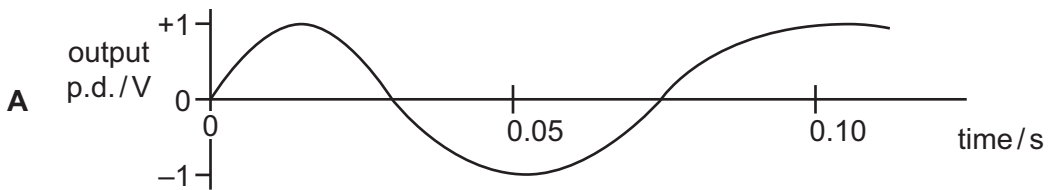

38 The diagram shows a wire placed between two magnetic poles of equal strength.

A current passes through the wire in the direction shown. The current causes a downward force on the wire.

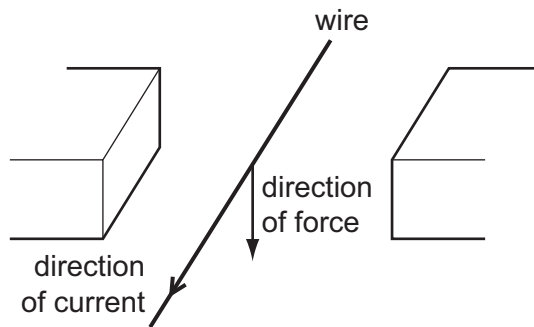

What is the arrangement of the magnetic poles?

- A
- B
- C
- D

- 39 A beam of γ -rays passes between two charged metal plates as shown in the diagram.

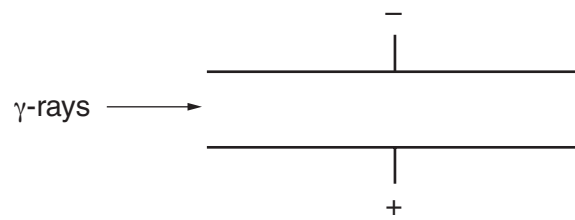

How do the γ -rays pass between the two charged plates?

- A The rays are deflected in a direction perpendicular to the page
 - B The rays are deflected towards the negative plate.
 - C The rays are deflected towards the positive plate.
 - D The rays will continue in the same direction.
- 40 A powder contains 400 mg of a radioactive isotope that emits α -particles.
- The half-life of the isotope is 5 days.
- What mass of this isotope remains after 10 days?
- A 0 mg B 40 mg C 100 mg D 200 mg

BLANK PAGE

Permission to reproduce items where third-party owned material protected by copyright is included has been sought and cleared where possible. Every reasonable effort has been made by the publisher (UCLES) to trace copyright holders, but if any items requiring clearance have unwittingly been included, the publisher will be pleased to make amends at the earliest possible opportunity.

Cambridge International Examinations is part of the Cambridge Assessment Group. Cambridge Assessment is the brand name of University of Cambridge Local Examinations Syndicate (UCLES), which is itself a department of the University of Cambridge.