



Cambridge International AS & A Level

PHYSICS

9702/12

Paper 1 Multiple Choice

October/November 2021

1 hour 15 minutes

You must answer on the multiple choice answer sheet.

You will need: Multiple choice answer sheet
Soft clean eraser
Soft pencil (type B or HB is recommended)

INSTRUCTIONS

- There are **forty** questions on this paper. Answer **all** questions.
- For each question there are four possible answers **A, B, C** and **D**. Choose the **one** you consider correct and record your choice in soft pencil on the multiple choice answer sheet.
- Follow the instructions on the multiple choice answer sheet.
- Write in soft pencil.
- Write your name, centre number and candidate number on the multiple choice answer sheet in the spaces provided unless this has been done for you.
- Do **not** use correction fluid.
- Do **not** write on any bar codes.
- You may use a calculator.

INFORMATION

- The total mark for this paper is 40.
- Each correct answer will score one mark.
- Any rough working should be done on this question paper.

This document has **24** pages. Any blank pages are indicated.



Data

speed of light in free space	$c = 3.00 \times 10^8 \text{ m s}^{-1}$
permeability of free space	$\mu_0 = 4\pi \times 10^{-7} \text{ H m}^{-1}$
permittivity of free space	$\epsilon_0 = 8.85 \times 10^{-12} \text{ F m}^{-1}$ $(\frac{1}{4\pi\epsilon_0} = 8.99 \times 10^9 \text{ m F}^{-1})$
elementary charge	$e = 1.60 \times 10^{-19} \text{ C}$
the Planck constant	$h = 6.63 \times 10^{-34} \text{ J s}$
unified atomic mass unit	$1 \text{ u} = 1.66 \times 10^{-27} \text{ kg}$
rest mass of electron	$m_e = 9.11 \times 10^{-31} \text{ kg}$
rest mass of proton	$m_p = 1.67 \times 10^{-27} \text{ kg}$
molar gas constant	$R = 8.31 \text{ J K}^{-1} \text{ mol}^{-1}$
the Avogadro constant	$N_A = 6.02 \times 10^{23} \text{ mol}^{-1}$
the Boltzmann constant	$k = 1.38 \times 10^{-23} \text{ J K}^{-1}$
gravitational constant	$G = 6.67 \times 10^{-11} \text{ N m}^2 \text{ kg}^{-2}$
acceleration of free fall	$g = 9.81 \text{ m s}^{-2}$

Formulae

uniformly accelerated motion	$s = ut + \frac{1}{2}at^2$ $v^2 = u^2 + 2as$
work done on/by a gas	$W = p\Delta V$
gravitational potential	$\phi = -\frac{Gm}{r}$
hydrostatic pressure	$p = \rho gh$
pressure of an ideal gas	$p = \frac{1}{3}\frac{Nm}{V}\langle c^2 \rangle$
simple harmonic motion	$a = -\omega^2 x$
velocity of particle in s.h.m.	$v = v_0 \cos \omega t$ $v = \pm \omega \sqrt{(x_0^2 - x^2)}$
Doppler effect	$f_o = \frac{f_s v}{v \pm v_s}$
electric potential	$V = \frac{Q}{4\pi\epsilon_0 r}$
capacitors in series	$1/C = 1/C_1 + 1/C_2 + \dots$
capacitors in parallel	$C = C_1 + C_2 + \dots$
energy of charged capacitor	$W = \frac{1}{2}QV$
electric current	$I = Anvq$
resistors in series	$R = R_1 + R_2 + \dots$
resistors in parallel	$1/R = 1/R_1 + 1/R_2 + \dots$
Hall voltage	$V_H = \frac{BI}{ntq}$
alternating current/voltage	$x = x_0 \sin \omega t$
radioactive decay	$x = x_0 \exp(-\lambda t)$
decay constant	$\lambda = \frac{0.693}{t_{\frac{1}{2}}}$

1 Which row shows what all physical quantities must have?

	magnitude	direction	unit
A	✓	✓	✓
B	✓	✓	x
C	✓	x	✓
D	x	x	✓

2 What is an alternative way of expressing an energy of 43 dJ?

- A** $4.3 \times 10^3 \text{ mJ}$
- B** $4.3 \times 10^3 \text{ MJ}$
- C** $4.3 \times 10^{-3} \text{ mJ}$
- D** $4.3 \times 10^{-3} \text{ MJ}$

3 A tennis ball is hit so that it leaves the racket with velocity v at an angle θ to the horizontal.

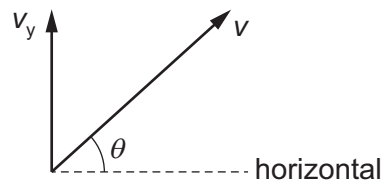

The vertical component of the velocity is v_y .

What is the magnitude of the horizontal component of v ?

- A** $v \sin \theta$
- B** $v_y \cos \theta$
- C** $v_y \sin \theta$
- D** $(v^2 - v_y^2)^{\frac{1}{2}}$

- 4 Four cathode-ray oscilloscope (CRO) screens each display a waveform. The screen and the time-base setting of each CRO is shown.

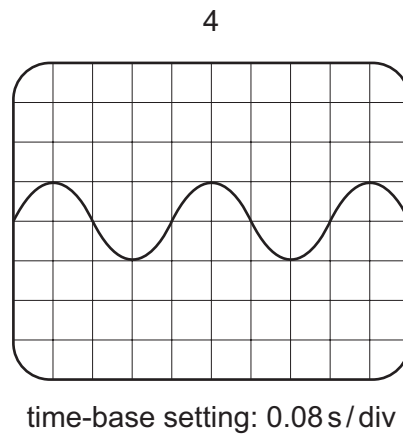
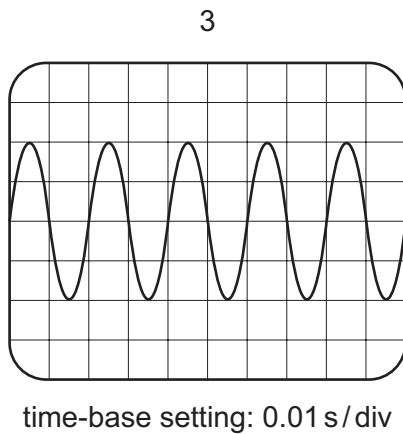
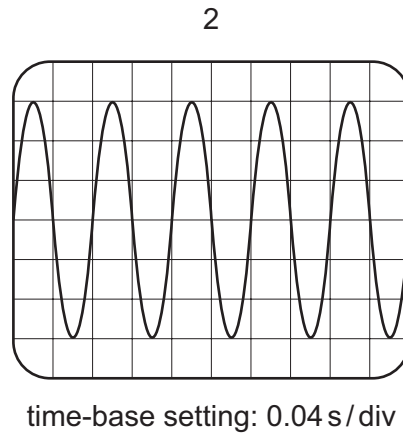
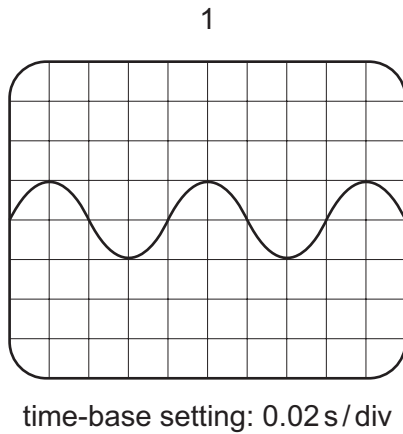

Which screens show waveforms of the same frequency?

- A** 1 and 2 **B** 1 and 3 **C** 1 and 4 **D** 2 and 3
- 5 A student measures the time T for one complete oscillation of a pendulum of length l . Her results are shown in the table.

l/m	T/s
0.420 ± 0.001	1.3 ± 0.1

She uses the formula

$$T = 2\pi\sqrt{\frac{l}{g}}$$

to calculate the acceleration of free fall g .

What is the best estimate of the percentage uncertainty in the value of g ?

- A** 0.02% **B** 4% **C** 8% **D** 16%

- 6 The graph shows the variation with time t of the velocity of a vehicle moving in a straight line.

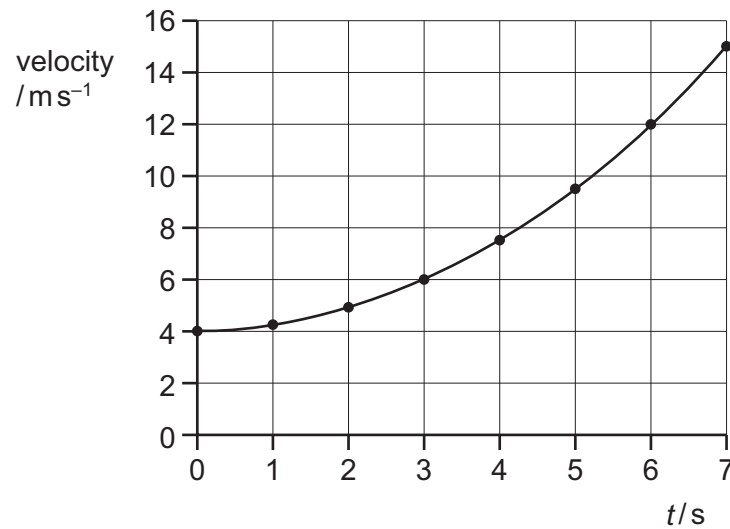

The vehicle, moving at 4.0 ms^{-1} , begins to accelerate at time $t = 0$.

What is the vehicle's acceleration at time $t = 3.0 \text{ s}$?

- A** 0.67 ms^{-2} **B** 1.0 ms^{-2} **C** 1.3 ms^{-2} **D** 2.0 ms^{-2}
- 7 A stone is projected vertically upwards from the ground at an initial speed of 15 ms^{-1} . Air resistance is negligible.
- What is the maximum height reached by the stone?
- A** 0.76 m **B** 11 m **C** 23 m **D** 110 m
- 8 What is meant by the mass of an object?
- A** the property of the object that resists a change in motion
- B** the pull of the Earth on the object
- C** the total number of atoms in the object
- D** the weight of the object

- 9 The diagram shows two parachutists, X and Y, moving vertically downwards.

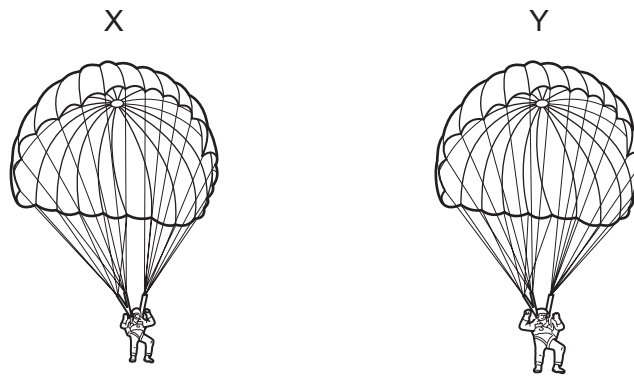

The total mass of parachutist Y and his parachute is twice the total mass of parachutist X and his parachute. At this moment, the air resistance on parachute Y is twice the air resistance on parachute X. Neither parachutist has reached his constant (terminal) velocity.

Which statement describes the acceleration of Y compared with the acceleration of X?

- A** The acceleration of Y is half the acceleration of X.
B The acceleration of Y is the same as the acceleration of X.
C The acceleration of Y is more than the acceleration of X, but less than twice the value.
D The acceleration of Y is twice the acceleration of X.
- 10 The table shows four different collisions between two blocks, each of mass 0.50 kg.

Which collision is perfectly elastic?

	before collision		after collision	
A	$4.0 \text{ m s}^{-1} \rightarrow$ 0.50 kg	0.0 m s^{-1} 0.50 kg	$2.0 \text{ m s}^{-1} \rightarrow$ 0.50 kg 0.50 kg	
B	$2.0 \text{ m s}^{-1} \rightarrow$ 0.50 kg	$\leftarrow 2.0 \text{ m s}^{-1}$ 0.50 kg	0.0 m s^{-1} 0.50 kg 0.50 kg	
C	$2.0 \text{ m s}^{-1} \rightarrow$ 0.50 kg	$\leftarrow 1.0 \text{ m s}^{-1}$ 0.50 kg	$\leftarrow 2.0 \text{ m s}^{-1}$ 0.50 kg	$3.0 \text{ m s}^{-1} \rightarrow$ 0.50 kg
D	$4.0 \text{ m s}^{-1} \rightarrow$ 0.50 kg	$1.0 \text{ m s}^{-1} \rightarrow$ 0.50 kg	$1.0 \text{ m s}^{-1} \rightarrow$ 0.50 kg	$4.0 \text{ m s}^{-1} \rightarrow$ 0.50 kg

- 11 A cylindrical block of wood has cross-sectional area A and weight W . It is totally immersed in water with its axis vertical. The block experiences pressures p_t and p_b at its top and bottom surfaces respectively.

What is the upthrust on the block?

- A $(p_b - p_t)$
 B $(p_b - p_t)A$
 C $(p_b - p_t)A - W$
 D $(p_b - p_t)A + W$

- 12 Two forces, each of magnitude F , act on a disc of diameter s , as shown.

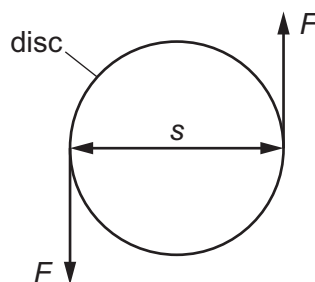

What is the torque exerted on the disc?

- A zero B $\frac{1}{2}Fs$ C Fs D $2Fs$

- 13 A mass of 500 g is attached at one end of a rod of length 1.50 m. The rod is pivoted at a distance of 25 cm from the other end. The rod is horizontal.

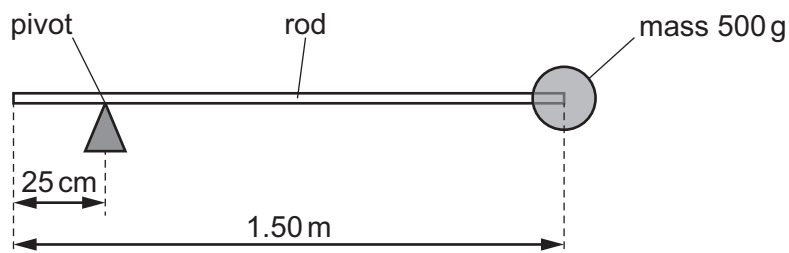

What is the moment about the pivot due to the mass?

- A 0.63 Nm B 1.2 Nm C 6.1 Nm D 7.4 Nm

- 14 A beam QR is held in position by a wire PQ. The structure is used to form a crane supporting a stationary load of 4.0 kN, as shown.

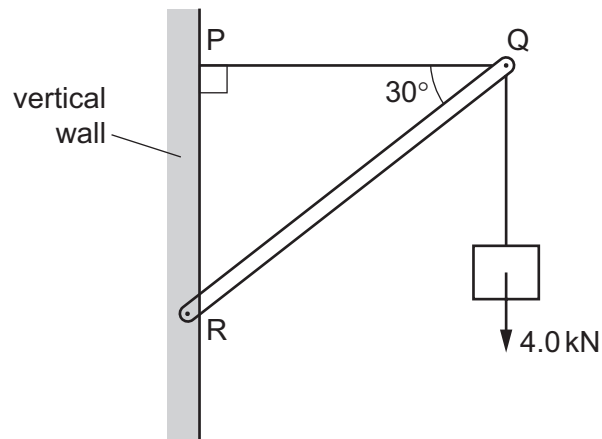

What is the force exerted by the beam QR on point Q?

- A** 4.0 kN **B** 4.6 kN **C** 6.9 kN **D** 8.0 kN

15 A metal cylinder, totally immersed in water, is hung from a newton meter.

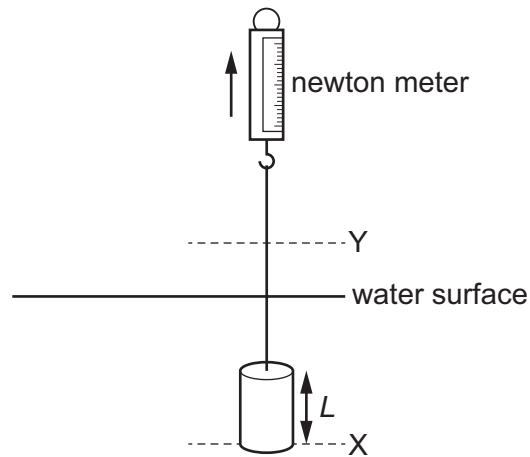

The cylinder, of height L , is slowly raised vertically by lifting the newton meter.

As the base of the cylinder moves from line X in the water to line Y above the surface of the water, the reading R on the newton meter is recorded. The velocity of the cylinder is constant.

Which graph best shows the variation of R with the distance d of the base of the cylinder from line X ?

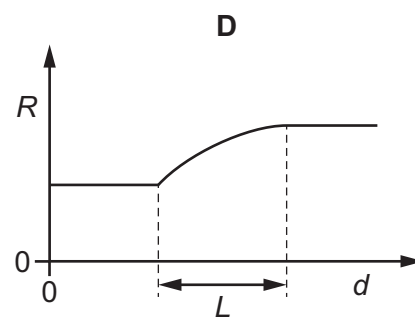
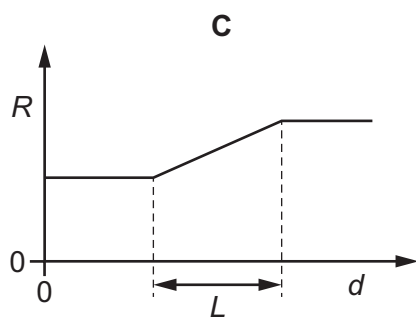
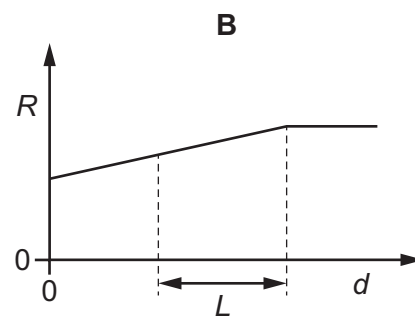
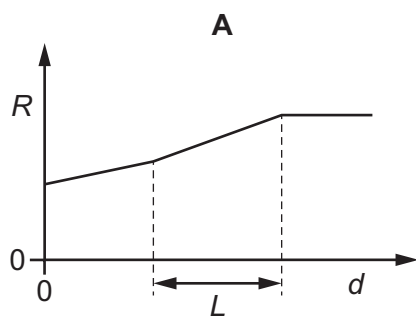

- 16 A ball is thrown vertically upwards into the air. It rises to the top of its path before beginning to fall vertically downwards.

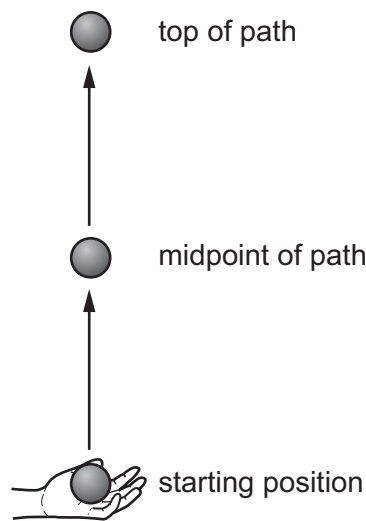

Assume that the gravitational potential energy of the ball is zero at its starting position.

Which statement about the ball is **not** correct?

- A As it rises, its kinetic energy is transferred to gravitational potential energy.
- B At the midpoint of its path, its gravitational potential energy is equal to its initial kinetic energy.
- C At the top of its path, its kinetic energy is zero.
- D At the top of its path, its total energy is less than its initial total energy.
- 17 An object slides with constant velocity across a horizontal sheet of ice. Friction is negligible.

A constant horizontal force of 2.1 N is then applied to the object as shown.

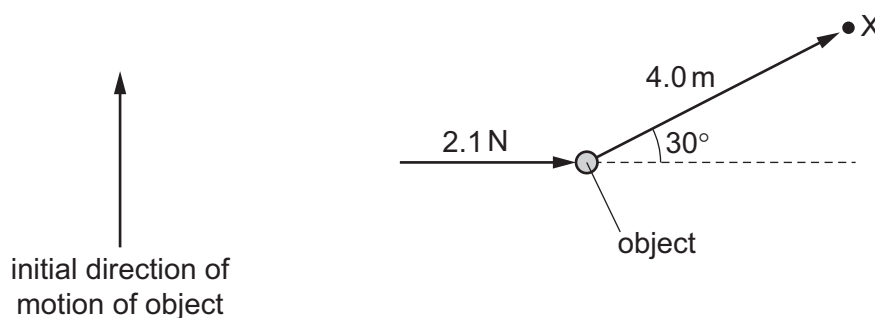

A short time after applying the force, the object reaches point X at a displacement of 4.0 m from its position when the force was first applied.

What is the work done by the force on the object as it travels to point X?

- A 4.2 J B 4.8 J C 7.3 J D 8.4 J

- 18 The energy conversions inside a power station burning fossil fuel can be simplified as shown.

chemical energy $W \rightarrow$ thermal energy $X \rightarrow$ electrical energy Y

Which expression gives the efficiency of the power station?

- A $\frac{Y}{W}$ B $\frac{Y}{(W+X)}$ C $\frac{Y}{X}$ D $\frac{Y}{(W+X+Y)}$

- 19 Car X is travelling at half the speed of car Y. Car X has twice the mass of car Y.

Which statement is correct?

- A Car X has half the kinetic energy of car Y.
B Car X has one quarter of the kinetic energy of car Y.
C Car X has twice the kinetic energy of car Y.
D The two cars have the same kinetic energy.

- 20 The total weight of a motorbike and rider is 1800 N. The motorbike travels in a straight line at constant speed up a hill at an angle of 30° to the horizontal.

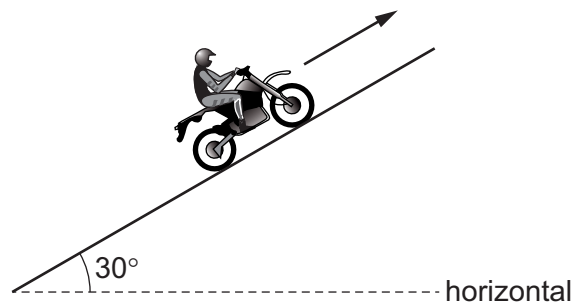

The useful output power of the motorbike is 36 000 W. The total resistive force due to air resistance and friction on the motorbike and rider is 2400 N.

What is the speed of the motorbike?

- A 8.6 ms^{-1} B 11 ms^{-1} C 15 ms^{-1} D 24 ms^{-1}

21 Three springs are arranged vertically as shown.

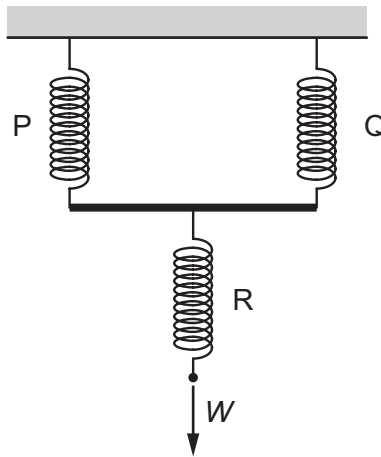

Springs P and Q are identical and each has spring constant k . Spring R has spring constant $3k$.

What is the increase in the overall length of the arrangement when a force W is applied as shown?

A $\frac{5W}{6k}$

B $\frac{4W}{3k}$

C $\frac{7}{2}kW$

D $4kW$

- 22 A length of metal wire is attached to a fixed point and hangs vertically. Masses are then suspended from the wire. Assume that the cross-sectional area of the wire remains constant.

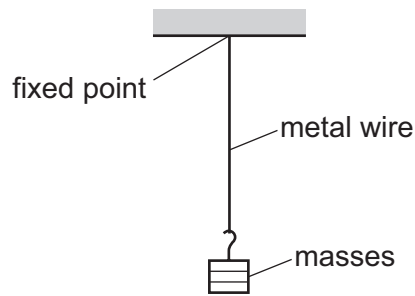

A stress–strain graph for the wire is plotted, as shown.

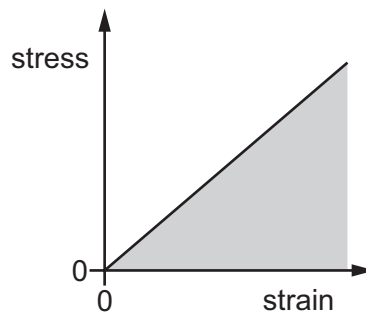

What is represented by the shaded area under the graph?

- A** strain energy in the wire
- B** $\frac{\text{strain energy in the wire}}{\text{cross-sectional area of the wire}}$
- C** $\frac{\text{strain energy in the wire}}{\text{original length of the wire}}$
- D** $\frac{\text{strain energy in the wire}}{\text{original volume of the wire}}$
- 23 The table contains descriptions and examples of waves.

Which row is correct?

	description of wave	example
A	oscillations are parallel to the direction of energy transfer	gamma-rays
B	oscillations are parallel to the direction of energy transfer	ultraviolet waves
C	oscillations are perpendicular to the direction of energy transfer	sound waves
D	oscillations are perpendicular to the direction of energy transfer	X-rays

- 24 A sound wave from a loudspeaker is reflected back along its original path by a reflector.

A microphone is initially at point X where the sound intensity is a minimum, as shown.

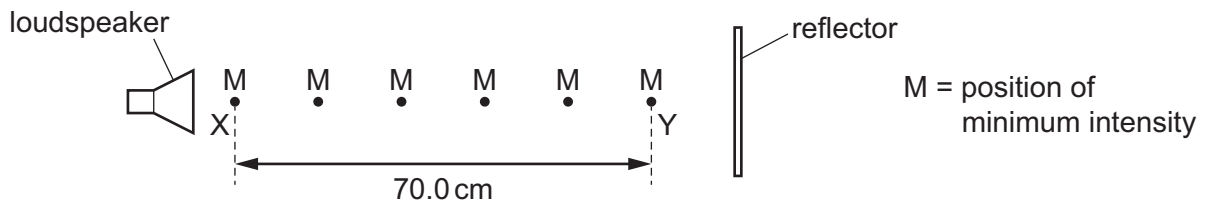

The microphone is moved towards the reflector and passes through four more intensity minima until reaching a fifth minimum at point Y. The distance XY is 70.0 cm.

What is the wavelength of the sound?

- A 11.7 cm B 14.0 cm C 23.3 cm D 28.0 cm
- 25 A train travels in a straight line at a constant speed of 30 ms^{-1} . The train's horn continuously emits sound of frequency 2400 Hz.

A stationary observer stands next to the train track. The train approaches the stationary observer, passes him and then moves away.

The speed of sound is 340 ms^{-1} .

What is the maximum difference in the frequencies of the sound heard by the stationary observer?

- A 190 Hz B 230 Hz C 430 Hz D 460 Hz
- 26 Electromagnetic waves of frequency 30 THz are in a vacuum.

In which region of the electromagnetic spectrum are the waves?

- A infrared
B microwave
C ultraviolet
D visible light

- 27 A stationary wave is produced on a string that is stretched between two fixed points that are a distance of 1.35 m apart, as shown.

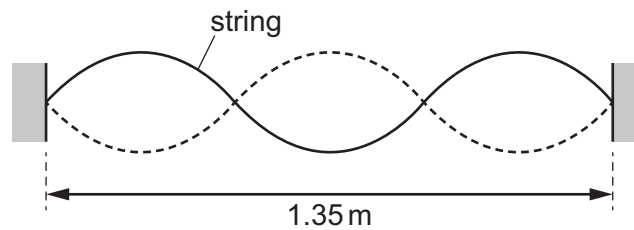

The speed of the waves on the string is 450 m s^{-1} .

What is the frequency of oscillation of the stationary wave?

- A 333 Hz B 405 Hz C 500 Hz D 1000 Hz
- 28 A beam of laser light is directed towards a narrow slit.

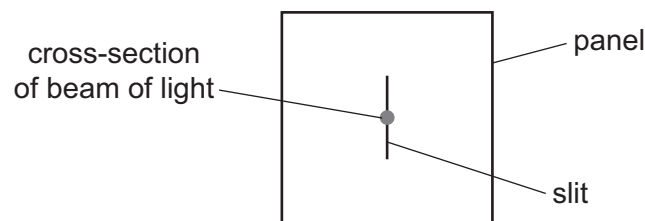

After emerging from the other side of the slit, the diffracted light then falls on a screen.

What is the pattern of light seen on the screen?

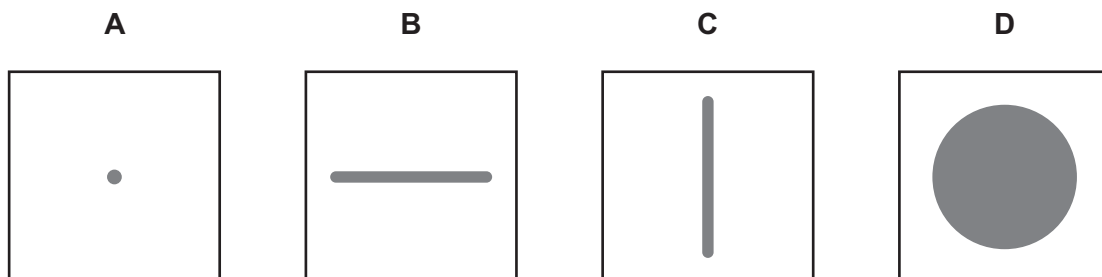

- 29 Two waves, each with a constant amplitude, interfere and produce an interference pattern. The pattern has minima at fixed points where the displacement is zero at all times.

Which statement describes the two waves?

- A They must be coherent and of the same amplitude.
 B They must be coherent but not necessarily of the same amplitude.
 C They must be of the same amplitude but not necessarily coherent.
 D They must not be coherent or of the same amplitude.

- 30 Light of wavelength 5.5×10^{-7} m is incident normally on a diffraction grating.

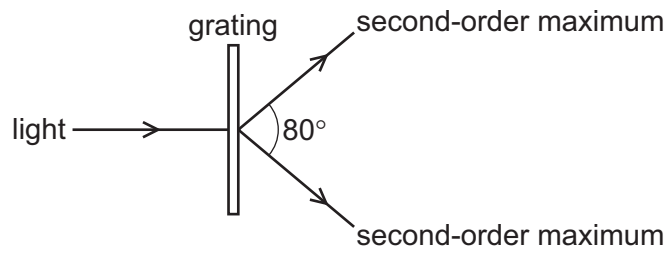

The angle between the second-order diffraction maxima is 80° , as shown.

What is the number of lines per metre of the diffraction grating?

- A** 5.8×10^5 lines per metre
B 9.0×10^5 lines per metre
C 1.2×10^6 lines per metre
D 2.3×10^6 lines per metre
- 31 Four diagrams representing the electric field between two oppositely charged point charges are shown.

Which diagram correctly shows the electric field lines?

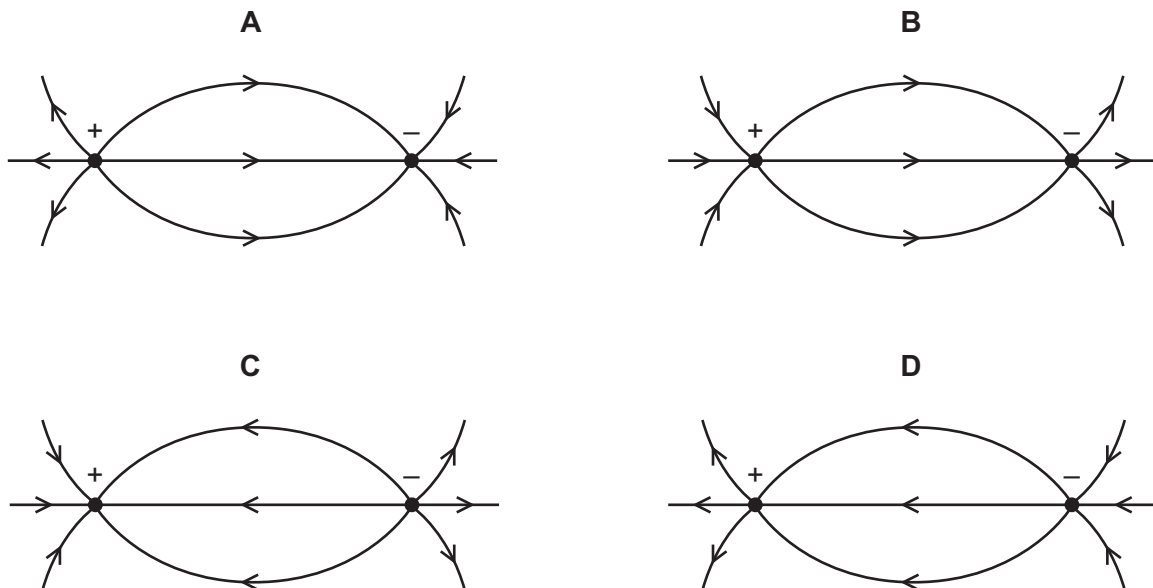

- 32** A proton enters the uniform electric field between two parallel vertical metal plates in a vacuum. One plate is at a potential of 0 V and the other plate is at a potential of +10 V, as shown.

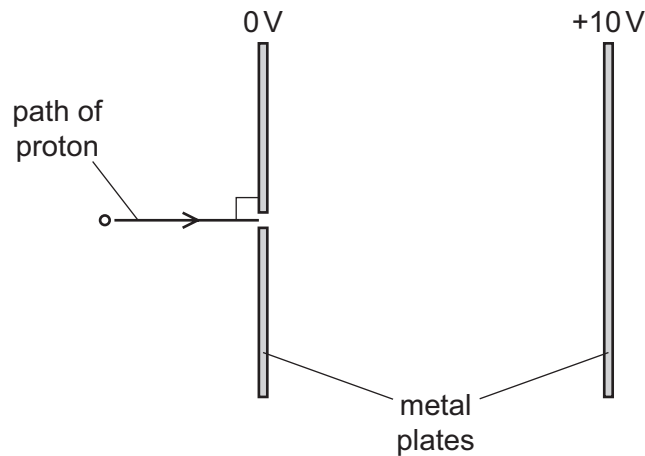

What is the initial change in the motion of the proton caused by the electric field, immediately after the proton enters the field?

- A** It begins to move downwards.
 - B** It begins to move upwards.
 - C** Its speed decreases.
 - D** Its speed increases.
- 33** What is a description of the coulomb?
- A** the electric charge of one electron
 - B** the electric charge transferred by a current of one ampere in one second
 - C** the kinetic energy gained by an electron accelerated through a potential difference of one volt
 - D** the kinetic energy of an electron moving at a speed of one metre per second

- 34 A battery of electromotive force (e.m.f.) 10 V and internal resistance $5.0\ \Omega$ is connected to a $5.0\ \Omega$ load resistor.

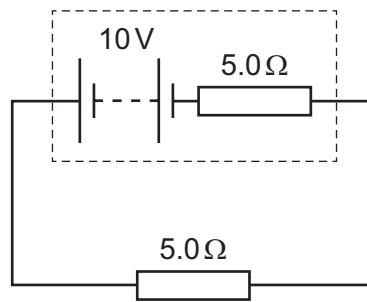

Which change occurs when the $5.0\ \Omega$ load resistor is replaced with a $50\ \Omega$ load resistor?

- A** The current in the circuit increases.
B The potential difference across the load resistor increases.
C The power dissipated in the internal resistance of the battery increases.
D The total power dissipated in the circuit increases.
- 35 The graphs show the variation with potential difference V of the current I for three circuit components.

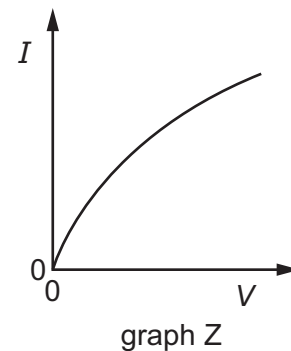
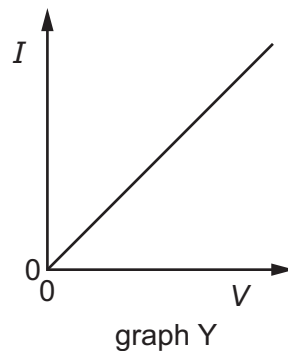
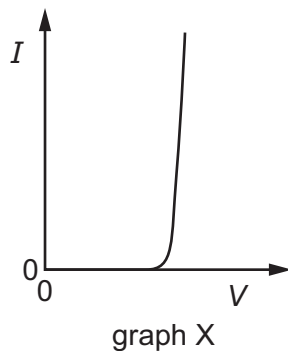

The components are a metal wire at constant temperature, a semiconductor diode and a filament lamp.

Which row correctly identifies these graphs?

	metal wire at constant temperature	semiconductor diode	filament lamp
A	X	Z	Y
B	Y	X	Z
C	Y	Z	X
D	Z	X	Y

- 36** The electromotive force (e.m.f.) of a cell is 6.0V. It has negligible internal resistance and is connected across a resistor. The potential difference (p.d.) across the resistor is also 6.0V.

The e.m.f. and the p.d. have the same numerical value but represent different processes.

Which statement about the different processes is correct?

- A** The e.m.f. is the energy transferred from chemical energy to electrical energy in the cell and the p.d. is the energy transferred from electrical energy to thermal energy in the resistor.
- B** The p.d. is the energy transferred from chemical energy to electrical energy in the cell and the e.m.f. is the energy transferred from electrical energy to thermal energy in the resistor.
- C** The e.m.f. is the energy transferred per unit charge from chemical energy to electrical energy in the cell and the p.d. is the energy transferred per unit charge from electrical energy to thermal energy in the resistor.
- D** The p.d. is the energy transferred per unit charge from chemical energy to electrical energy in the cell and the e.m.f. is the energy transferred per unit charge from electrical energy to thermal energy in the resistor.
- 37** A battery of negligible internal resistance is connected to three resistors, as shown.

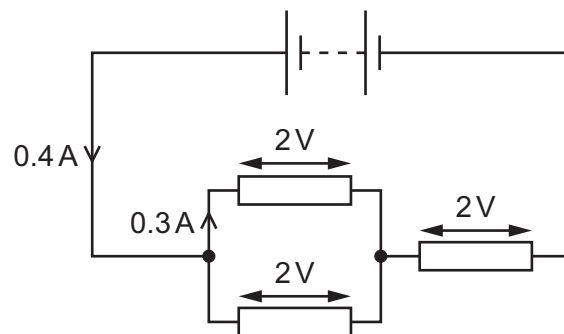

The potential difference across each resistor is 2V.

The current from the battery is 0.4A and the current through one of the resistors connected in parallel is 0.3A.

What is the current through the other resistor connected in parallel and what is the electromotive force (e.m.f.) of the battery?

	current / A	e.m.f. / V
A	0.1	4
B	0.3	4
C	0.1	6
D	0.3	6

- 38 A battery of electromotive force (e.m.f.) 9.0 V and internal resistance $1.0\ \Omega$ is connected to a fixed resistor of resistance $5.0\ \Omega$ and a potentiometer of maximum resistance $3.0\ \Omega$, as shown.

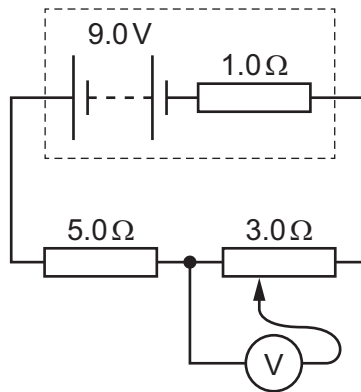

The sliding contact of the potentiometer is moved over its full range of movement.

What is the maximum value of the potential difference that is measured by the voltmeter?

- A** 3.0 V **B** 3.4 V **C** 4.5 V **D** 5.4 V
- 39 An unstable nucleus decays by emitting a β^+ particle.
- Which statement is correct?
- A** An antineutrino is also emitted.
B A neutron changes into a proton.
C Mass–energy is conserved.
D The nucleon number is not conserved.
- 40 Which statement is **not** correct?
- A** An antineutrino is a fundamental particle.
B An electron is made up of a quark and an antiquark.
C A neutrino is a lepton.
D A neutron is composed of three quarks.

BLANK PAGE

BLANK PAGE

BLANK PAGE

Permission to reproduce items where third-party owned material protected by copyright is included has been sought and cleared where possible. Every reasonable effort has been made by the publisher (UCLES) to trace copyright holders, but if any items requiring clearance have unwittingly been included, the publisher will be pleased to make amends at the earliest possible opportunity.

To avoid the issue of disclosure of answer-related information to candidates, all copyright acknowledgements are reproduced online in the Cambridge Assessment International Education Copyright Acknowledgements Booklet. This is produced for each series of examinations and is freely available to download at www.cambridgeinternational.org after the live examination series.

Cambridge Assessment International Education is part of the Cambridge Assessment Group. Cambridge Assessment is the brand name of the University of Cambridge Local Examinations Syndicate (UCLES), which itself is a department of the University of Cambridge.