

---

**PHYSICS**

**9702/12**

Paper 1 Multiple Choice

**May/June 2019**

**1 hour 15 minutes**

Additional Materials:      Multiple Choice Answer Sheet  
   Soft clean eraser  
   Soft pencil (type B or HB is recommended)

\* 2 8 5 2 6 0 5 0 2 0 \*

---

**READ THESE INSTRUCTIONS FIRST**

Write in soft pencil.

Do not use staples, paper clips, glue or correction fluid.

Write your name, centre number and candidate number on the Answer Sheet in the spaces provided unless this has been done for you.

**DO NOT WRITE IN ANY BARCODES.**

There are **forty** questions on this paper. Answer **all** questions. For each question there are four possible answers **A, B, C** and **D**.

Choose the **one** you consider correct and record your choice in **soft pencil** on the separate Answer Sheet.

**Read the instructions on the Answer Sheet very carefully.**

Each correct answer will score one mark. A mark will not be deducted for a wrong answer.

Any working should be done in this booklet.

Electronic calculators may be used.

---

This document consists of **20** printed pages and **4** blank pages.

**Data**

speed of light in free space	$c = 3.00 \times 10^8 \text{ m s}^{-1}$
permeability of free space	$\mu_0 = 4\pi \times 10^{-7} \text{ H m}^{-1}$
permittivity of free space	$\epsilon_0 = 8.85 \times 10^{-12} \text{ F m}^{-1}$ $(\frac{1}{4\pi\epsilon_0} = 8.99 \times 10^9 \text{ m F}^{-1})$
elementary charge	$e = 1.60 \times 10^{-19} \text{ C}$
the Planck constant	$h = 6.63 \times 10^{-34} \text{ J s}$
unified atomic mass unit	$1 \text{ u} = 1.66 \times 10^{-27} \text{ kg}$
rest mass of electron	$m_e = 9.11 \times 10^{-31} \text{ kg}$
rest mass of proton	$m_p = 1.67 \times 10^{-27} \text{ kg}$
molar gas constant	$R = 8.31 \text{ J K}^{-1} \text{ mol}^{-1}$
the Avogadro constant	$N_A = 6.02 \times 10^{23} \text{ mol}^{-1}$
the Boltzmann constant	$k = 1.38 \times 10^{-23} \text{ J K}^{-1}$
gravitational constant	$G = 6.67 \times 10^{-11} \text{ N m}^2 \text{ kg}^{-2}$
acceleration of free fall	$g = 9.81 \text{ m s}^{-2}$

**Formulae**

uniformly accelerated motion	$s = ut + \frac{1}{2}at^2$ $v^2 = u^2 + 2as$
work done on/by a gas	$W = p\Delta V$
gravitational potential	$\phi = -\frac{Gm}{r}$
hydrostatic pressure	$p = \rho gh$
pressure of an ideal gas	$p = \frac{1}{3}\frac{Nm}{V}\langle c^2 \rangle$
simple harmonic motion	$a = -\omega^2 x$
velocity of particle in s.h.m.	$v = v_0 \cos \omega t$ $v = \pm \omega \sqrt{(x_0^2 - x^2)}$
Doppler effect	$f_o = \frac{f_s v}{v \pm v_s}$
electric potential	$V = \frac{Q}{4\pi\epsilon_0 r}$
capacitors in series	$1/C = 1/C_1 + 1/C_2 + \dots$
capacitors in parallel	$C = C_1 + C_2 + \dots$
energy of charged capacitor	$W = \frac{1}{2}QV$
electric current	$I = Anvq$
resistors in series	$R = R_1 + R_2 + \dots$
resistors in parallel	$1/R = 1/R_1 + 1/R_2 + \dots$
Hall voltage	$V_H = \frac{BI}{ntq}$
alternating current/voltage	$x = x_0 \sin \omega t$
radioactive decay	$x = x_0 \exp(-\lambda t)$
decay constant	$\lambda = \frac{0.693}{t_{\frac{1}{2}}}$

1 What is equivalent to 2000 microvolts?

- A  $2\mu\text{JC}^{-1}$       B 2 mV      C 2 pV      D 2000 mV

2 What is the number of SI base units required to express electric field strength and power?

	electric field strength	power
A	3	3
B	3	2
C	4	2
D	4	3

3 The Planck constant  $h$  has SI units J s.

Which equation could be used to calculate the Planck constant?

A  $h = \frac{DE}{v}$  where  $D$  is distance,  $E$  is energy and  $v$  is velocity

B  $h = \frac{v}{D}$  where  $v$  is velocity and  $D$  is distance

C  $h = \frac{1}{4\pi E}$  where  $E$  is electric field strength

D  $h = \frac{Fr^2}{m}$  where  $F$  is force,  $r$  is radius and  $m$  is mass

- 4 Two cables are attached to a bracket and exert forces as shown.

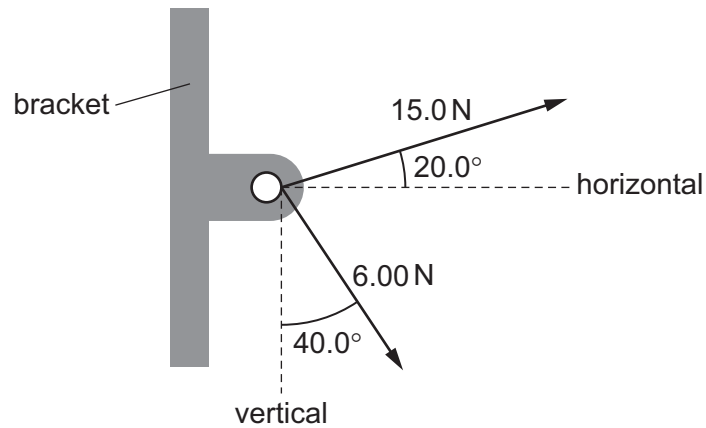

What are the magnitudes of the horizontal and vertical components of the resultant of the two forces?

	horizontal component/N	vertical component/N
<b>A</b>	9.73	0.534
<b>B</b>	9.73	10.2
<b>C</b>	18.0	0.534
<b>D</b>	18.0	10.2

- 5 A student wishes to determine the density  $\rho$  of lead. She measures the mass and diameter of a small sphere of lead:

$$\text{mass} = (0.506 \pm 0.005)\text{g}$$

$$\text{diameter} = (2.20 \pm 0.02)\text{mm}.$$

What is the best estimate of the percentage uncertainty in her calculated value of  $\rho$ ?

- A** 1.7%      **B** 1.9%      **C** 2.8%      **D** 3.7%

- 6 Two quantities  $p$  and  $q$  are directly proportional to each other.

Experimental results are taken and plotted in a graph of  $q$  against  $p$ .

Which graph shows there were random errors in the measurements of  $p$  and  $q$ ?

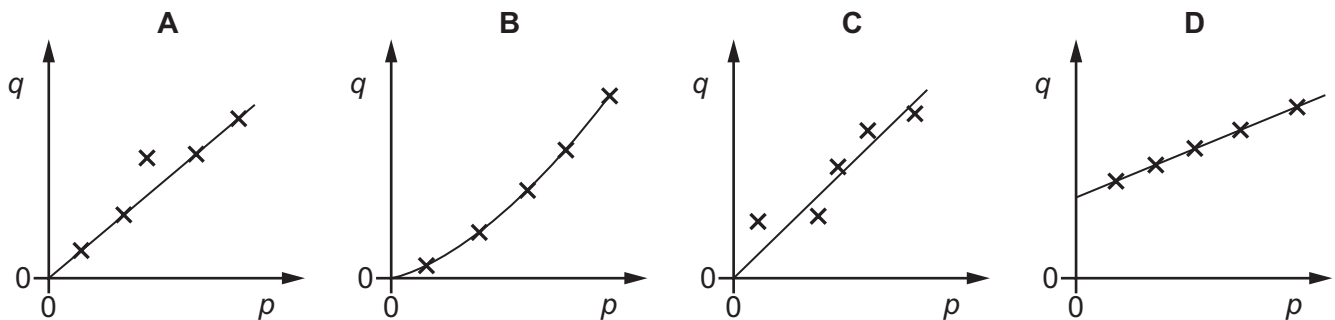

- 7 A man of mass 75.2 kg uses a set of weighing scales to measure his mass three times. He obtains the following readings.

	mass / kg
reading 1	80.2
reading 2	80.1
reading 3	80.2

Which statement best describes the precision and accuracy of the weighing scales?

- A not precise to  $\pm 0.1$  kg and accurate to  $\pm 0.1$  kg
- B not precise to  $\pm 0.1$  kg and not accurate to  $\pm 0.1$  kg
- C precise to  $\pm 0.1$  kg and accurate to  $\pm 0.1$  kg
- D precise to  $\pm 0.1$  kg and not accurate to  $\pm 0.1$  kg

- 8 The graph shows how a physical quantity varies with time.

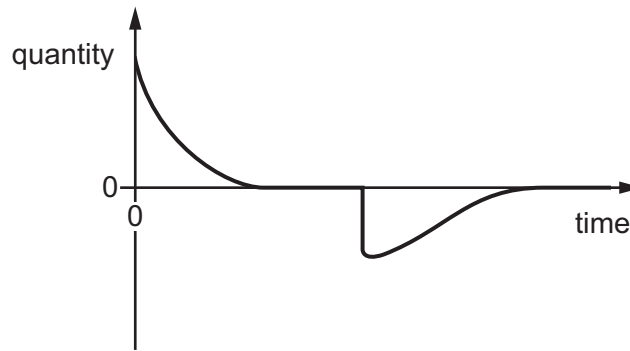

Which event could best be represented by the graph?

- A** the acceleration of a firework rising to a maximum height and falling to the ground
- B** the acceleration of a skydiver leaving an aircraft, falling, opening a parachute and falling to the ground
- C** the speed of a javelin as it leaves an athlete's hand, falls and sinks into the ground
- D** the speed of a high jump athlete leaving the ground, jumping over a bar and descending to the ground
- 9 What describes the mass of an object?
- A** the force the object experiences due to gravity
- B** the momentum of the object before a collision
- C** the resistance of the object to changes in motion
- D** the weight of the object as measured by a balance
- 10 A car has mass  $m$ . A person needs to push the car with force  $F$  in order to give the car acceleration  $a$ . The person needs to push the car with force  $2F$  in order to give the car acceleration  $3a$ .

Which expression gives the constant resistive force opposing the motion of the car?

- A**  $ma$                       **B**  $2ma$                       **C**  $3ma$                       **D**  $4ma$

- 11 Two bar magnets P and Q are mounted on floats which can slide without friction along an air track.

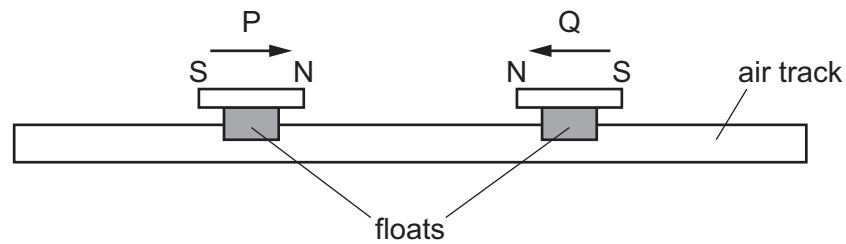

The two magnets slide towards each other along the air track and interact, without making contact.

The relative speed of approach of the magnets is equal to their relative speed of separation.

Which statement about P and Q must be correct?

- A During the interaction between P and Q some of the total kinetic energy is lost.
  - B During the interaction between P and Q some of the total momentum is lost.
  - C The momentum of Q after the interaction is equal to the momentum of P before the interaction.
  - D The values of (kinetic energy of P + kinetic energy of Q) before and after the interaction are equal.
- 12 A submarine descends vertically at constant velocity. The three forces acting on the submarine are viscous drag, upthrust and weight.

Which relationship between their magnitudes is correct?

- A weight < drag
- B weight = drag
- C weight < upthrust
- D weight > upthrust



- 13 A small positive charge can move inside a uniform electric field.

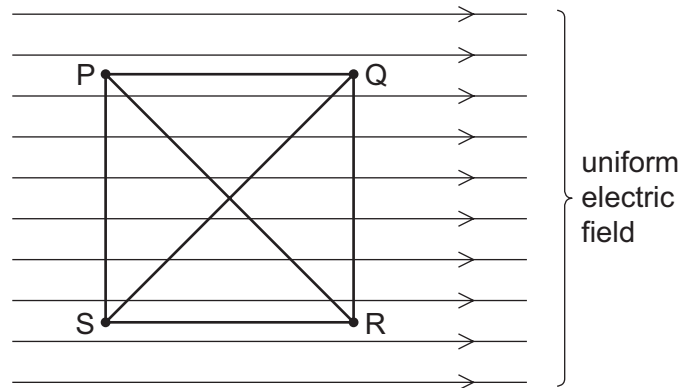

The charge moves along different straight paths between points P, Q, R and S.

Which row gives two paths that result in the same total work done on the charge?

	path 1	path 2
<b>A</b>	P to R	Q to S
<b>B</b>	P to R	P to S
<b>C</b>	S to Q	S to R
<b>D</b>	S to Q	R to P

- 14 A car of mass  $m$  travels at constant speed up a slope at an angle  $\theta$  to the horizontal, as shown in the diagram. Air resistance and friction provide a resistive force  $F$ . The acceleration of free fall is  $g$ .

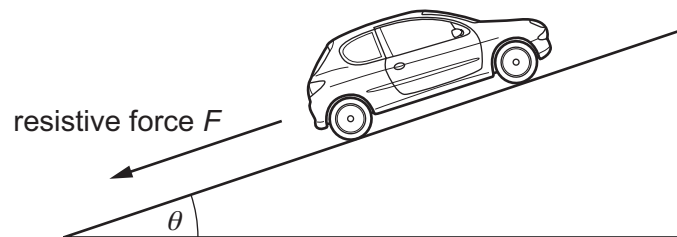

What is the force needed to propel the car at this constant speed?

- A**  $mg \cos \theta$
- B**  $mg \sin \theta$
- C**  $mg \cos \theta + F$
- D**  $mg \sin \theta + F$

- 15 A volume of  $1.5 \text{ m}^3$  of water is mixed with  $0.50 \text{ m}^3$  of alcohol. The density of water is  $1000 \text{ kg m}^{-3}$  and the density of alcohol is  $800 \text{ kg m}^{-3}$ .

The volume of the mixture is  $2.0 \text{ m}^3$ .

What is the density of the mixture?

- A  $850 \text{ kg m}^{-3}$       B  $900 \text{ kg m}^{-3}$       C  $940 \text{ kg m}^{-3}$       D  $950 \text{ kg m}^{-3}$
- 16 A parachutist is falling at constant (terminal) velocity.
- Which statement is **not** correct?
- A Gravitational potential energy is converted into kinetic energy of the air.  
B Gravitational potential energy is converted into kinetic energy of the parachutist.  
C Gravitational potential energy is converted into thermal energy of the air.  
D Gravitational potential energy is converted into thermal energy of the parachutist.
- 17 A combined heat and power (CHP) station generates electrical power and useful heat. The diagram shows the input and output powers for a CHP station.

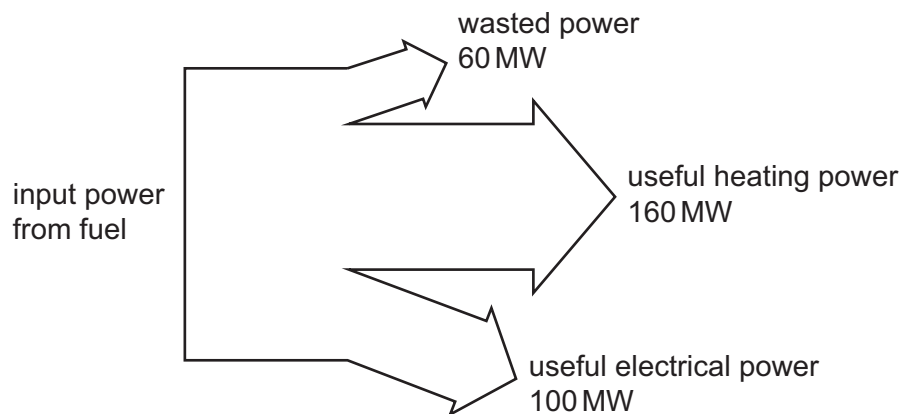

What is the efficiency of the CHP station for producing useful power?

- A 31%      B 38%      C 50%      D 81%

- 18 A bungee jumper jumps off a high bridge, when attached to it by a long elastic rope which obeys Hooke's law.

The gravitational potential energy of the jumper is measured relative to the lowest point reached by the jumper.

Which graph shows the variation of the gravitational potential energy of the jumper, and the elastic potential energy in the rope, with the vertical distance fallen from the top of the bridge?

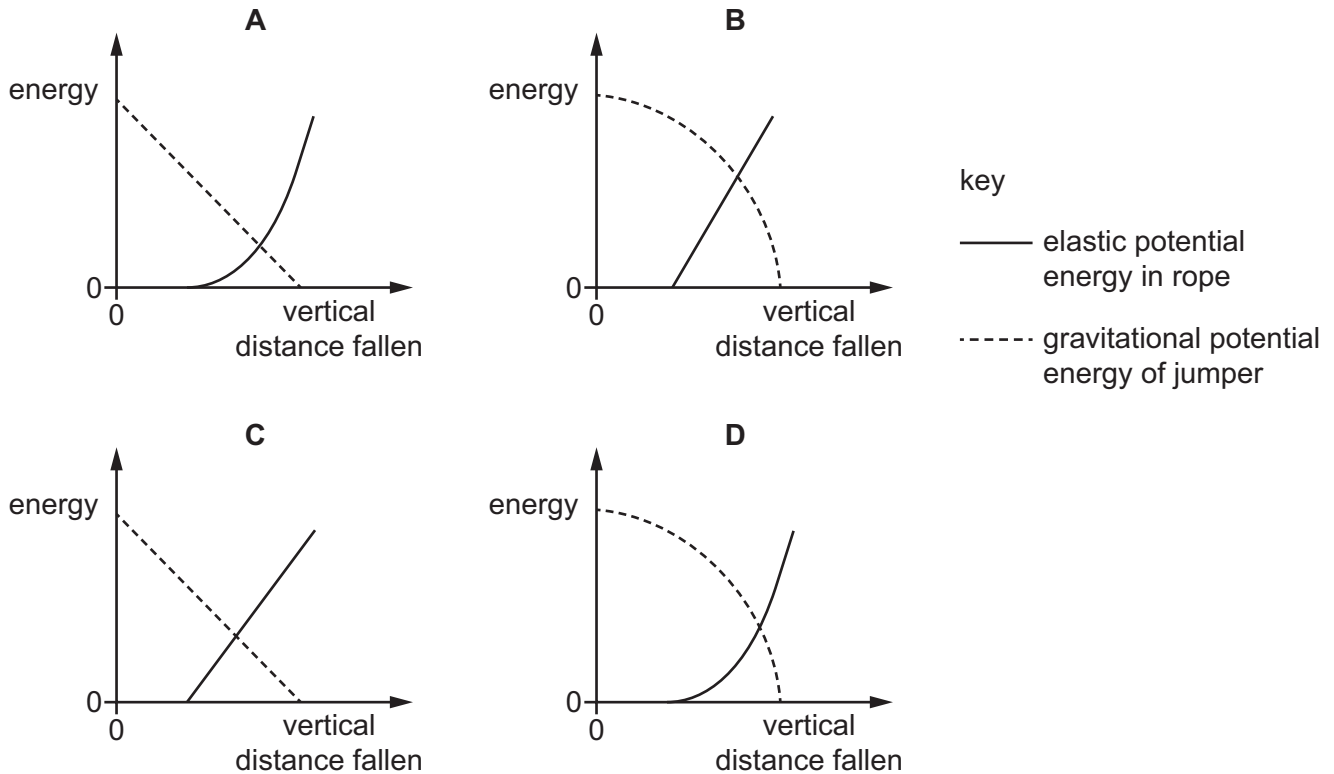

- 19 A train on a mountain railway is carrying 200 people of average mass 70 kg up a slope at an angle of  $30^\circ$  to the horizontal and at a speed of  $6.0 \text{ m s}^{-1}$ . The train itself has a mass of 80 000 kg. The percentage of the power from the engine which is used to raise the passengers and the train is 40%.

What is the power of the engine?

- A 1.1 MW      B 2.8 MW      C 6.9 MW      D 14 MW
- 20 A wire X is stretched by a force and gains elastic potential energy  $E$ .

The same force is applied to wire Y of the same material, with the same initial length but twice the diameter of wire X. Both wires obey Hooke's law.

What is the gain in elastic potential energy of wire Y?

- A  $0.25E$       B  $0.5E$       C  $2E$       D  $4E$

21 The diagram shows the arrangement of atoms in a particular crystal.

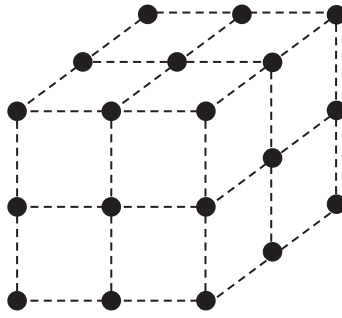

Each atom is at the corner of a cube.

The mass of each atom is  $3.5 \times 10^{-25}$  kg. The density of the crystal is  $9.2 \times 10^3$  kg m<sup>-3</sup>.

What is the shortest distance between the centres of two adjacent atoms?

- A  $3.8 \times 10^{-29}$  m
- B  $6.2 \times 10^{-15}$  m
- C  $3.4 \times 10^{-10}$  m
- D  $3.0 \times 10^{-9}$  m

22 The stress-strain graphs for loading and unloading four different materials are shown.

Which material exhibits purely elastic behaviour?

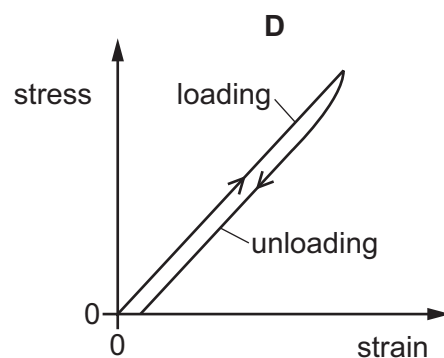
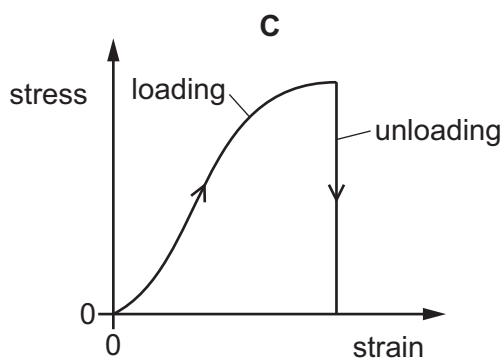
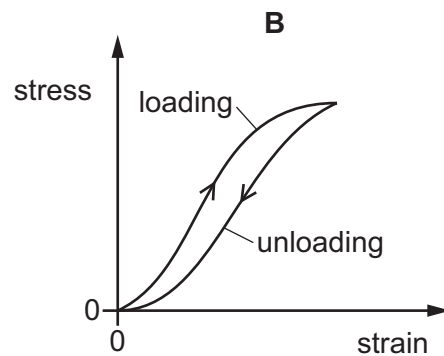
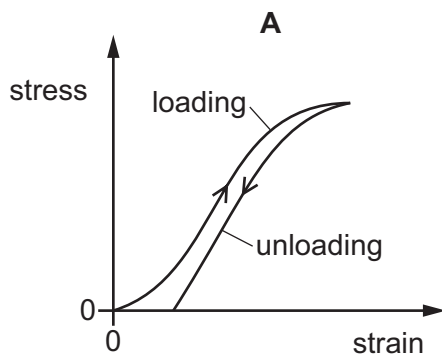

- 23 The diagram illustrates the position of particles in a progressive sound wave at one instant in time.

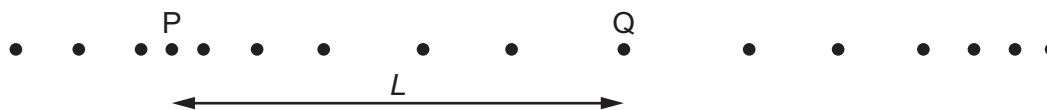

The speed of the wave is  $v$ . P and Q are two points in the wave a distance  $L$  apart.

What is an expression for the frequency of the wave?

A  $\frac{v}{2L}$

B  $\frac{v}{L}$

C  $\frac{2v}{L}$

D  $\frac{L}{v}$

- 24 A wave moves along the surface of water.

The diagram shows the variation of displacement  $s$  with distance along the wave at time  $t = 0$ .

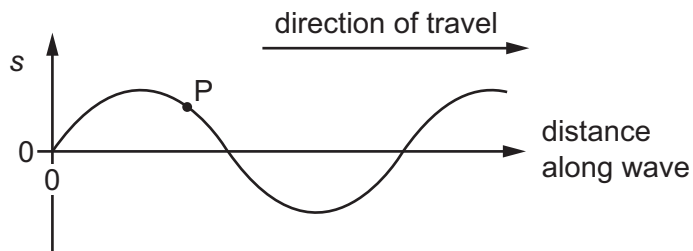

Which graph best shows the variation with time  $t$  of the displacement  $s$  of the point P on the wave?

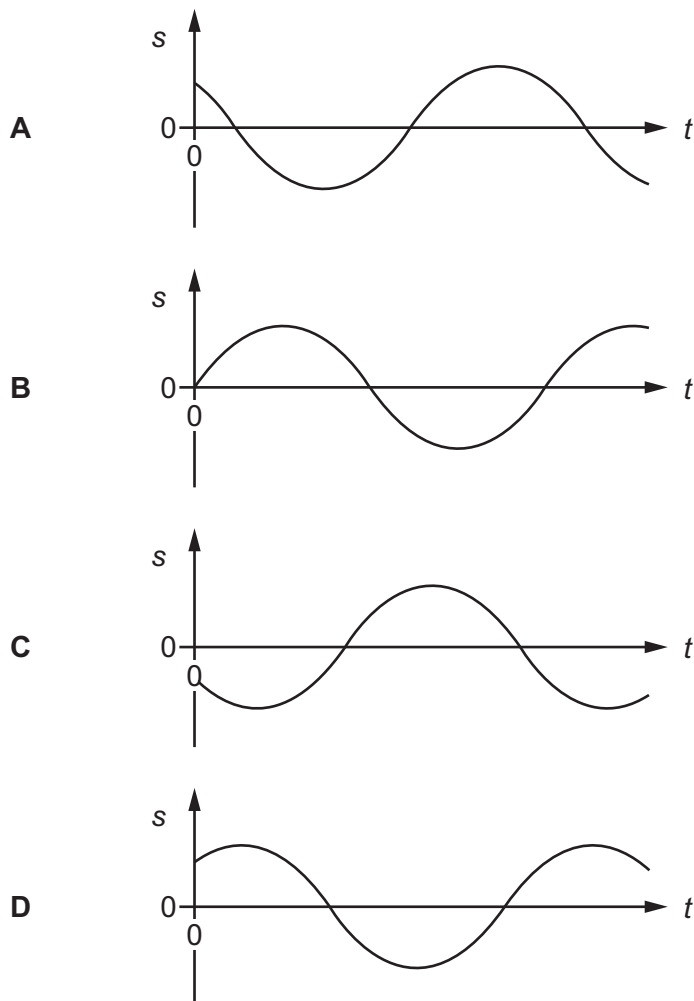

- 25 In an experiment to determine the wavelength of sound in air, a stationary wave is set up in an air column.

The distance between a node and an adjacent antinode is  $L$ .

What is the wavelength of the sound?

- A**  $\frac{1}{2}L$       **B**  $L$       **C**  $2L$       **D**  $4L$

- 26 In one of the first experiments to demonstrate the Doppler effect, a train was filled with trumpeters all playing a note of frequency 440 Hz. The difference in observed frequency of the note as the train directly approached a stationary observer was 22 Hz. The speed of sound was  $340 \text{ m s}^{-1}$ .

At which speed was the train moving?

- A  $15.4 \text{ m s}^{-1}$       B  $16.2 \text{ m s}^{-1}$       C  $17.0 \text{ m s}^{-1}$       D  $17.9 \text{ m s}^{-1}$

- 27 The electromagnetic spectrum consists of waves with different wavelengths.

Which row correctly identifies regions of the electromagnetic spectrum?

	$10^{-10} \text{ m}$	$10^{-8} \text{ m}$	$10^{-5} \text{ m}$	$10^{-2} \text{ m}$
<b>A</b>	microwaves	X-rays	ultraviolet	infrared
<b>B</b>	infrared	microwaves	X-rays	ultraviolet
<b>C</b>	microwaves	infrared	ultraviolet	X-rays
<b>D</b>	X-rays	ultraviolet	infrared	microwaves

- 28 A cathode-ray oscilloscope (CRO) is used to display the trace from a sound wave. The time-base is set at  $5 \mu\text{s mm}^{-1}$ .

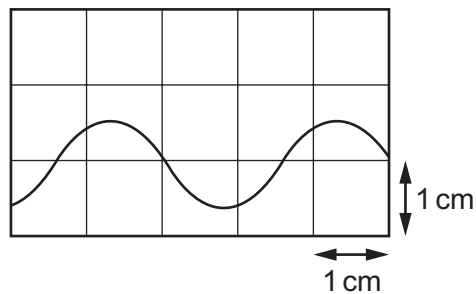

What is the frequency of the sound wave?

- A 6.7 Hz      B 67 Hz      C 6.7 kHz      D 67 kHz

29 Monochromatic light is directed at a diffraction grating, as shown.

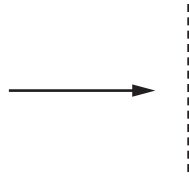

Which diagram could show all the possible directions of the light, after passing through the grating, that give maximum intensity?

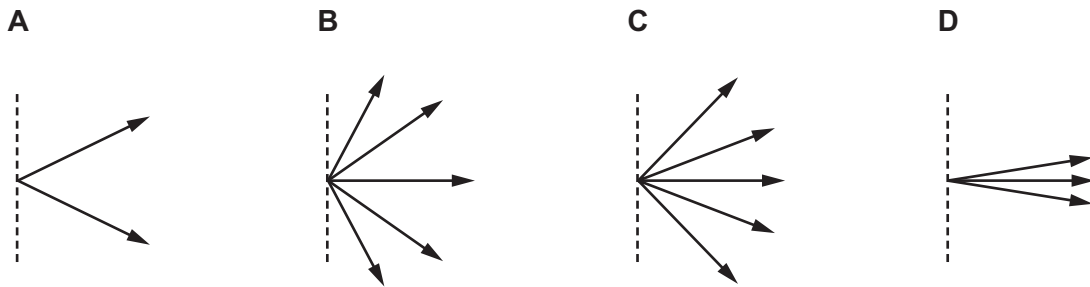

30 Why can an observable interference pattern **never** be obtained between two monochromatic beams of light from different lamps?

- A The frequency of the light from the two lamps can never be the same.
- B The light from the two lamps can never be coherent.
- C The temperature of the filaments of the two lamps used can never be the same.
- D The wavelength of the light from the two lamps must always be different.



- 31 A student sets up apparatus to observe the double-slit interference of monochromatic light, as shown.

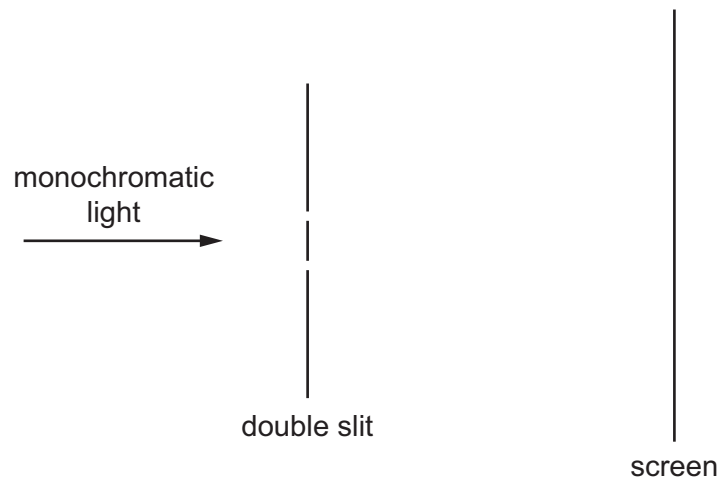

Interference fringes are formed on the screen.

Which change would increase the distance between adjacent fringes?

- A Decrease the distance between the two slits.
  - B Decrease the width of each slit.
  - C Move the screen closer to the double slit.
  - D Use light of a higher frequency.
- 32 An electron is situated in a vacuum between two charged plates, as shown.

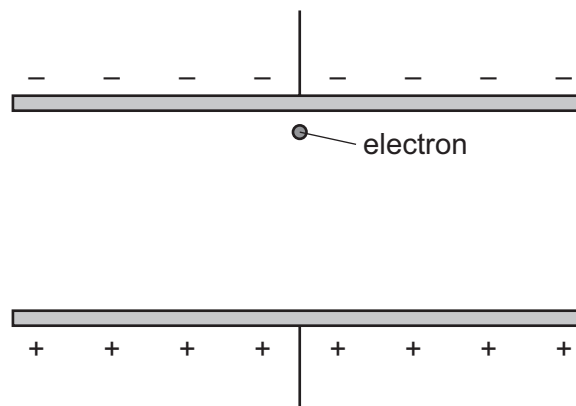

Which statement describes the motion of the electron due to the uniform electric field?

- A It moves downwards with a constant acceleration.
- B It moves downwards with zero acceleration.
- C It moves upwards with a constant acceleration.
- D It moves upwards with a decreasing acceleration.

- 33 A length of wire is connected into a circuit.

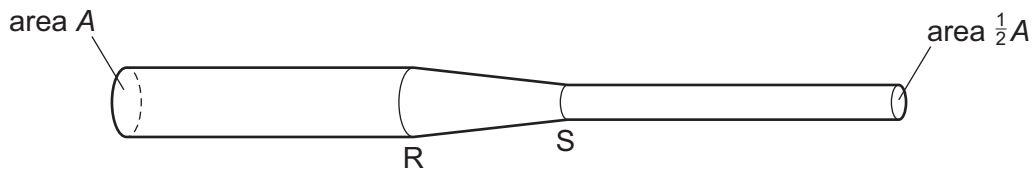

The area of the cross-section of the wire changes from  $A$  at  $R$  to  $\frac{1}{2}A$  at  $S$ .

There is a constant current in the wire. Charge  $Q$  passes  $R$  in time  $t$ .

What is the charge passing point  $S$  in the same time  $t$ ?

- A  $\frac{1}{2}Q$                       B  $Q$                       C  $Q\sqrt{2}$                       D  $2Q$
- 34 Four wires are made of the same metal. The cross-sectional areas, lengths and thermodynamic temperatures of the wires are shown.

Which wire has the largest resistance?

	cross-sectional area	length	temperature
<b>A</b>	$A$	$2L$	$2T$
<b>B</b>	$A$	$L$	$T$
<b>C</b>	$2A$	$2L$	$2T$
<b>D</b>	$2A$	$L$	$T$

35 A cell with internal resistance is connected to a variable resistor  $R$  as shown.

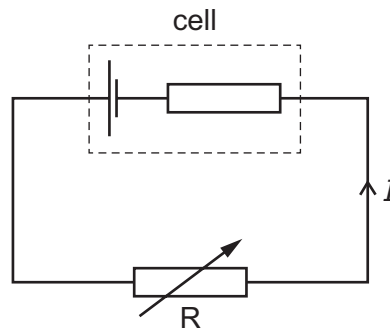

The resistance of  $R$  is gradually decreased.

How do the current  $I$  and the terminal potential difference across the cell change?

	current $I$	terminal potential difference across cell
<b>A</b>	decreases	decreases
<b>B</b>	decreases	increases
<b>C</b>	increases	decreases
<b>D</b>	increases	increases

36 Kirchhoff's first law states that the sum of the currents entering a junction in a circuit is equal to the sum of the currents leaving it.

The law is based on the conservation of a physical quantity.

What is this physical quantity?

- A** charge
- B** energy
- C** mass
- D** momentum

- 37 A circuit contains two batteries, each of negligible internal resistance, and two resistors as shown.

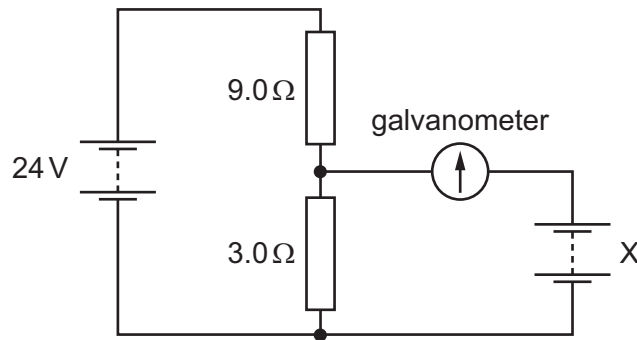

The galvanometer has a current reading of zero.

What is the electromotive force (e.m.f.) of battery X?

- A** 6.0V                      **B** 8.0V                      **C** 16.0V                      **D** 18.0V
- 38 A nucleus of francium-221 ( ${}_{87}^{221}\text{Fr}$ ) decays into a nucleus of bismuth-209 ( ${}_{83}^{209}\text{Bi}$ ) in several steps.

Which particles could be emitted?

- A** 2  $\alpha$ -particles and 4  $\beta^-$  particles  
**B** 2  $\alpha$ -particles and 4  $\beta^+$  particles  
**C** 3  $\alpha$ -particles and 2  $\beta^-$  particles  
**D** 3  $\alpha$ -particles and 2  $\beta^+$  particles
- 39 Which equation describes the changes to the quark composition of a nucleus and the lepton emission during the process of  $\beta^+$  decay?
- A** down  $\rightarrow$  up + positron + electron neutrino  
**B** down  $\rightarrow$  up + positron + electron antineutrino  
**C** up  $\rightarrow$  down + positron + electron neutrino  
**D** up  $\rightarrow$  down + positron + electron antineutrino
- 40 There are protons, neutrons and electrons in the simple model of an atom.

To which class (group), hadron or lepton, do these particles belong?

	hadron	lepton
<b>A</b>	electron	proton and neutron
<b>B</b>	neutron	proton and electron
<b>C</b>	proton and electron	neutron
<b>D</b>	proton and neutron	electron

**BLANK PAGE**

**BLANK PAGE**

**BLANK PAGE**

**BLANK PAGE**

---

Permission to reproduce items where third-party owned material protected by copyright is included has been sought and cleared where possible. Every reasonable effort has been made by the publisher (UCLES) to trace copyright holders, but if any items requiring clearance have unwittingly been included, the publisher will be pleased to make amends at the earliest possible opportunity.

To avoid the issue of disclosure of answer-related information to candidates, all copyright acknowledgements are reproduced online in the Cambridge Assessment International Education Copyright Acknowledgements Booklet. This is produced for each series of examinations and is freely available to download at [www.cambridgeinternational.org](http://www.cambridgeinternational.org) after the live examination series.

Cambridge Assessment International Education is part of the Cambridge Assessment Group. Cambridge Assessment is the brand name of the University of Cambridge Local Examinations Syndicate (UCLES), which itself is a department of the University of Cambridge.