

---

**PHYSICS**

**9702/12**

Paper 1 Multiple Choice

**May/June 2018**

**1 hour 15 minutes**

Additional Materials:      Multiple Choice Answer Sheet  
   Soft clean eraser  
   Soft pencil (type B or HB is recommended)

\*  
4  
4  
7  
9  
2  
8  
6  
6  
9  
4  
9  
\*

---

**READ THESE INSTRUCTIONS FIRST**

Write in soft pencil.

Do not use staples, paper clips, glue or correction fluid.

Write your name, Centre number and candidate number on the Answer Sheet in the spaces provided unless this has been done for you.

**DO NOT WRITE IN ANY BARCODES.**

There are **forty** questions on this paper. Answer **all** questions. For each question there are four possible answers **A, B, C** and **D**.

Choose the **one** you consider correct and record your choice in **soft pencil** on the separate Answer Sheet.

**Read the instructions on the Answer Sheet very carefully.**

Each correct answer will score one mark. A mark will not be deducted for a wrong answer.

Any working should be done in this booklet.

Electronic calculators may be used.

---

This document consists of **20** printed pages.

**Data**

speed of light in free space	$c = 3.00 \times 10^8 \text{ m s}^{-1}$
permeability of free space	$\mu_0 = 4\pi \times 10^{-7} \text{ H m}^{-1}$
permittivity of free space	$\epsilon_0 = 8.85 \times 10^{-12} \text{ F m}^{-1}$ $(\frac{1}{4\pi\epsilon_0} = 8.99 \times 10^9 \text{ m F}^{-1})$
elementary charge	$e = 1.60 \times 10^{-19} \text{ C}$
the Planck constant	$h = 6.63 \times 10^{-34} \text{ J s}$
unified atomic mass unit	$1 \text{ u} = 1.66 \times 10^{-27} \text{ kg}$
rest mass of electron	$m_e = 9.11 \times 10^{-31} \text{ kg}$
rest mass of proton	$m_p = 1.67 \times 10^{-27} \text{ kg}$
molar gas constant	$R = 8.31 \text{ J K}^{-1} \text{ mol}^{-1}$
the Avogadro constant	$N_A = 6.02 \times 10^{23} \text{ mol}^{-1}$
the Boltzmann constant	$k = 1.38 \times 10^{-23} \text{ J K}^{-1}$
gravitational constant	$G = 6.67 \times 10^{-11} \text{ N m}^2 \text{ kg}^{-2}$
acceleration of free fall	$g = 9.81 \text{ m s}^{-2}$

**Formulae**

uniformly accelerated motion	$s = ut + \frac{1}{2}at^2$ $v^2 = u^2 + 2as$
work done on/by a gas	$W = p\Delta V$
gravitational potential	$\phi = -\frac{Gm}{r}$
hydrostatic pressure	$p = \rho gh$
pressure of an ideal gas	$p = \frac{1}{3}\frac{Nm}{V}\langle c^2 \rangle$
simple harmonic motion	$a = -\omega^2 x$
velocity of particle in s.h.m.	$v = v_0 \cos \omega t$ $v = \pm \omega \sqrt{(x_0^2 - x^2)}$
Doppler effect	$f_o = \frac{f_s v}{v \pm v_s}$
electric potential	$V = \frac{Q}{4\pi\epsilon_0 r}$
capacitors in series	$1/C = 1/C_1 + 1/C_2 + \dots$
capacitors in parallel	$C = C_1 + C_2 + \dots$
energy of charged capacitor	$W = \frac{1}{2}QV$
electric current	$I = Anvq$
resistors in series	$R = R_1 + R_2 + \dots$
resistors in parallel	$1/R = 1/R_1 + 1/R_2 + \dots$
Hall voltage	$V_H = \frac{BI}{ntq}$
alternating current/voltage	$x = x_0 \sin \omega t$
radioactive decay	$x = x_0 \exp(-\lambda t)$
decay constant	$\lambda = \frac{0.693}{t_{\frac{1}{2}}}$

- 1 A sheet of gold leaf has a thickness of  $0.125\ \mu\text{m}$ . A gold atom has a radius of  $174\ \text{pm}$ .

Approximately how many layers of atoms are there in the sheet?

- A 4                      B 7                      C 400                      D 700

- 2 The drag coefficient  $C_d$  is a number with no units. It is used to compare the drag on different cars at different speeds.  $C_d$  is given by the equation

$$C_d = \frac{2F}{v^n \rho A}$$

where  $F$  is the drag force on the car,  $\rho$  is the density of the air,  $A$  is the cross-sectional area of the car and  $v$  is the speed of the car.

What is the value of  $n$ ?

- A 1                      B 2                      C 3                      D 4

- 3 A student measures the current through a resistor and the potential difference (p.d.) across it. There is a 4% uncertainty in the current reading and a 1% uncertainty in the p.d. reading. The student calculates the resistance of the resistor.

What is the percentage uncertainty in the calculated resistance?

- A 0.25%                      B 3%                      C 4%                      D 5%

- 4 A student applies a potential difference  $V$  of  $(4.0 \pm 0.1)\text{V}$  across a resistor of resistance  $R$  of  $(10.0 \pm 0.3)\ \Omega$  for a time  $t$  of  $(50 \pm 1)\text{s}$ .

The student calculates the energy  $E$  dissipated using the equation below.

$$E = \frac{V^2 t}{R} = \frac{4.0^2 \times 50}{10.0} = 80\ \text{J}$$

What is the absolute uncertainty in the calculated energy value?

- A 1.5 J                      B 3 J                      C 6 J                      D 8 J

5 The velocity of an object changes with time  $t$  as shown.

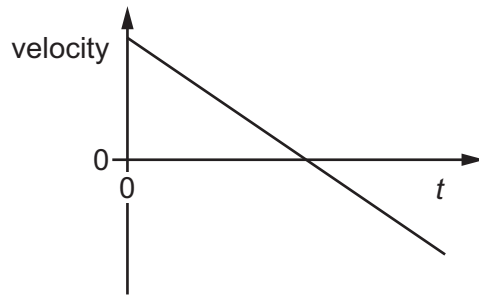

Which graph best shows the variation with time  $t$  of the displacement  $s$  of the object?

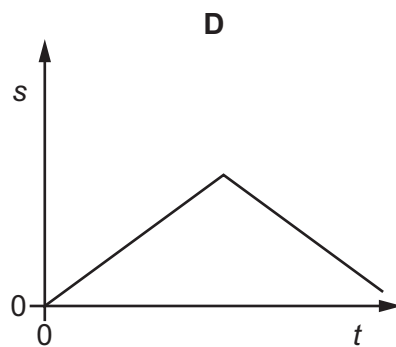
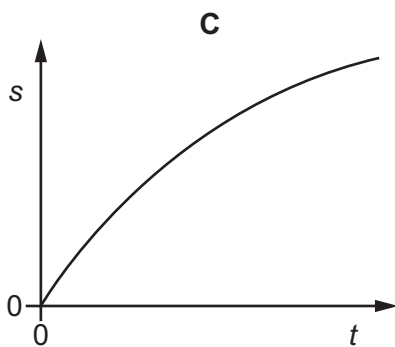
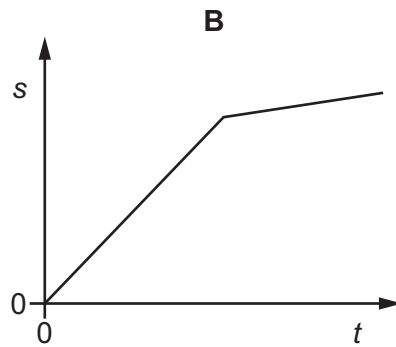
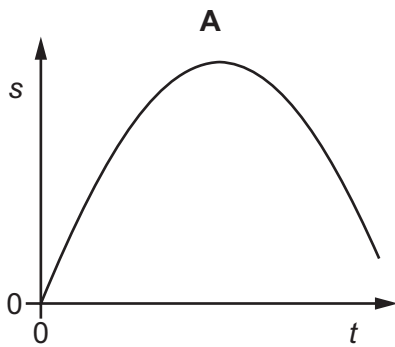

- 6 A projectile is launched at an angle to the horizontal at time  $t = 0$ . It travels over horizontal ground, as shown.

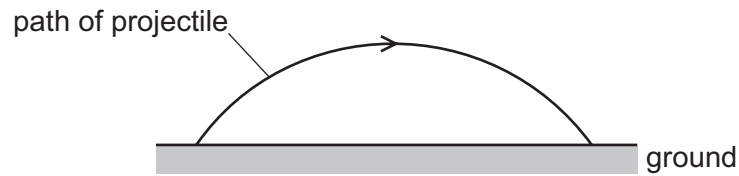

Assume that air resistance is negligible.

Which graph best shows the variation with  $t$  of the speed of the projectile from when it is launched to when it lands on the ground?

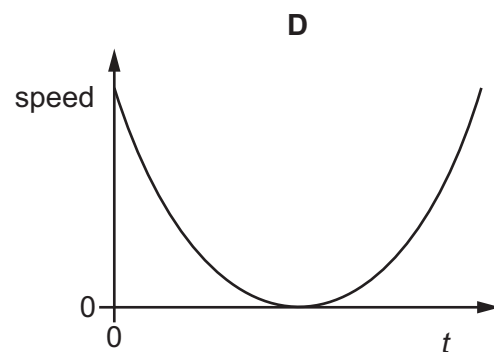
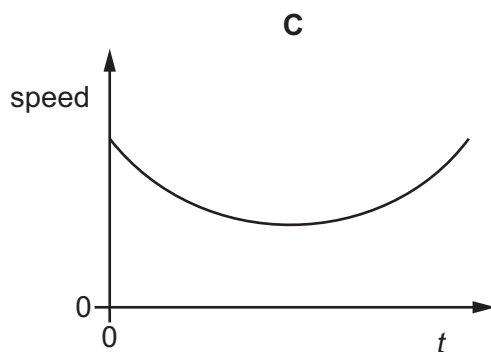
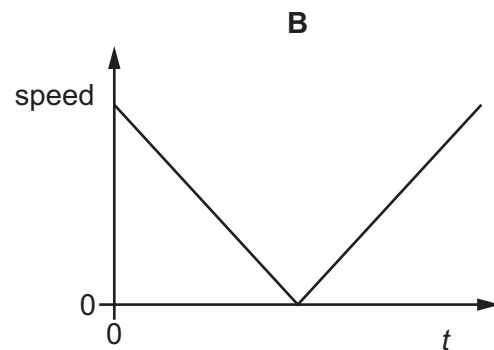
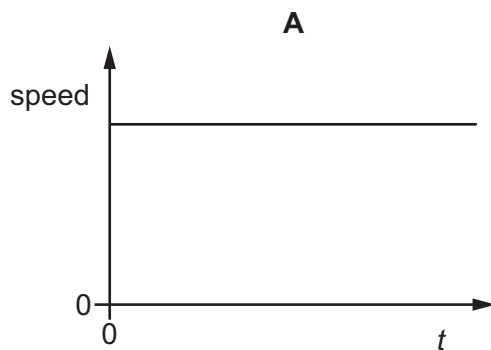



- 10 The density of water is  $1.0 \text{ g cm}^{-3}$  and the density of glycerine is  $1.3 \text{ g cm}^{-3}$ .

Water is added to a measuring cylinder containing  $40 \text{ cm}^3$  of glycerine so that the density of the mixture is  $1.1 \text{ g cm}^{-3}$ . Assume that the mixing process does not change the total volume of the liquid.

What is the volume of water added?

- A  $40 \text{ cm}^3$       B  $44 \text{ cm}^3$       C  $52 \text{ cm}^3$       D  $80 \text{ cm}^3$
- 11 An astronaut throws a stone horizontally near to the surface of the Moon, where there is no atmosphere.

Which row describes the horizontal and vertical forces acting on the stone after release?

	horizontal force	vertical force
<b>A</b>	non-zero and constant	constant
<b>B</b>	non-zero and constant	decreasing
<b>C</b>	zero	constant
<b>D</b>	zero	decreasing

- 12 A cylindrical block of wood has cross-sectional area  $A$  and weight  $W$ . It is totally immersed in water with its axis vertical. The block experiences pressures  $p_t$  and  $p_b$  at its top and bottom surfaces respectively.

Which expression is equal to the upthrust on the block?

- A  $(p_b - p_t)$   
 B  $(p_b - p_t)A$   
 C  $(p_b - p_t)A - W$   
 D  $(p_b - p_t)A + W$



- 13 A uniform diving-board is held by two fixed rods at points P and Q. A person stands at end R of the diving-board, as shown.

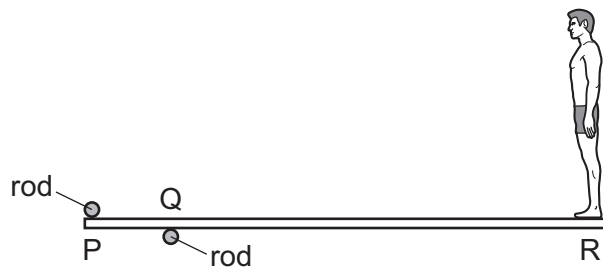

The forces exerted by the rods on the board are vertical. The board remains in equilibrium as the person slowly moves towards point Q from end R.

Which row describes the changes to the forces exerted by the rods on the board?

	force at P	force at Q
<b>A</b>	decreases	decreases
<b>B</b>	decreases	increases
<b>C</b>	increases	decreases
<b>D</b>	increases	increases

- 14 Two forces, each of magnitude  $F$ , act in opposite directions on a rod.

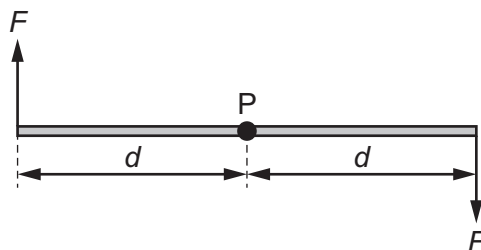

Each force acts on the rod at a distance  $d$  from the pivot P.

What is the torque of this couple about P?

- A** 0                      **B**  $F \times d$                       **C**  $2F \times d$                       **D**  $2F \times 2d$

- 15 The vector diagram shows three coplanar forces acting on an object at P.

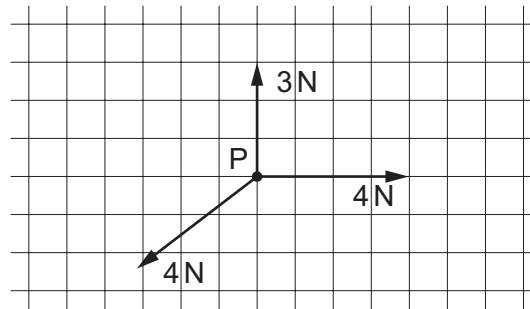

The magnitude of the resultant of these three forces is 1 N.

What is the direction of this resultant force?

- A       B       C       D 

- 16 In 'normal driving conditions', an electric car has a range of 150 km. This uses all of the 200 MJ of energy stored in its batteries.

With the batteries initially fully charged, the car is driven 100 km in 'normal driving conditions'. The batteries are then recharged from a household electrical supply delivering a constant current of 13.0 A at a potential difference of 230 V.

What is the minimum time required to recharge the batteries?

- A 0.95 hours  
B 12.4 hours  
C 18.6 hours  
D 27.9 hours

- 17 The diagram shows a ball of weight  $W$  hanging in equilibrium from a string.

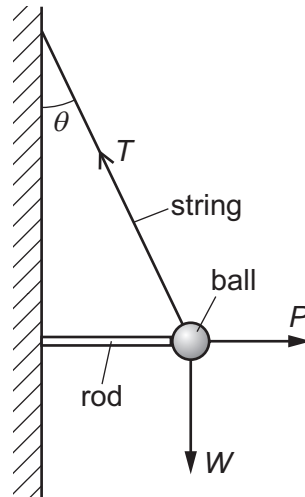

The string is at an angle  $\theta$  to the vertical. The tension in the string is  $T$ . The ball is held away from the wall by a horizontal force  $P$  from a metal rod.

What is the relationship between the magnitudes of  $T$ ,  $P$  and  $W$ ?

- A  $P = T \cos \theta$  and  $W = T \sin \theta$
- B  $T = P + W$
- C  $T^2 = P^2 + W^2$
- D  $W = P \tan \theta$  and  $W = T \cos \theta$
- 18 A steel sphere is dropped vertically onto a horizontal metal plate. The sphere hits the plate with speed  $u$ , leaves it at speed  $v$ , and rebounds vertically to half of its original height. Ignore air resistance.

Which expression gives the value of  $\frac{v}{u}$ ?

- A  $\frac{1}{2^2}$       B  $\frac{1}{2}$       C  $\frac{1}{\sqrt{2}}$       D  $1 - \frac{1}{\sqrt{2}}$

- 19 A car of mass 500 kg is at rest at point X on a slope, as shown.

The car's brakes are released and the car rolls down the slope with its engine switched off. At point Y the car has moved through a vertical height of 30 m and has a speed of  $11 \text{ m s}^{-1}$ .

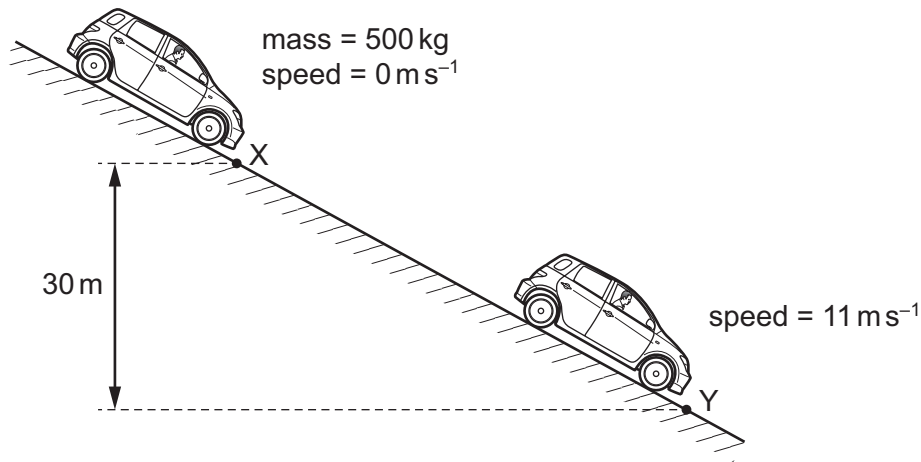

What is the energy dissipated by frictional forces when the car moves from X to Y?

- A  $3.0 \times 10^4 \text{ J}$     B  $1.2 \times 10^5 \text{ J}$     C  $1.5 \times 10^5 \text{ J}$     D  $1.8 \times 10^5 \text{ J}$
- 20 An elastic material with Young modulus  $E$  is subjected to a tensile stress  $S$ . Hooke's law is obeyed.

What is the expression for the elastic energy stored per unit volume of the material?

- A  $\frac{E}{2S^2}$     B  $\frac{2E}{S^2}$     C  $\frac{S^2}{E}$     D  $\frac{S^2}{2E}$

- 21 The graph shows the length of a spring as it is stretched by an increasing load.

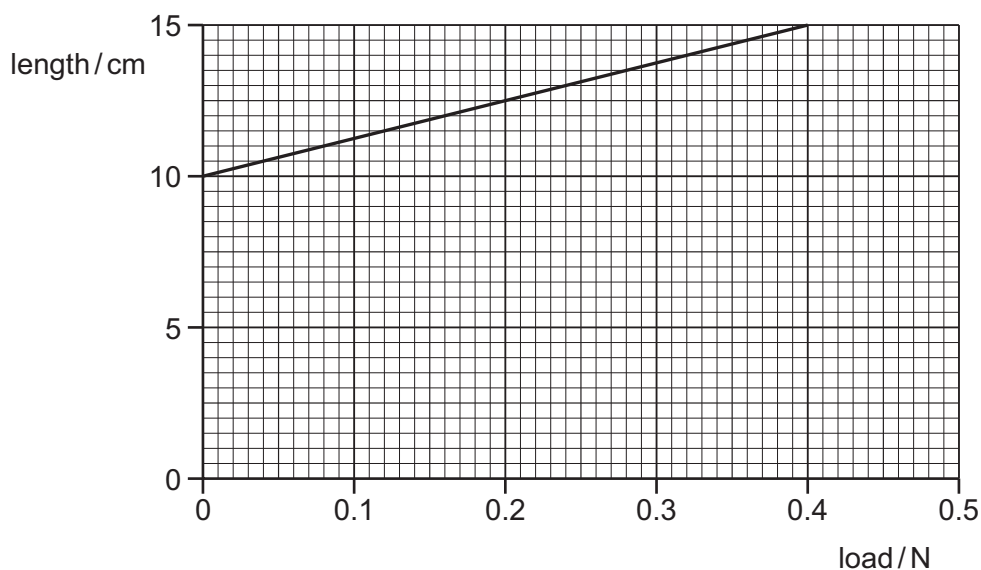

What is the spring constant of the spring?

- A  $0.080 \text{ N m}^{-1}$     B  $0.13 \text{ N m}^{-1}$     C  $2.7 \text{ N m}^{-1}$     D  $8.0 \text{ N m}^{-1}$

- 22 Two lasers emit light in a vacuum. One laser emits red light and the other emits green light.

Which property of the two laser beams **must** be different?

- A amplitude
- B frequency
- C intensity
- D speed

- 23 The diagram shows the screen of a cathode-ray oscilloscope (c.r.o.) displaying a wave.

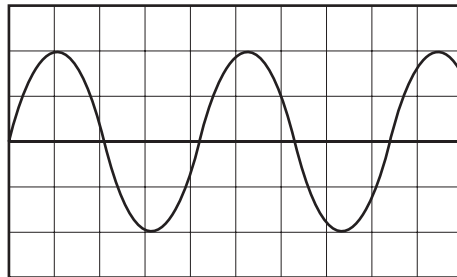

The time-base of the c.r.o. is set at 10 ms/division.

What is the frequency of the wave?

- A 0.24 Hz
  - B 4.2 Hz
  - C 12 Hz
  - D 24 Hz
- 24 A string is fixed at one end and the other end is attached to a vibrator. The frequency of the vibrator is slowly increased from zero. A series of stationary waves is formed. Assume that for a stationary wave there is a node at point P.

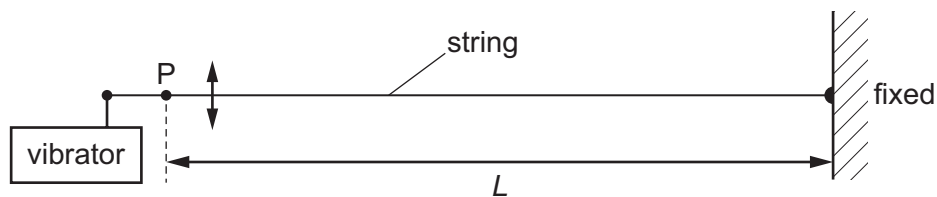

What are the first five wavelengths of the stationary waves that could be formed?

- A  $2\frac{L}{1}, 2\frac{L}{2}, 2\frac{L}{3}, 2\frac{L}{4}, 2\frac{L}{5}$
- B  $2\frac{L}{2}, 2\frac{L}{3}, 2\frac{L}{4}, 2\frac{L}{5}, 2\frac{L}{6}$
- C  $4\frac{L}{1}, 4\frac{L}{2}, 4\frac{L}{3}, 4\frac{L}{4}, 4\frac{L}{5}$
- D  $4\frac{L}{1}, 4\frac{L}{3}, 4\frac{L}{5}, 4\frac{L}{7}, 4\frac{L}{9}$

- 25 Which region of the electromagnetic spectrum has waves of wavelength 1000 times smaller than the wavelength of visible light?
- A infra-red  
B microwaves  
C ultraviolet  
D X-rays
- 26 The diagram shows apparatus for the measurement of the frequency of a sound wave.



Sound of the unknown frequency is reflected back from a metal plate. A microphone placed at a distance  $D$  from the metal plate detects the sound intensity. A minimum intensity is detected with  $D = 12.0$  cm. The plate is moved further away from the microphone until the next minimum is detected with  $D = 15.0$  cm.

The speed of sound in air is  $336 \text{ m s}^{-1}$ .

What is the frequency of the sound?

- A 56 Hz            B 112 Hz            C 5600 Hz            D 11 200 Hz
- 27 An astronomer observes the light from a star that is moving away from the Earth.
- For the observed light, what has been increased due to the star's motion?
- A amplitude  
B frequency  
C speed  
D wavelength

- 28 The diagram shows a stationary wave, at time  $t = 0$ , that has been set up on a string fixed between points P and S.

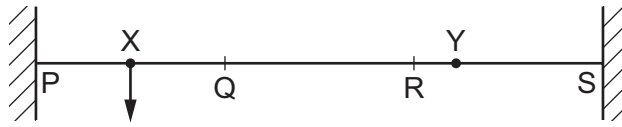

The nodes of the stationary wave occur on the string at P, Q, R and S. Point X is moving down at time  $t = 0$ . The points on the string vibrate with time period  $T$  and maximum amplitude 2 cm.

The displacement  $s$  is positive in the upward direction.

Which graph best shows the variation with  $t$  of the displacement  $s$  of point Y on the string?

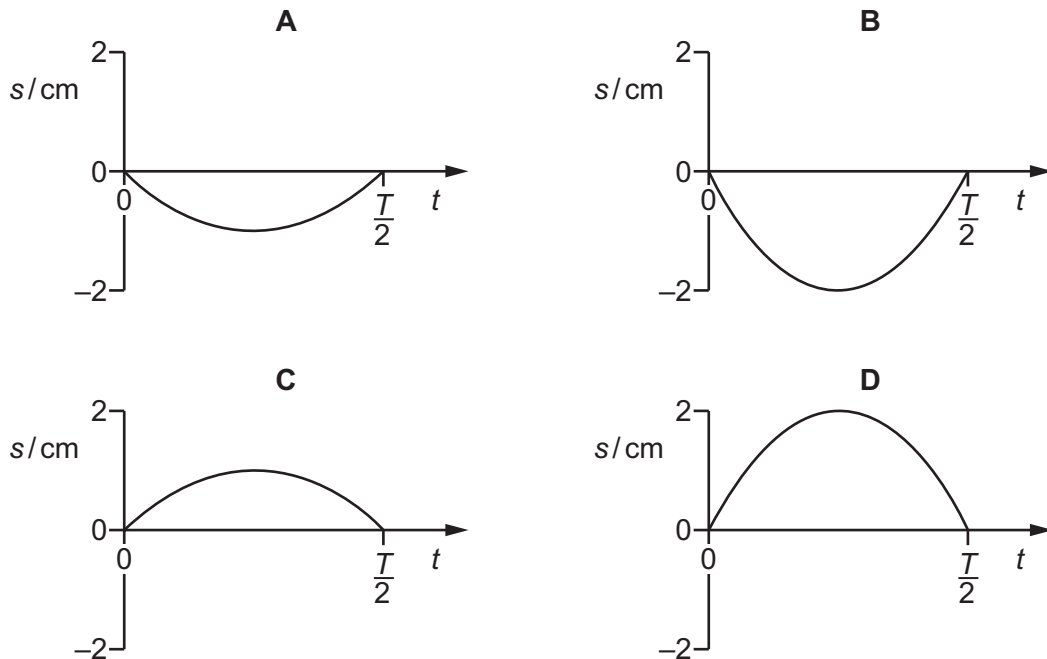

- 29 A two-source interference experiment uses the apparatus shown.

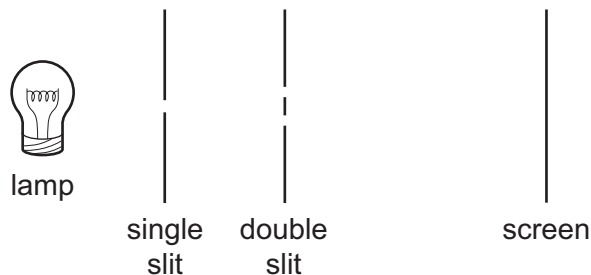

What is the main purpose of the single slit?

- A to make a narrow beam of light
- B to make the same amplitude of light incident on each slit
- C to provide coherent light
- D to provide monochromatic light

- 30 Two large parallel metal plates X and Y are situated in a vacuum as shown.

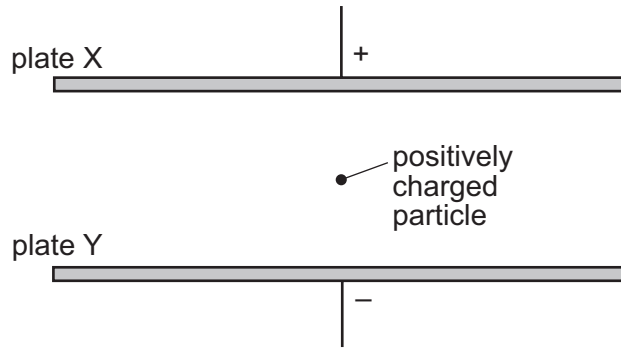

Plates X and Y carry equal and opposite charges.

What happens to the force on a positively charged particle as it moves from plate X to plate Y?

- A** It decreases because the positively charged particle is moving away from the positively charged plate.
- B** It decreases because the positively charged particle is moving in the direction of the electric field between the plates.
- C** It increases because the positively charged particle is moving closer to a negatively charged plate.
- D** It remains constant because the positively charged particle is in the uniform electric field between the plates.
- 31 Four diagrams representing the electric field between two oppositely-charged point charges are shown.

Which diagram correctly shows the electric field lines?

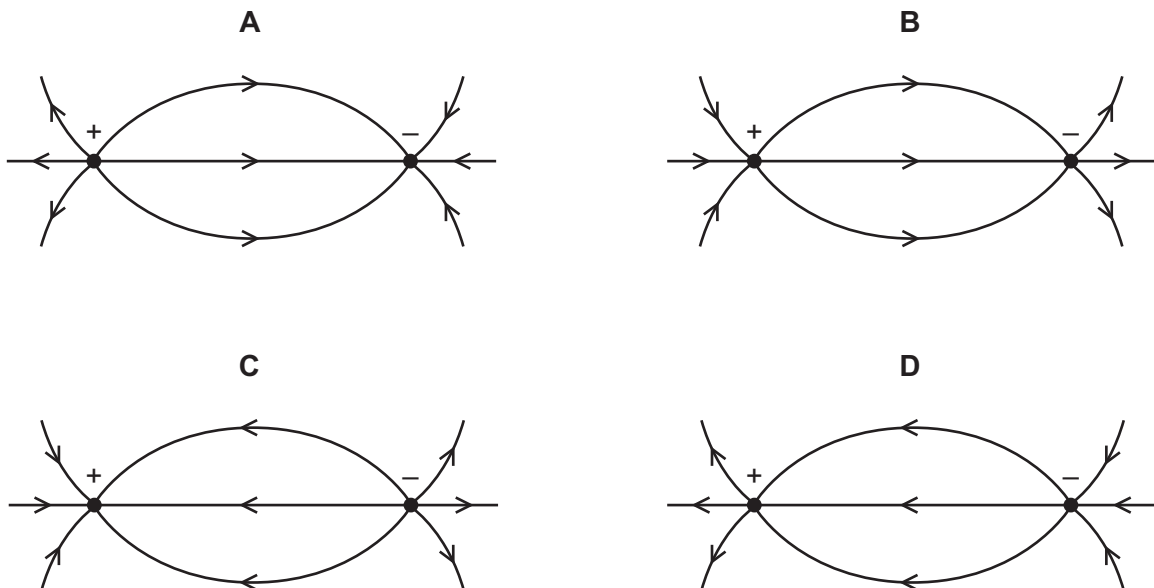



- 32 The power output of an electrical supply is 2.4 kW at a potential difference (p.d.) of 240 V. The two wires between the supply and a kettle each have a resistance of  $0.50 \Omega$ , as shown.

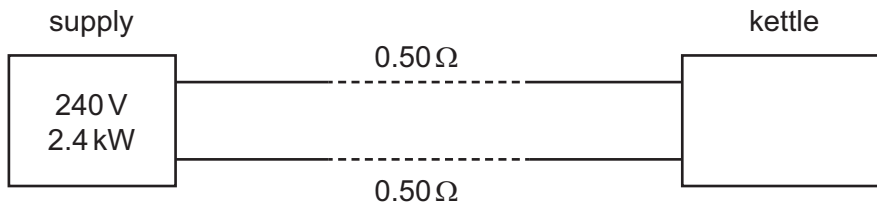

What is the power supplied to the kettle and what is the p.d. across the kettle?

	power/kW	p.d./V
<b>A</b>	2.3	230
<b>B</b>	2.3	235
<b>C</b>	2.4	230
<b>D</b>	2.4	235

- 33 Which graph shows the variation of voltage  $V$  with current  $I$  for a semiconductor diode?

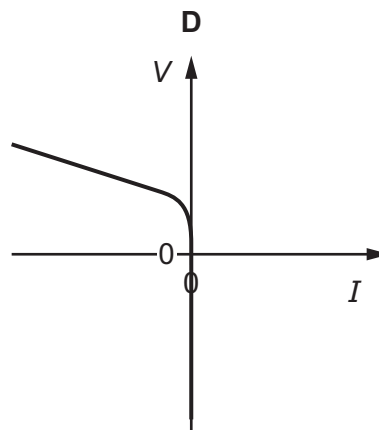
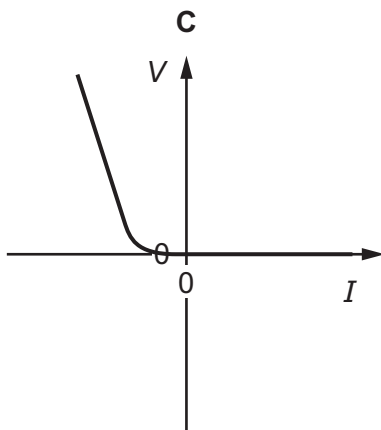
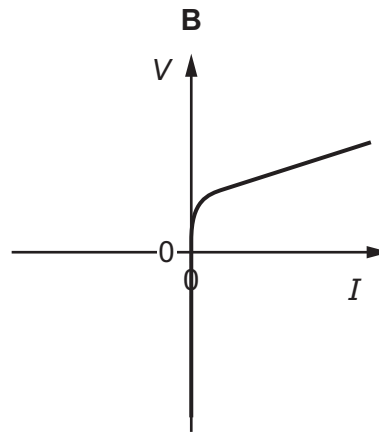
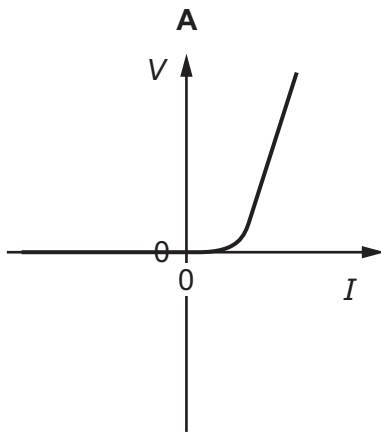

34 Four different resistors are arranged as shown.

A current of 1.5 A enters the network at junction X and leaves through junction Y.

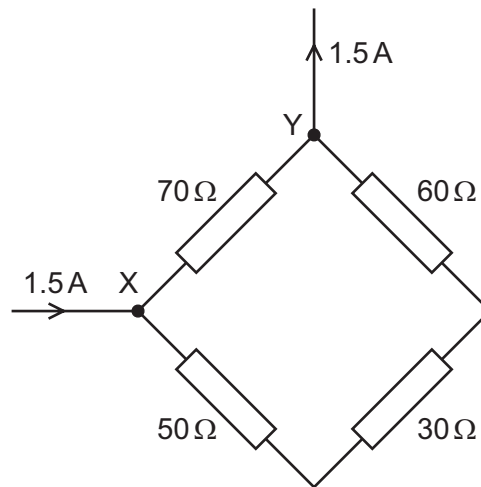

What is the current in the resistor of resistance  $30\ \Omega$ ?

- A** 0.21 A      **B** 0.50 A      **C** 0.75 A      **D** 1.0 A

35 A cell of constant electromotive force drives a current  $I$  through an external resistor of resistance  $R$ . The terminal potential difference (p.d.) across the cell is  $V$ .

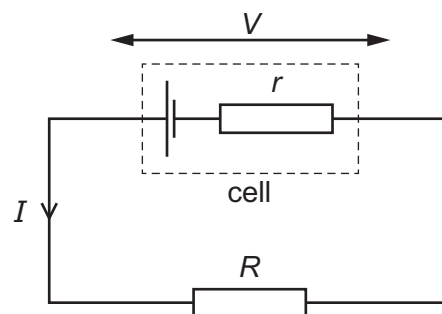

When the internal resistance  $r$  of the cell increases, what is the effect on  $V$  and on  $I$ ?

	$V$	$I$
<b>A</b>	decreases	decreases
<b>B</b>	decreases	increases
<b>C</b>	increases	decreases
<b>D</b>	increases	increases

- 36** In the circuits shown, the batteries are identical and all have negligible internal resistance. All of the resistors have the same resistance. The diodes have zero resistance when conducting and infinite resistance when not conducting.

In which circuit is the current in the battery greatest?

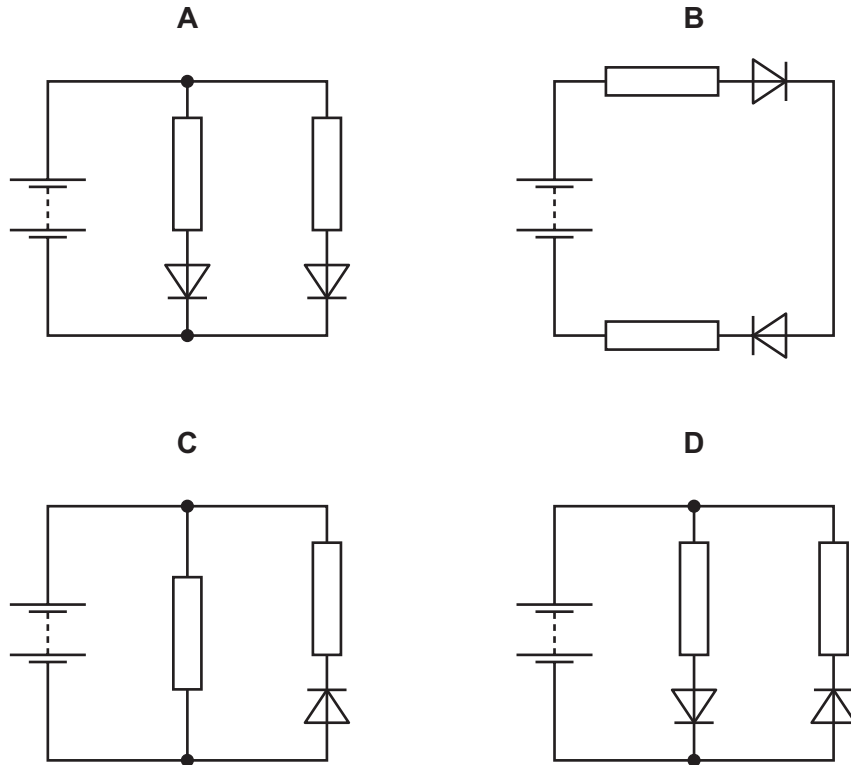

- 37** A thermistor is an electrical component with a resistance that varies with temperature. A thermistor T is used in a fire alarm system. The alarm is triggered when the potential difference between X and Y is 4.5 V.

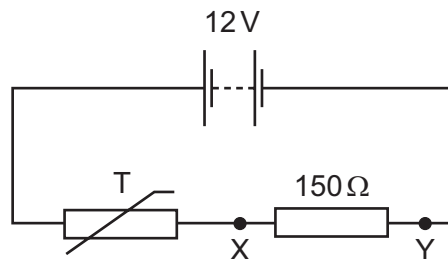

What is the resistance of T when the alarm is triggered?

- A**  $90\ \Omega$       **B**  $150\ \Omega$       **C**  $250\ \Omega$       **D**  $400\ \Omega$

- 38 In the  $\alpha$ -particle scattering experiment, a beam of  $\alpha$ -particles is aimed at a thin gold foil. Most of the  $\alpha$ -particles go straight through or are deflected by a small angle. A very small proportion are deflected through more than  $90^\circ$ , effectively rebounding towards the source of the  $\alpha$ -particles.

Which conclusion about the structure of atoms **cannot** be drawn from this experiment alone?

- A Most of the atom is empty space.  
 B Most of the mass of an atom is concentrated in the nucleus.  
 C The nucleus contains both protons and neutrons.  
 D The nucleus is charged.
- 39 Radon-211,  ${}_{86}^{211}\text{Rn}$ , francium-210,  ${}_{87}^{210}\text{Fr}$ , and radium-212,  ${}_{88}^{212}\text{Ra}$ , are three nuclides.

How many neutrons does each nuclide have in its nucleus?

	radon-211	francium-210	radium-212
A	86	87	88
B	125	123	124
C	211	210	212
D	297	297	300

- 40 A neutron is composed of one up (u) quark and two down (d) quarks. When the neutron decays to a proton, there is  $\beta$ -emission.

What is the change in the quark structure of the neutron due to the  $\beta$ -emission?

(The symbol for a neutrino is  $\nu_e$  and for an antineutrino is  $\bar{\nu}_e$ .)

- A  $d \rightarrow u + \beta^- + \nu_e$   
 B  $d \rightarrow u + \beta^- + \bar{\nu}_e$   
 C  $u \rightarrow d + \beta^+ + \nu_e$   
 D  $u \rightarrow d + \beta^+ + \bar{\nu}_e$

---

Permission to reproduce items where third-party owned material protected by copyright is included has been sought and cleared where possible. Every reasonable effort has been made by the publisher (UCLES) to trace copyright holders, but if any items requiring clearance have unwittingly been included, the publisher will be pleased to make amends at the earliest possible opportunity.

To avoid the issue of disclosure of answer-related information to candidates, all copyright acknowledgements are reproduced online in the Cambridge International Examinations Copyright Acknowledgements Booklet. This is produced for each series of examinations and is freely available to download at [www.cie.org.uk](http://www.cie.org.uk) after the live examination series.

Cambridge International Examinations is part of the Cambridge Assessment Group. Cambridge Assessment is the brand name of University of Cambridge Local Examinations Syndicate (UCLES), which is itself a department of the University of Cambridge.