



Cambridge
O Level

Cambridge International Examinations
Cambridge Ordinary Level

BIOLOGY

5090/12

Paper 1 Multiple Choice

October/November 2016

1 hour

Additional Materials: Multiple Choice Answer Sheet
Soft clean eraser
Soft pencil (type B or HB is recommended)

*
6
5
8
7
8
2
6
2
3
0
*



READ THESE INSTRUCTIONS FIRST

Write in soft pencil.

Do not use staples, paper clips, glue or correction fluid.

Write your name, Centre number and candidate number on the Answer Sheet in the spaces provided unless this has been done for you.

DO NOT WRITE IN ANY BARCODES.

There are **forty** questions on this paper. Answer **all** questions. For each question there are four possible answers **A, B, C** and **D**.

Choose the **one** you consider correct and record your choice in **soft pencil** on the separate Answer Sheet.

Read the instructions on the Answer Sheet very carefully.

Each correct answer will score one mark. A mark will not be deducted for a wrong answer.

Any rough working should be done in this booklet.

Electronic calculators may be used.

This document consists of **22** printed pages and **2** blank pages.

2

1 The diagram shows a plant cell.

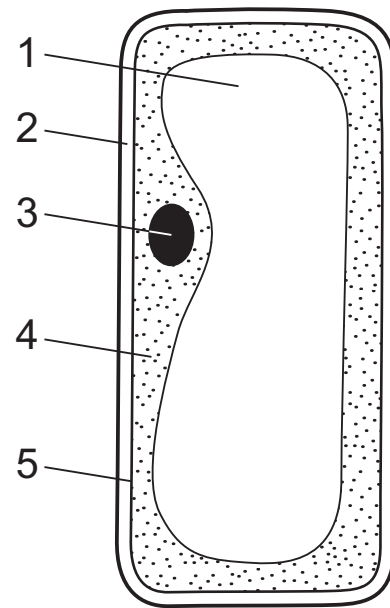

Which two structures are **not** found in animal cells?

A 1 and 2

B 2 and 3

C 3 and 4

D 4 and 5

3

- 2 The rate of nitrate ion absorption by a root hair cell was measured at different soil nitrate concentrations.

At X, the concentration of nitrate in the soil is the same as in the cell.

Which graph shows how the rate of absorption varies with nitrate concentration in the soil?

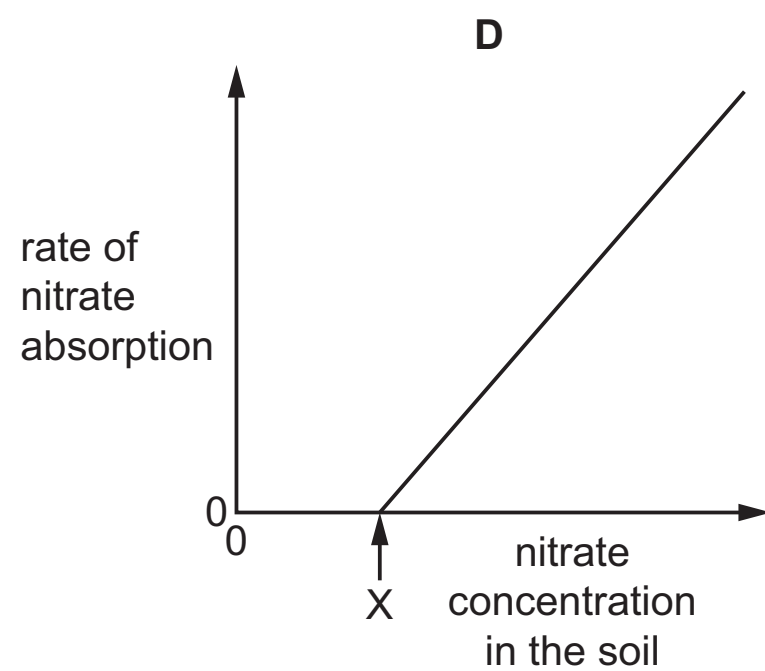
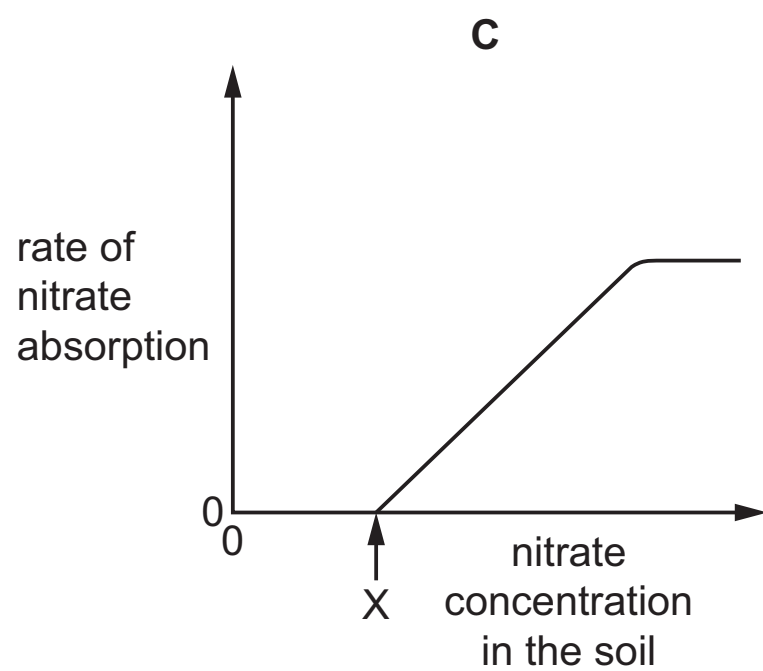
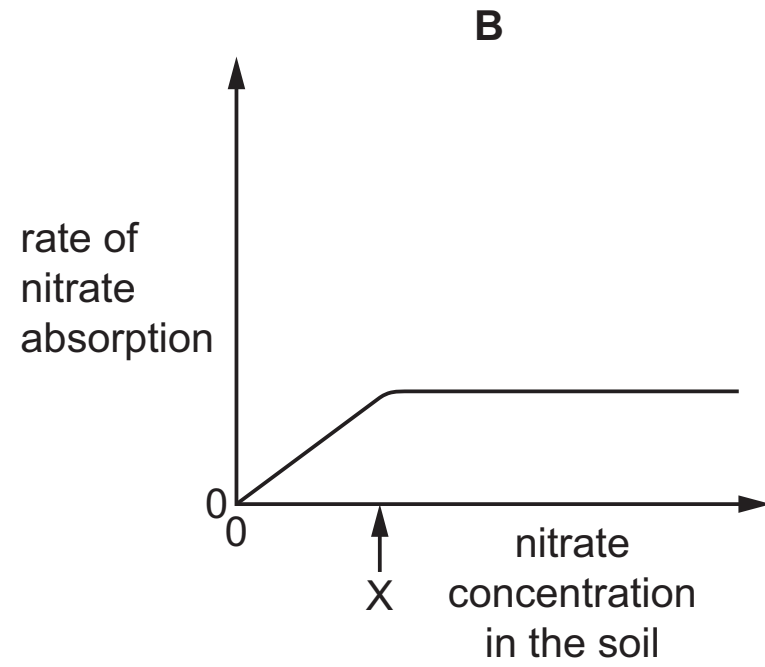
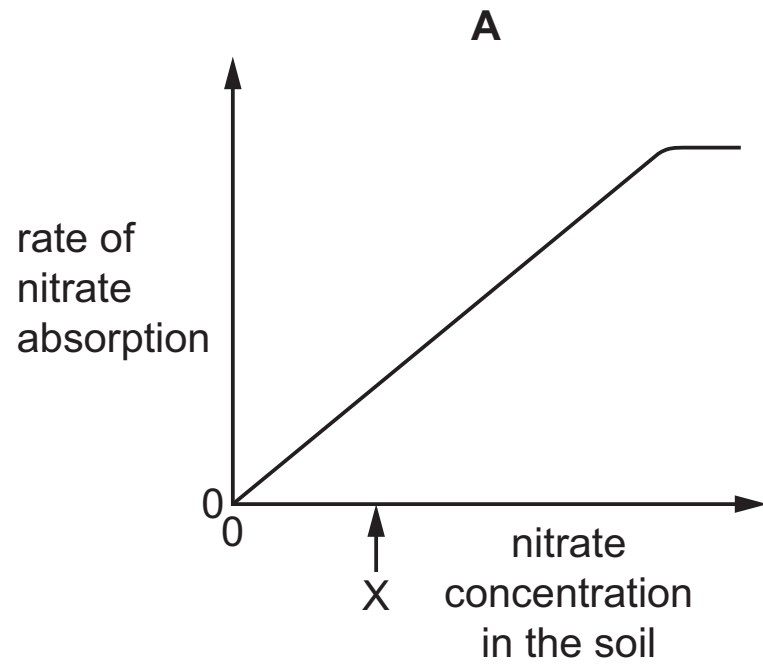

- 3 The diagram represents apparatus used to investigate osmosis.

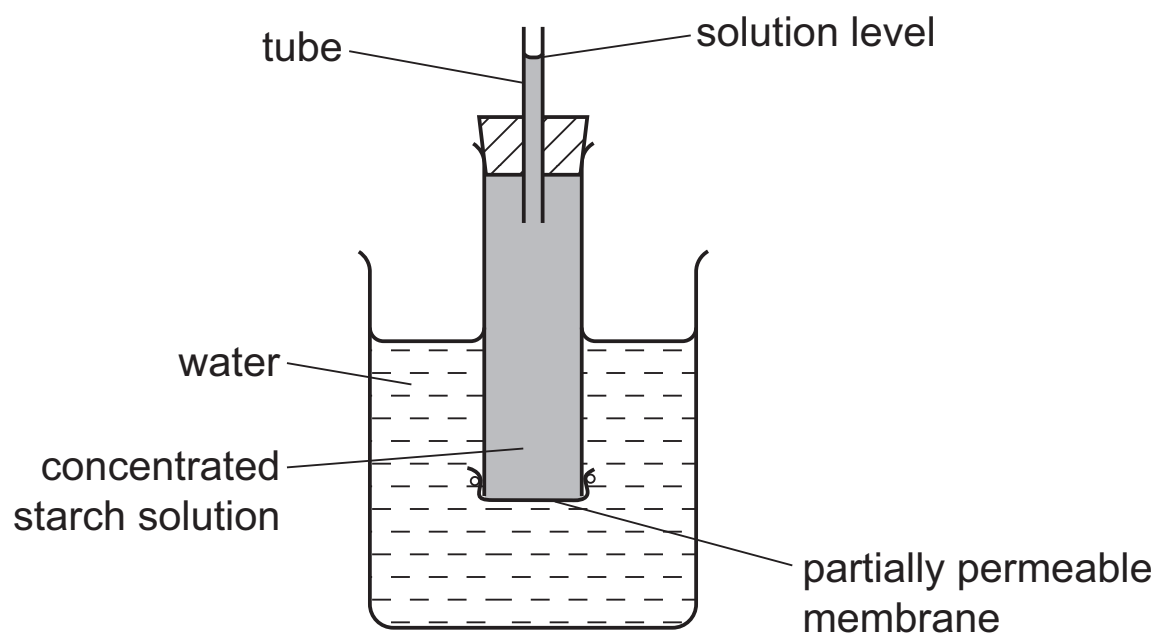

Which molecules will move across the partially permeable membrane and which change will occur in the solution level?

	molecules	solution level
A	starch	fall
B	starch	rise
C	water	fall
D	water	rise

- 4 Starch digestion occurs in the mouth cavity and in the duodenum but it stops in the stomach.

Why is this?

- A** All the starch has been digested before it reaches the stomach.
 - B** Cells in the stomach do not produce amylase.
 - C** The pH in the stomach alters the shape of the amylase.
 - D** The temperature in the stomach is too high for amylase to work.
- 5 One of the tissues in a leaf was described as consisting of 'loosely packed cells with a layer of moisture on their surface to dissolve gases so that the gases can diffuse into the cells'.

To which tissue is this description referring?

- A** epidermis
- B** palisade mesophyll
- C** spongy mesophyll
- D** vascular bundle

- 6 A growing plant is regularly watered with a solution. The composition of the solution is changed after which the plant's leaves become yellow in colour.

How can this problem be corrected?

- A adding amino acids to the solution
- B adding magnesium ions to the solution
- C bubbling carbon dioxide through the solution
- D bubbling oxygen through the solution

7 The diagram shows a green shoot photosynthesising under a glass jar. This was used as a control experiment in a laboratory investigation.

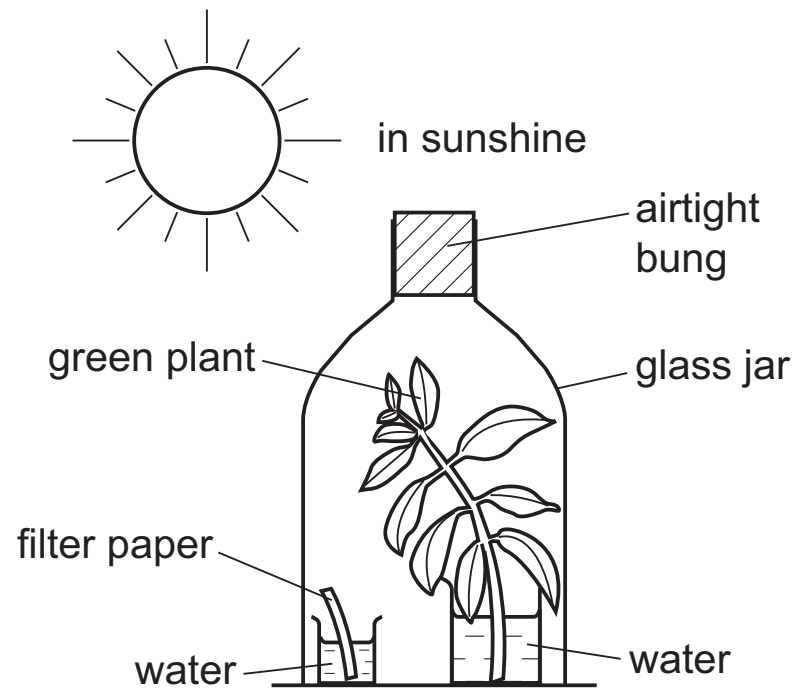

Which diagram shows the experiment carried out to investigate the need for carbon dioxide in photosynthesis?

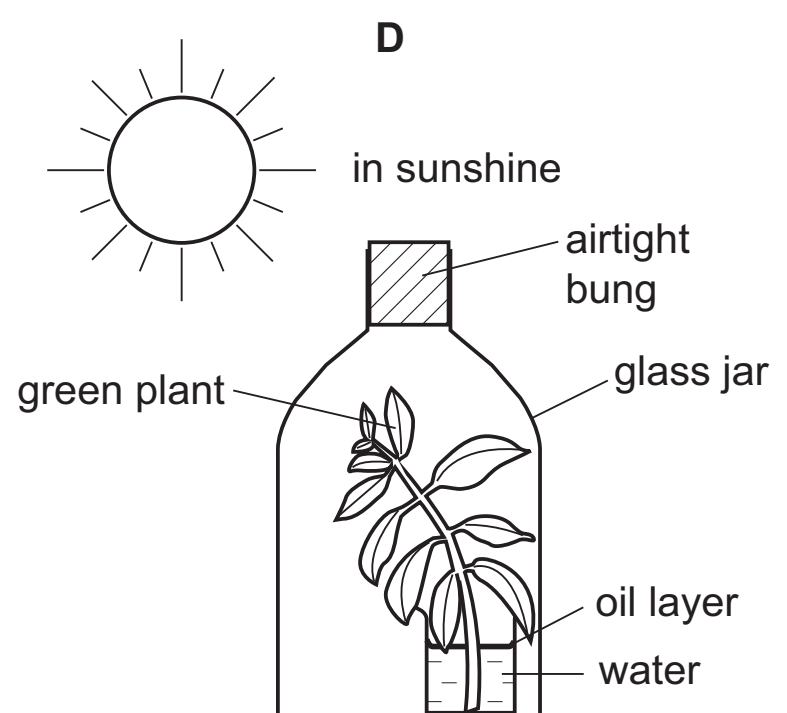
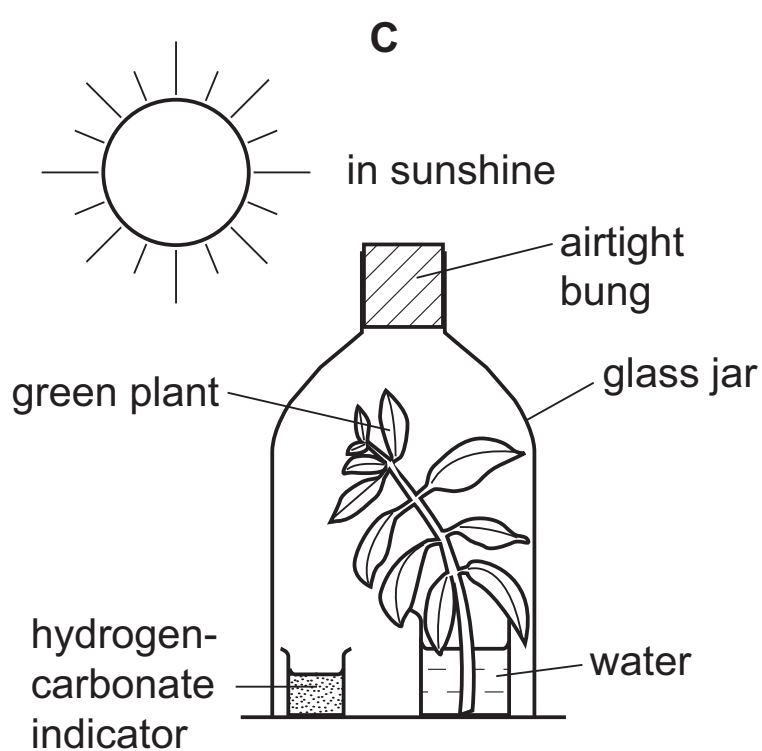
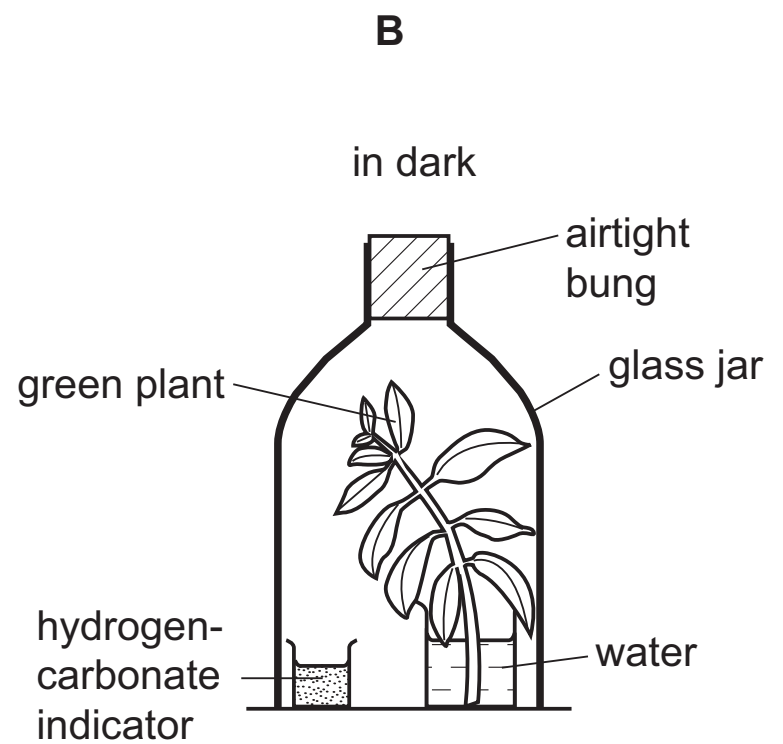
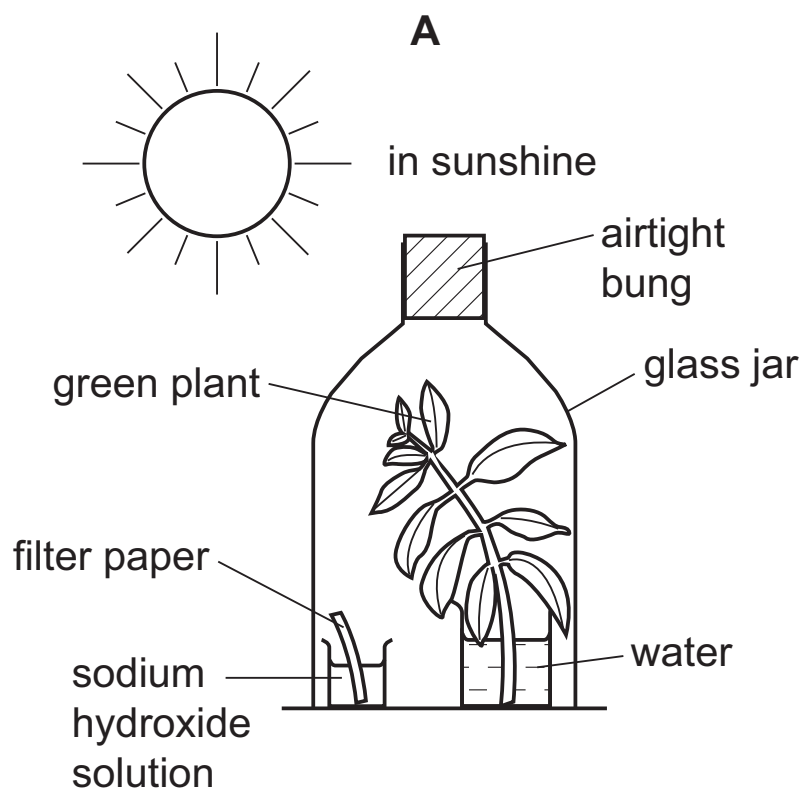

8 The diagram shows the alimentary canal and some associated organs.

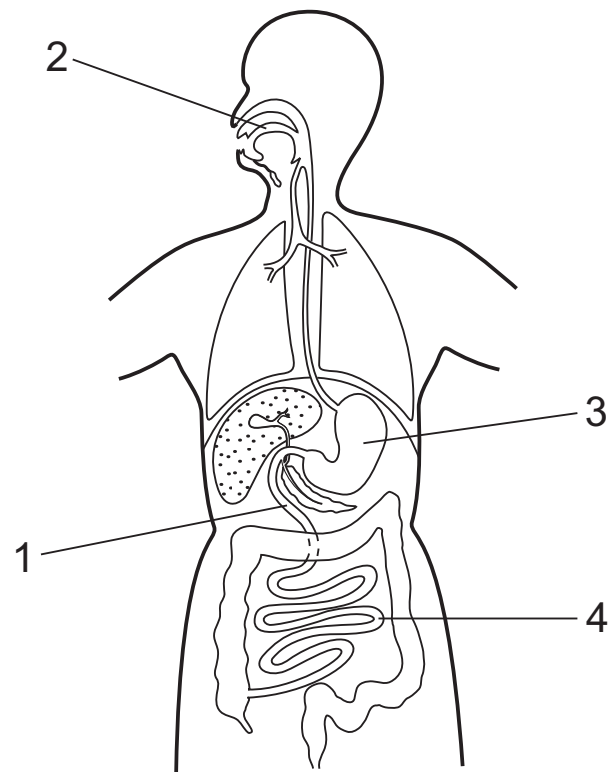

Which row shows where amylase is released?

	1	2	3	4	
A	✓	✓	x	x	key ✓ = yes x = no
B	✓	x	✓	x	
C	x	✓	✓	x	
D	x	✓	x	✓	

9 The diagram shows a section of the wall of the small intestine.

Into which structure are most lipid components absorbed for transport to the rest of the body?

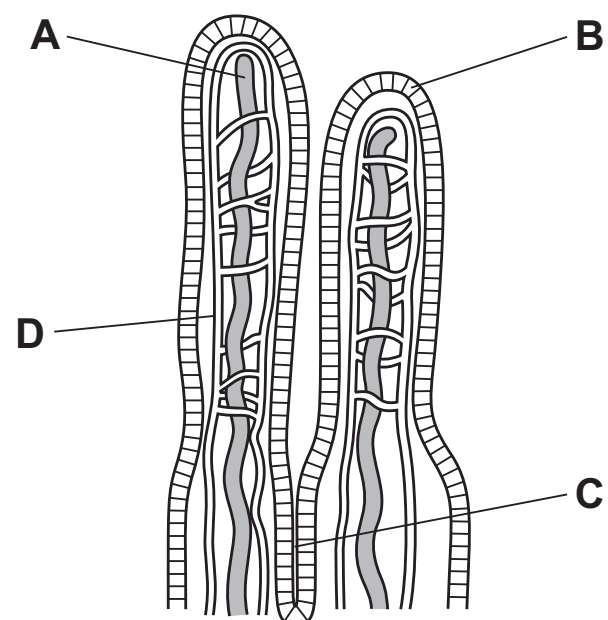

10 Which chemical change does **not** occur in the liver?

- A amino acids to glucose
- B glucose to amino acids
- C glucose to glycogen
- D glycogen to glucose

11 In which direction do water molecules move in the phloem and in the xylem of a plant stem?

	phloem	xylem
A	down only	up only
B	up only	down only
C	up only	both up and down
D	both up and down	up only

12 The photomicrograph shows part of a section through a root.

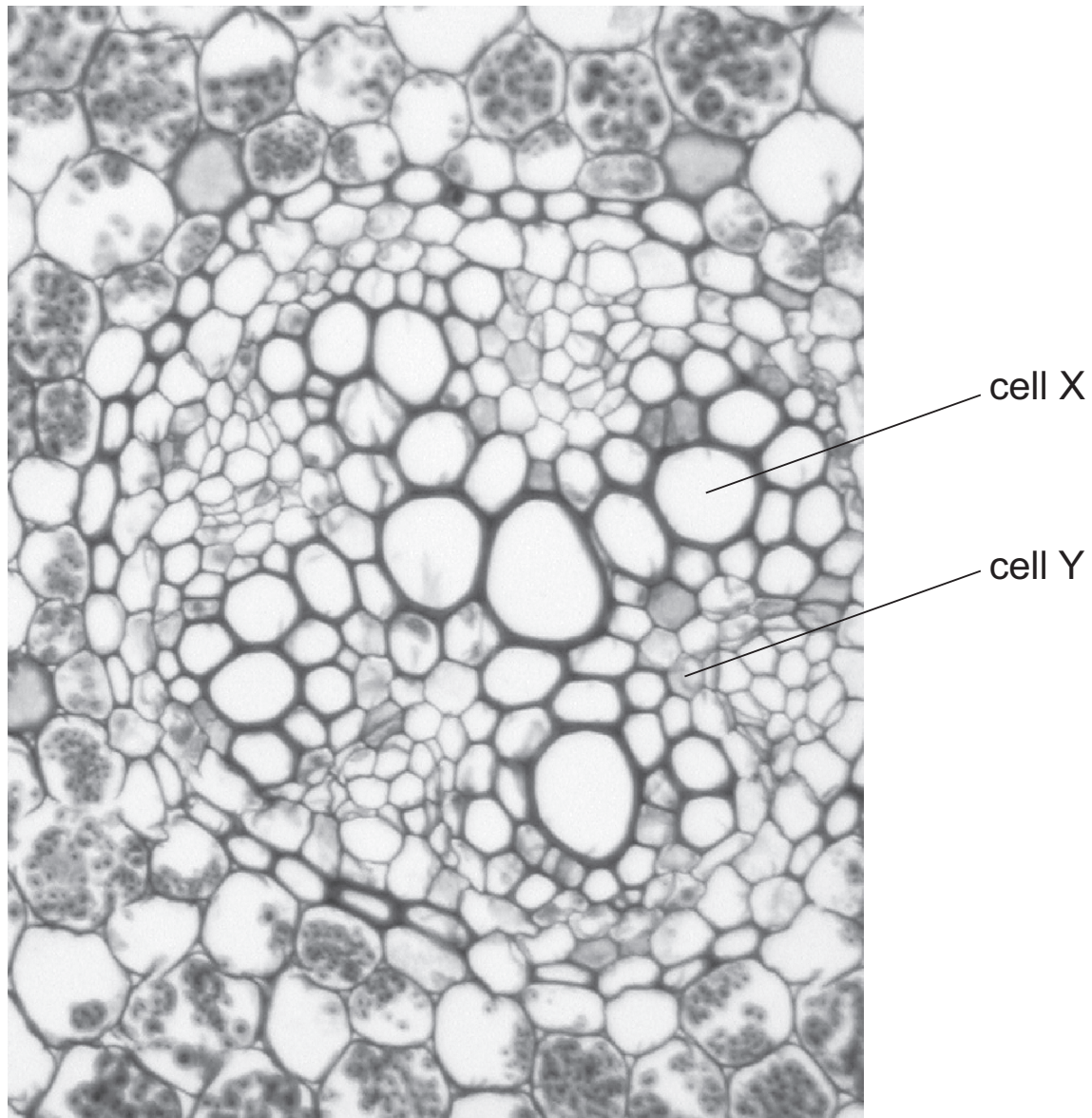

The contents of cell X and the contents of cell Y are each tested with Benedict's solution and with iodine solution.

Which results are expected?

	cell X		cell Y	
	Benedict's solution	iodine solution	Benedict's solution	iodine solution
A	+	+	-	-
B	+	-	+	+
C	-	+	-	+
D	-	-	+	-

key

+ = positive result

- = negative result

13 The photograph shows a cross-section of an artery.

Which labelled part would be of the same thickness in a vein?

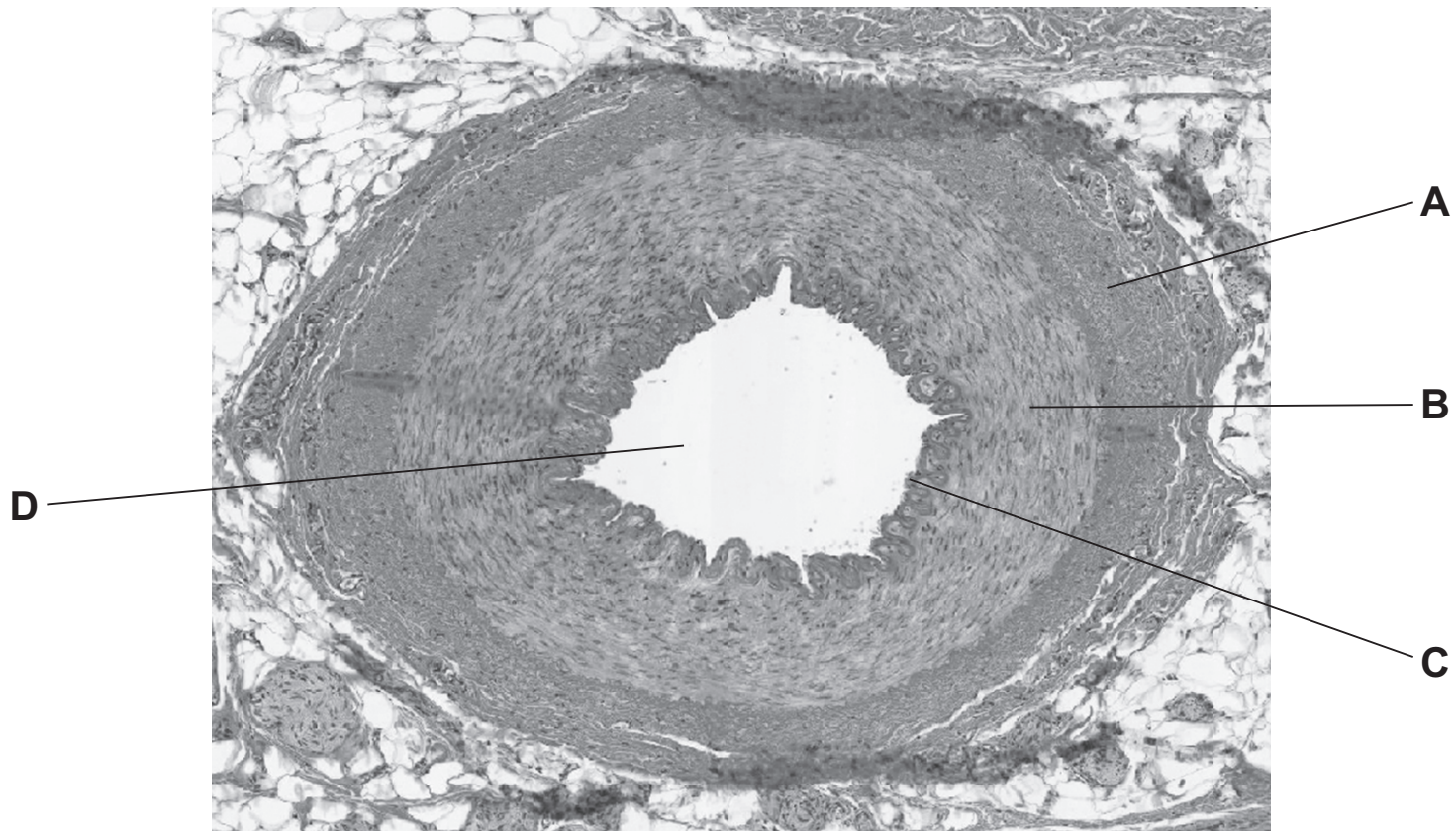

14 In a muscle, which two substances show net movement from the plasma **into** the tissue fluid?

- A carbon dioxide and glucose
- B carbon dioxide and lactic acid
- C glucose and oxygen
- D lactic acid and oxygen

15 The diagram shows an external view of the heart.

The left coronary artery is blocked at the point labelled X.

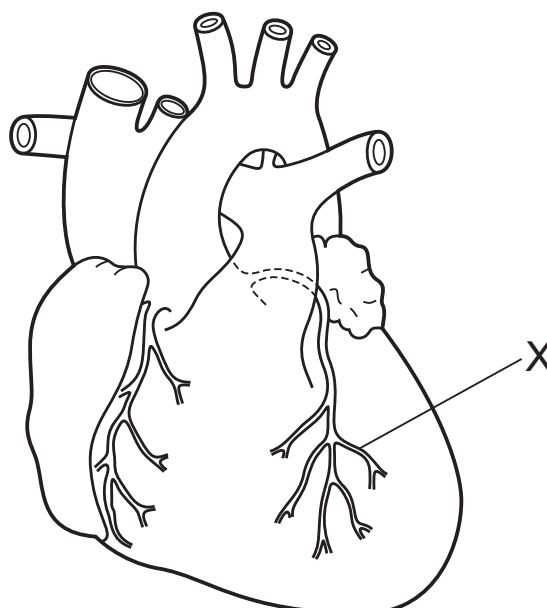

How would the blockage first affect the heart?

- A** Blood is prevented from entering the heart.
 - B** Cells in the wall of the left ventricle die.
 - C** The rate of contraction of the heart increases.
 - D** The valves of the heart allow blood to flow backwards.
- 16** In a sprint race, athletes may have sharp muscle pains because the respiring cells produce
- A** alcohol.
 - B** carbon dioxide.
 - C** glucose.
 - D** lactic acid.

17 The diagram shows some structures in the respiratory system.

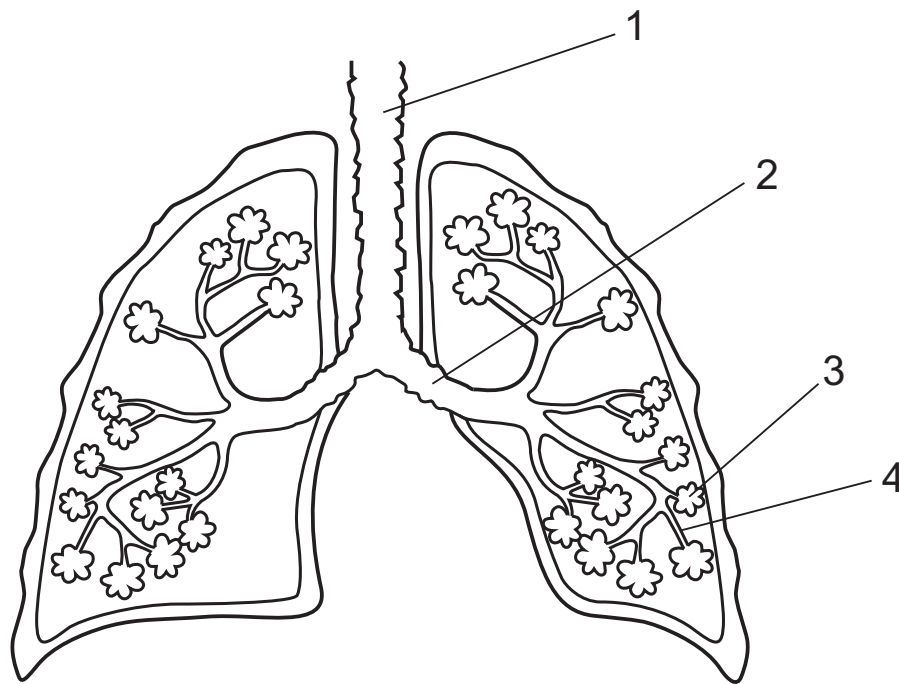

What are the labelled structures?

	1	2	3	4
A	bronchus	trachea	bronchiole	alveolus
B	trachea	bronchiole	alveolus	bronchus
C	trachea	bronchus	alveolus	bronchiole
D	trachea	bronchus	bronchiole	alveolus

18 The diagram shows apparatus used to investigate respiration.

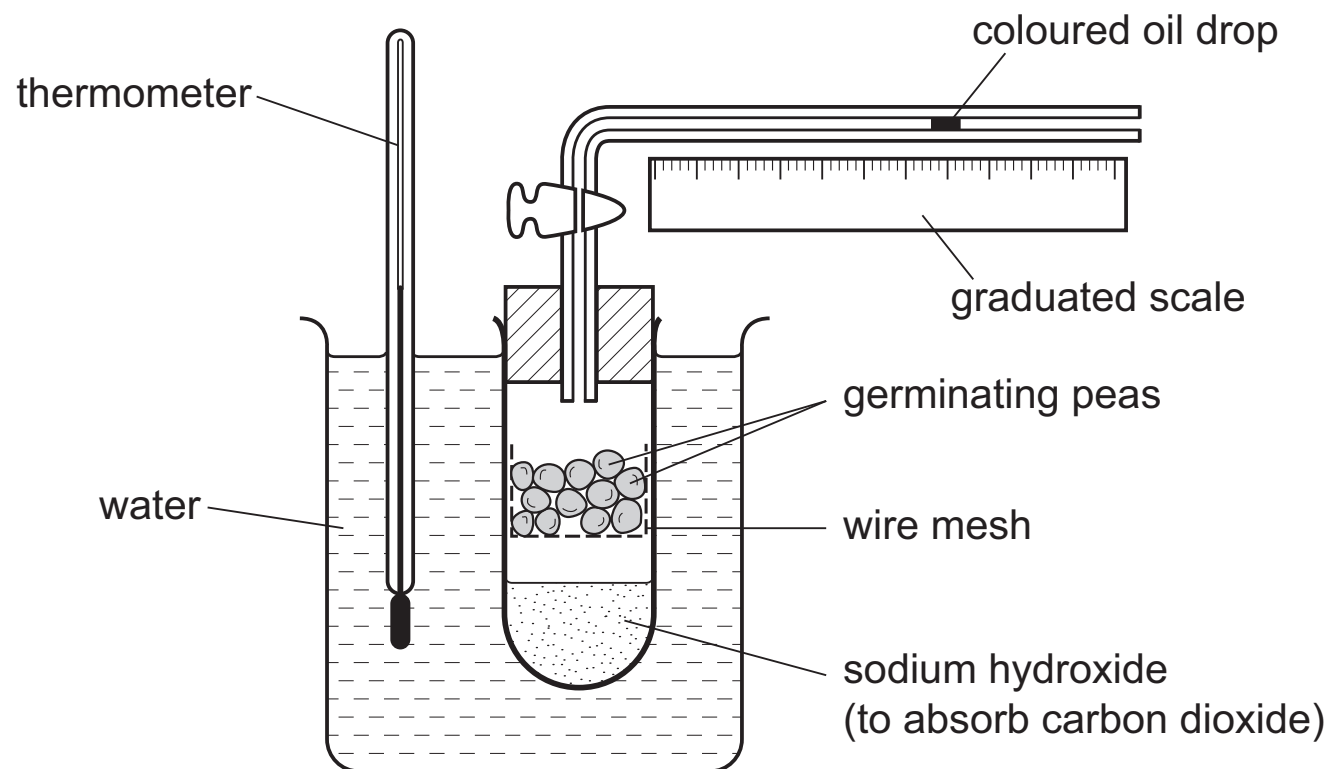

Which change will be seen and what is the explanation?

	change	explanation
A	oil drop moves left	oxygen is used up by the peas
B	oil drop does not move	oxygen is used up as fast as carbon dioxide is released
C	oil drop does not move	carbon dioxide is absorbed
D	oil drop moves right	peas release carbon dioxide

19 The diagram shows a joint between two bones in the human arm.



What correctly describes the joint?

- A** a ball and socket joint between humerus and radius
- B** a ball and socket joint between humerus and ulna
- C** a hinge joint between humerus and radius
- D** a hinge joint between humerus and ulna

20 Which row shows the parts of the urinary system that carry out different functions?

	makes urine	carries urine	holds urine	removes urine from body
A	bladder	ureter	urethra	kidney
B	bladder	urethra	ureter	kidney
C	kidney	ureter	bladder	urethra
D	kidney	urethra	bladder	ureter

21 On a hot day, how does the skin react to lower the internal temperature of the body?

- A** arterioles constrict, sweat production decreases, hairs stand on end
- B** arterioles constrict, sweat production increases, hairs lie flat against the skin
- C** arterioles dilate, sweat production decreases, hairs lie flat against the skin
- D** arterioles dilate, sweat production increases, hairs lie flat against the skin

22 The eye changes focus from looking at a wristwatch to looking at an aeroplane flying overhead.

Which changes occur inside the eye?

	shape of lens	suspensory ligaments	ciliary muscles
A	thicker	slack	contract
B	thicker	tight	relax
C	thinner	slack	contract
D	thinner	tight	relax

23 A person is sitting in a darkened room. After five seconds, a light is turned on. Five seconds after that, the light is turned off again.

Which graph shows the changes in the diameters of their pupils?

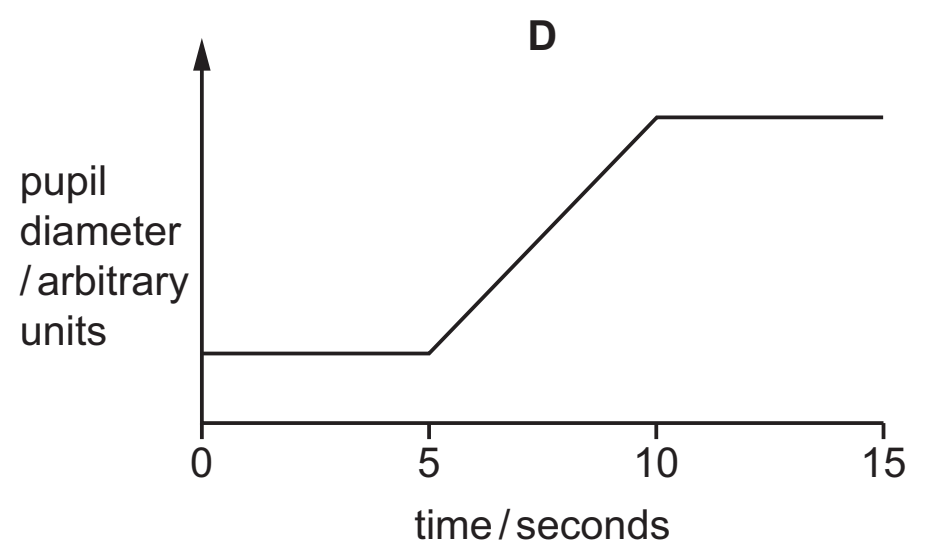
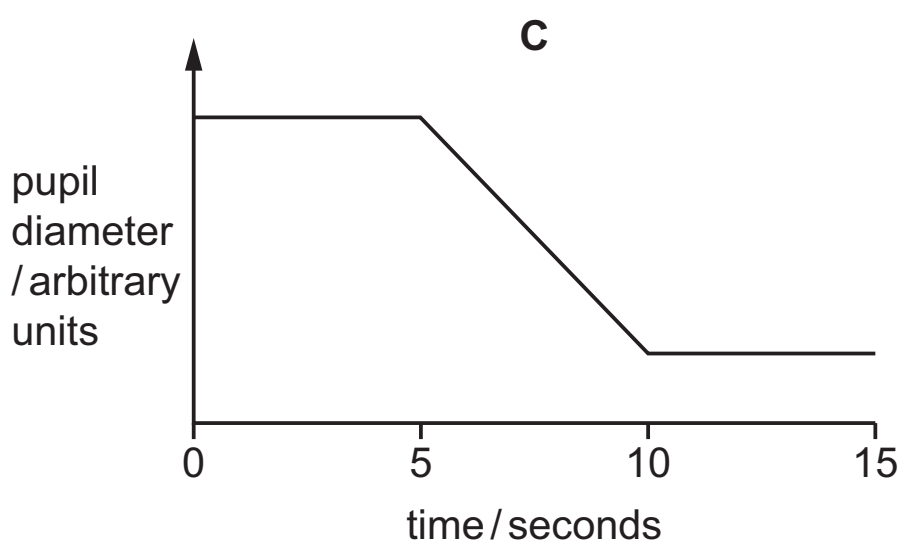
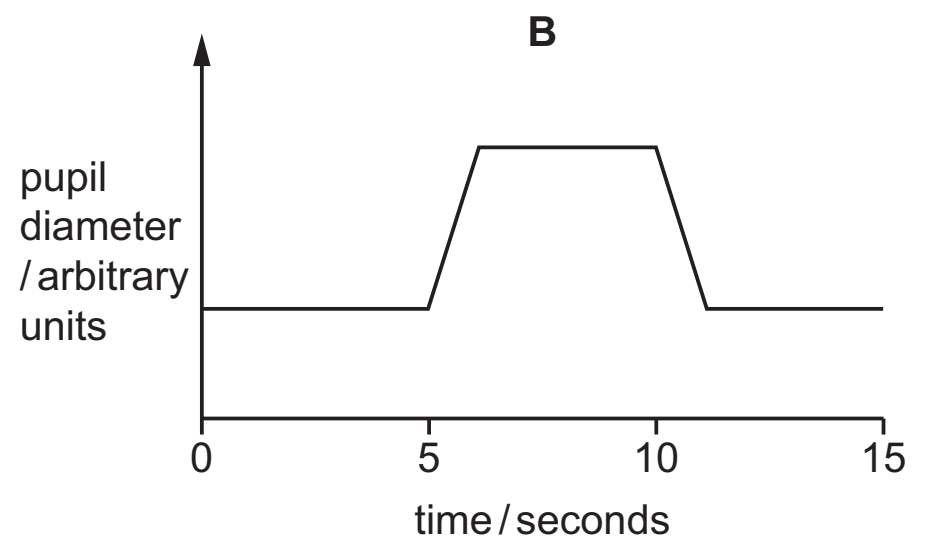
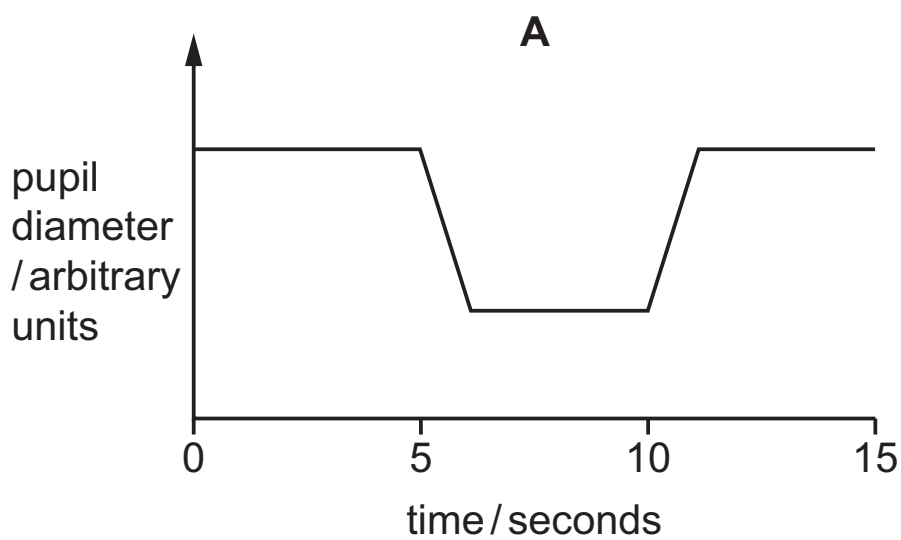

24 Nerve impulses in neurones can travel

- 1 away from the central nervous system
- 2 towards the central nervous system
- 3 within the central nervous system

In which direction do impulses in sensory and relay neurones travel?

	sensory neurone	relay neurone
A	1	2
B	1	3
C	2	1
D	2	3

25 Which is an antibiotic?

- A a chemical produced by a bacterium that kills viruses
- B a chemical produced by a fungus that kills bacteria
- C a chemical produced by a plant that kills viruses
- D a chemical produced by the human body that kills bacteria

26 A new organism is discovered. It contains DNA in a cellular structure.

To which group of organisms could it belong and to which group could it **not** belong?

	could belong to	could not belong to
A	bacteria	fungi
B	bacteria	viruses
C	fungi	bacteria
D	viruses	bacteria

27 The diagram shows an industrial fermenter.

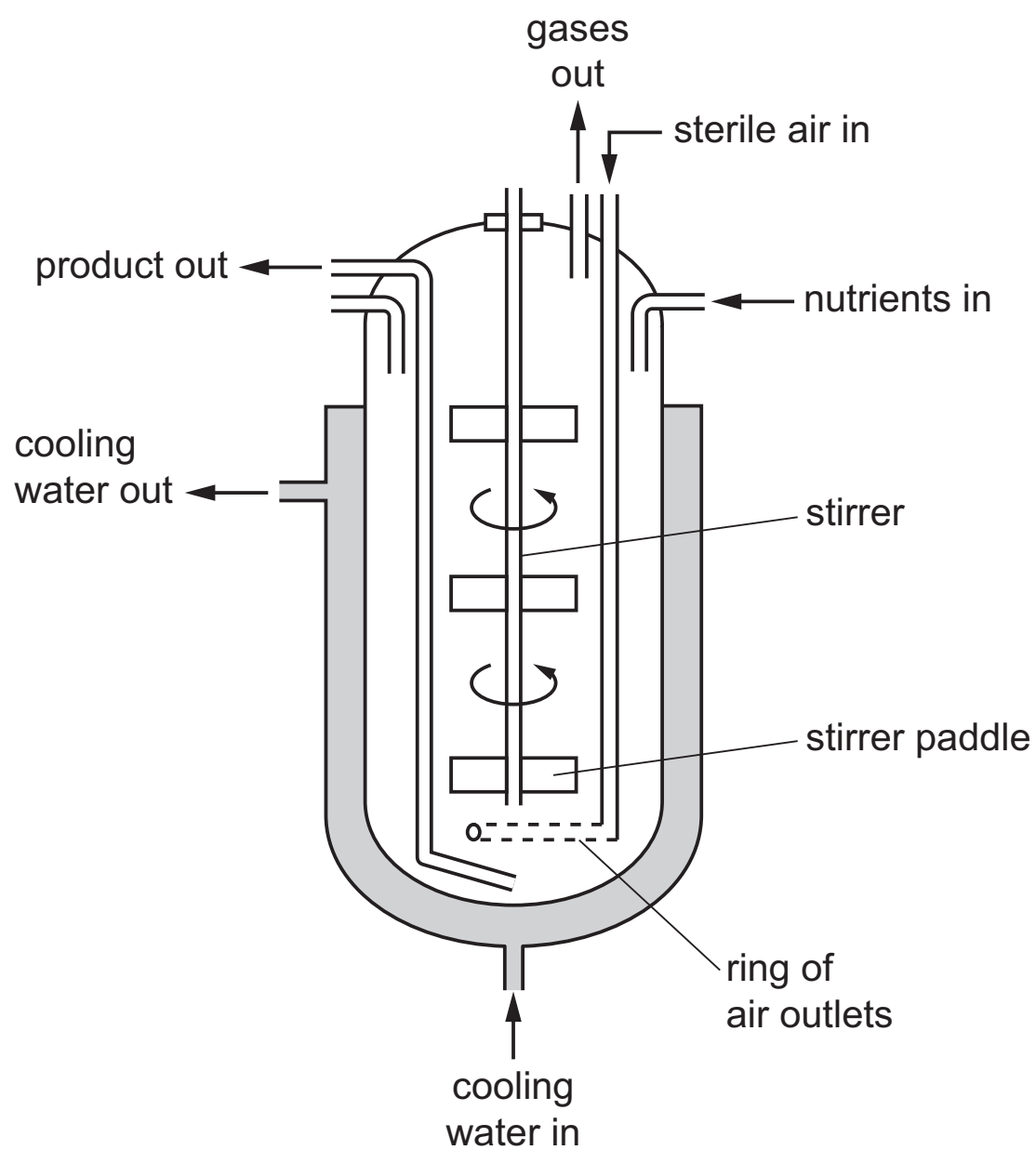

Why is sterile air essential for the microorganisms in the fermenter?

- A** to lower the temperature
 - B** to maintain the fungus in suspension
 - C** to provide oxygen
 - D** to stir the microorganisms and nutrients
- 28 Which statement is correct for the flow of energy through an ecosystem?
- A** All organisms lose energy from metabolic processes to the environment.
 - B** An organism in a food chain passes on as much energy as it receives.
 - C** Energy from decomposition is essential for the growth of plant roots.
 - D** Top carnivores represent the final stage in the flow of energy.

29 The diagram shows a pyramid of biomass.

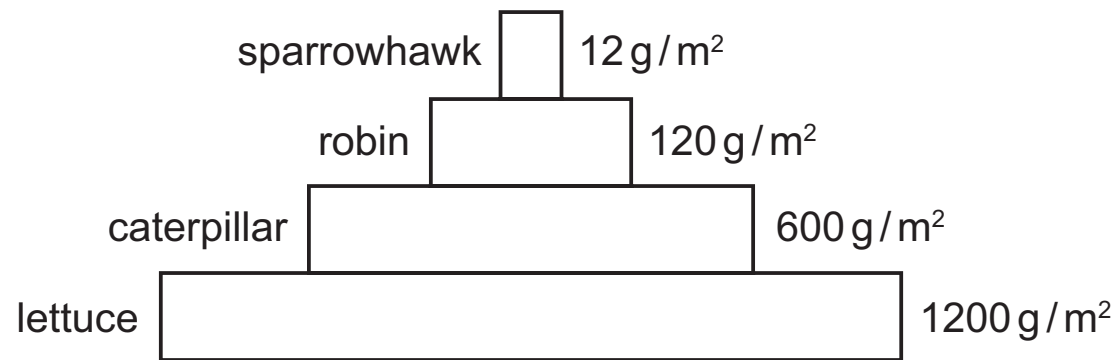

Which percentage of biomass is passed from the primary consumer to the secondary consumer?

- A** 1% **B** 10% **C** 20% **D** 50%

30 In which process is atmospheric nitrogen absorbed in root nodules and combined with other compounds?

- A** nitrification
B nitrogen fixation
C putrefaction
D diffusion

31 How many times must an uninfected mosquito feed on human blood to transmit the malarial parasite in the human population?

- A** only once
B at least twice
C at least three times
D more than three times

32 Why does the oxygen concentration in a river decrease when sewage is discharged into it?

- A** Less oxygen is absorbed from the air.
B There is a decrease in the number of plants.
C There is an increase in the number of bacteria.
D There is an increase in the number of fish.

33 The diagram shows the development of a pollen tube and its entry into the ovule.

Which part develops into the testa after fertilisation?

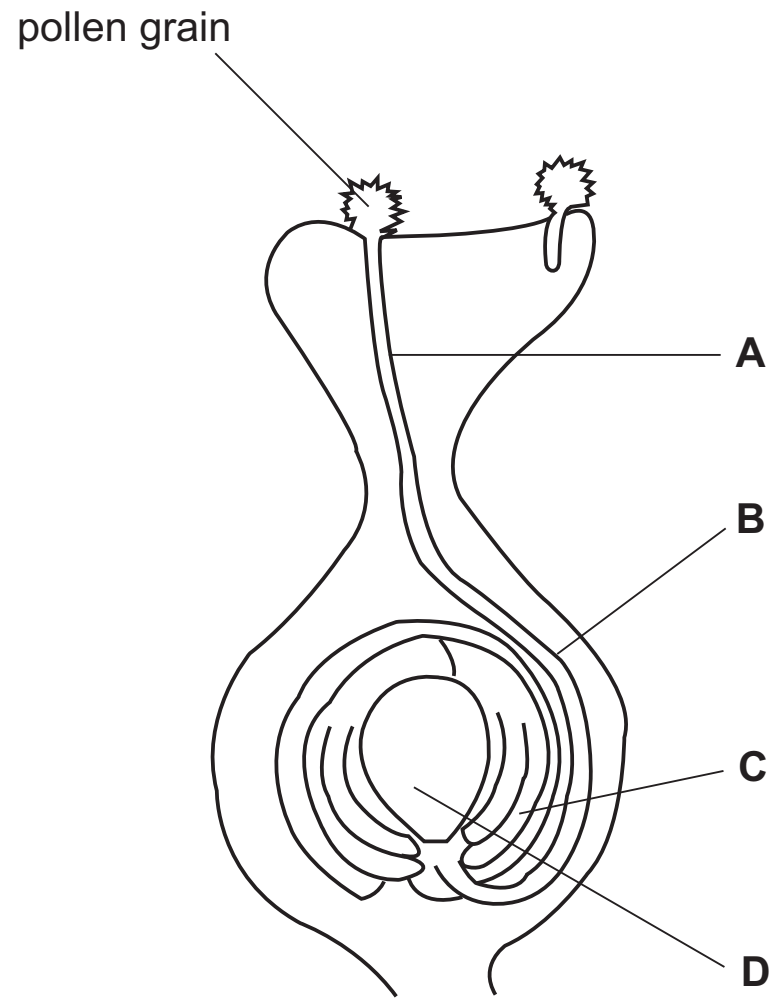

34 The diagram shows a broad bean seedling.

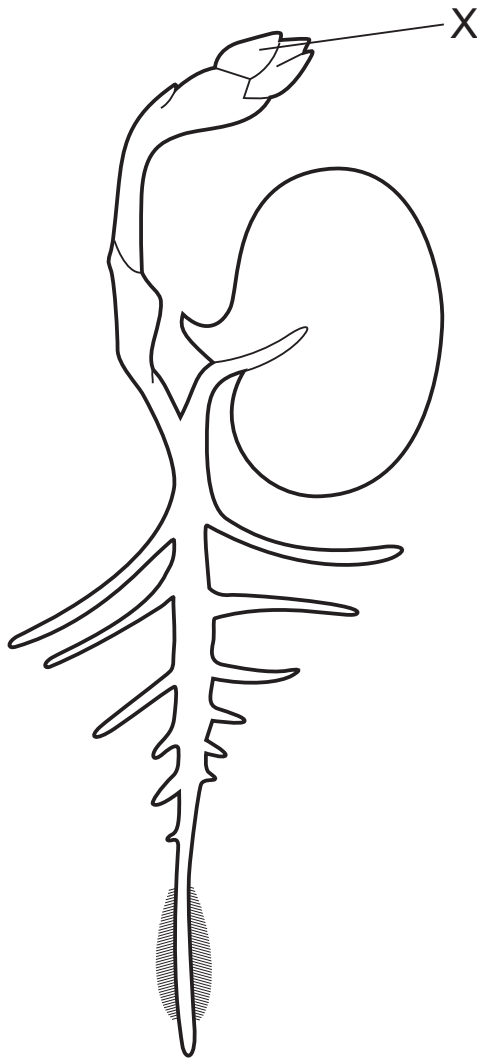

From which part of the seed did structure X develop?

- A cotyledon
- B plumule
- C radicle
- D testa

35 The diagram shows part of the male reproductive and urinary systems.

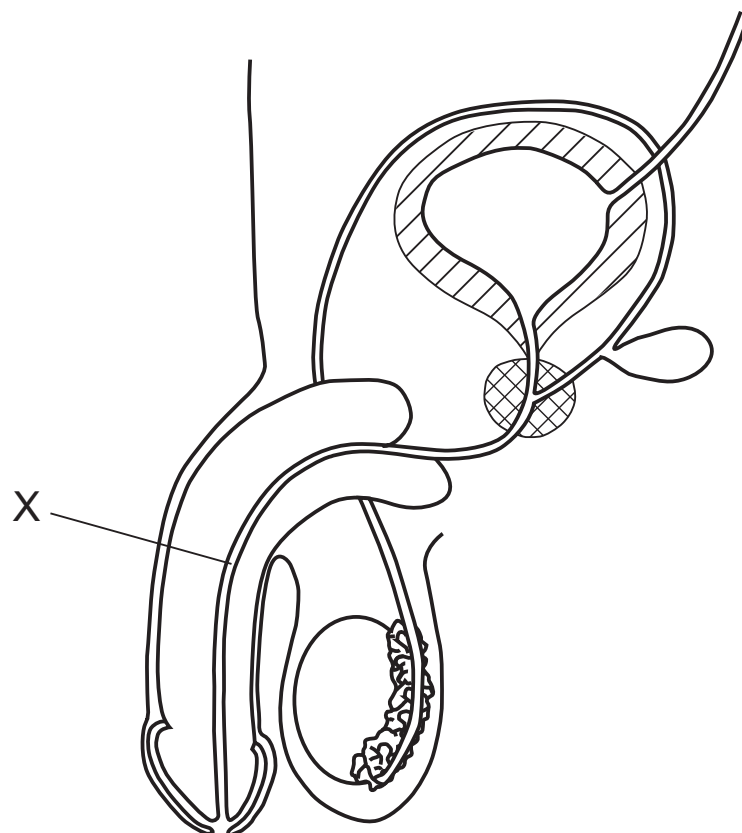

What is X?

- A prostate gland
- B sperm duct
- C ureter
- D urethra

36 What are the functions of the amniotic sac and the amniotic fluid?

- A act as a barrier to the passage of bacteria and allow the transfer of some antibodies to the fetus
- B protect the fetus from physical shock and allow the fetus to move freely
- C provide soluble nutrients such as glucose and mineral ions for the fetus
- D supply oxygen to, and remove carbon dioxide from, the fetus

37 Which process is used to produce insulin commercially?

- A extracting glycogen from the liver to stimulate production of insulin
- B extracting insulin from the pancreas of human volunteers
- C inserting a bacterial gene into a person's pancreas cells
- D inserting the human insulin gene into a bacterium

38 The inheritance of the ABO blood groups depends on three alleles I^A , I^B and I^O .

What are the possible genotypes for a person of blood group A?

- A $I^A I^A$ only
- B $I^A I^A$, and $I^A I^B$ only
- C $I^A I^A$, and $I^A I^O$ only
- D $I^A I^A$, $I^A I^O$ and $I^A I^B$

39 Two heterozygous individuals are crossed. Some of the offspring show the recessive characteristic.

What is the probability that one of these offspring that shows the recessive characteristic is homozygous?

- A 0.00
- B 0.25
- C 0.50
- D 1.00

40 The diagram shows a pair of chromosomes from the same cell.

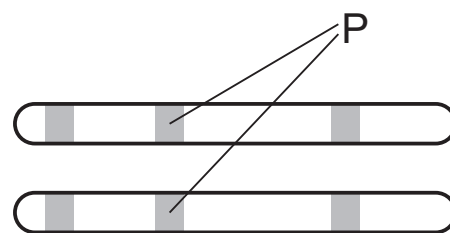

What do the lines labelled P point to?

- A the site of alleles made up of two or more genes which are always the same
- B the site of alleles made up of two or more genes which might be different
- C the site of genes made up of two or more alleles which are always the same
- D the site of genes made up of two or more alleles which might be different

BLANK PAGE

BLANK PAGE

Permission to reproduce items where third-party owned material protected by copyright is included has been sought and cleared where possible. Every reasonable effort has been made by the publisher (UCLES) to trace copyright holders, but if any items requiring clearance have unwittingly been included, the publisher will be pleased to make amends at the earliest possible opportunity.

To avoid the issue of disclosure of answer-related information to candidates, all copyright acknowledgements are reproduced online in the Cambridge International Examinations Copyright Acknowledgements Booklet. This is produced for each series of examinations and is freely available to download at www.cie.org.uk after the live examination series.

Cambridge International Examinations is part of the Cambridge Assessment Group. Cambridge Assessment is the brand name of University of Cambridge Local Examinations Syndicate (UCLES), which is itself a department of the University of Cambridge.