



Cambridge O Level

PHYSICS

5054/12

Paper 1 Multiple Choice

October/November 2022

1 hour

You must answer on the multiple choice answer sheet.

You will need: Multiple choice answer sheet
Soft clean eraser
Soft pencil (type B or HB is recommended)

INSTRUCTIONS

- There are **forty** questions on this paper. Answer **all** questions.
- For each question there are four possible answers **A, B, C** and **D**. Choose the **one** you consider correct and record your choice in soft pencil on the multiple choice answer sheet.
- Follow the instructions on the multiple choice answer sheet.
- Write in soft pencil.
- Write your name, centre number and candidate number on the multiple choice answer sheet in the spaces provided unless this has been done for you.
- Do **not** use correction fluid.
- Do **not** write on any bar codes.
- You may use a calculator.

INFORMATION

- The total mark for this paper is 40.
- Each correct answer will score one mark.
- Any rough working should be done on this question paper.

This document has **16** pages.



- 1 The diagram shows three forces acting on a block. The resultant force is 6 N to the right.

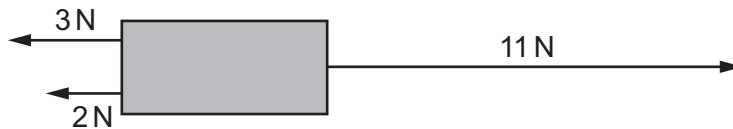

Which additional force produces a resultant force of 3 N to the left?

- A** 3 N to the left
B 9 N to the left
C 6 N to the right
D 13 N to the right
- 2 A teacher measures the length of her classroom.
What is the most appropriate instrument to use?
- A** a 30 cm ruler
B a caliper
C a micrometer
D a tape
- 3 Which value is one-thousandth of a metre?
- A** 0.0001 cm **B** 0.001 cm **C** 0.01 cm **D** 0.1 cm
- 4 A car of mass 1000 kg is travelling down a steep hill. The brakes fail and the driver uses a horizontal sand-filled safety road to stop the car.
The car enters the sand at a speed of 10 m/s and experiences a constant stopping force of 2500 N.
How far does the car travel in the sand before coming to rest?
- A** 2.0 m **B** 4.0 m **C** 20 m **D** 40 m

- 5 A ball starts from rest and rolls down a steep slope. The ball then rolls along rough horizontal ground.

Which graph shows the speed of the ball at different times?

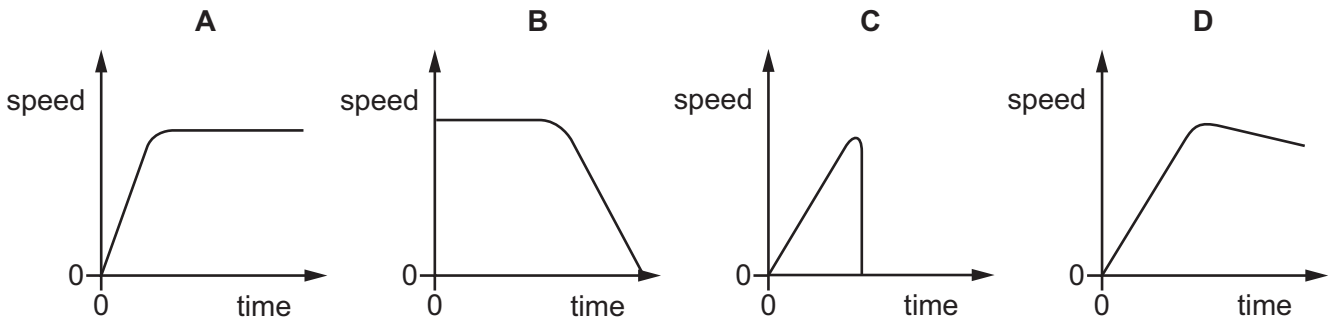

- 6 A block of wood is placed on a table. External forces act on the block but the block remains stationary.

A student suggests three conditions for the block to remain stationary.

condition P The resultant force on the block **must** equal zero.

condition Q The resultant moment on the block **must** equal zero.

condition R The external forces **must** act through the centre of mass of the block.

Which conditions are necessary for the block to remain stationary?

- A** P and Q only **B** P and R only **C** Q and R only **D** P, Q and R

- 7 A car travels at 60 km/h on a straight road. The road is dry. The driver applies the brakes suddenly. The table shows the thinking distance, the braking distance and the stopping distance.

thinking distance /m	braking distance /m	stopping distance /m
27	22	49

The same car is driven by the same driver at 60 km/h on the same road when it is wet. The driver applies the brakes suddenly again.

What is the effect of the wet road on the thinking distance, the braking distance and the stopping distance?

	thinking distance	braking distance	stopping distance
A	no change	increases	increases
B	no change	no change	no change
C	increases	increases	increases
D	increases	no change	increases

- 8 A car travels on a horizontal road around a bend at constant speed.

What is the direction of the resultant force on the car?

- A backwards
- B forwards
- C towards the centre of the bend
- D towards the road

- 9 A student writes two statements about mass and weight.

- 1 Mass is the property of a body which resists change in its state of rest or motion.
- 2 Weight is the amount of substance in a body.

Which statements are correct?

- A statement 1 only
- B statement 2 only
- C statement 1 and statement 2
- D neither statement 1 nor statement 2

- 10 The graph shows how the extension of a spring changes with the masses suspended from it when the spring is on planet X and when the spring is on planet Y.

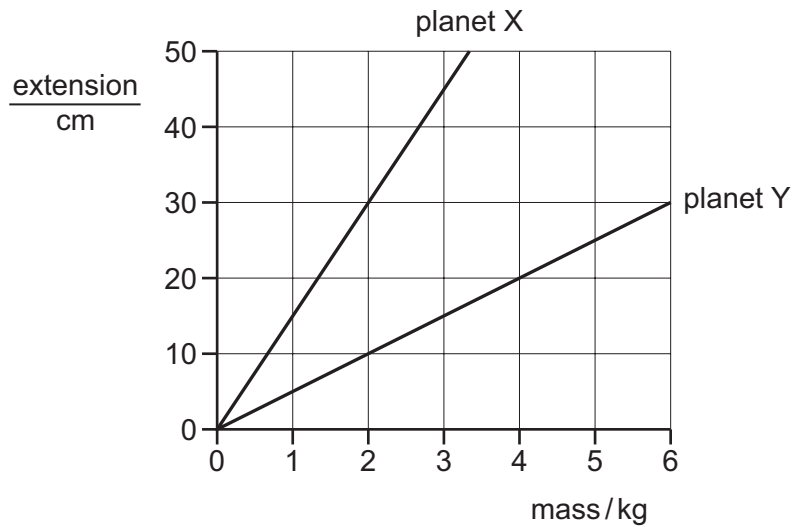

Which conclusion can be drawn from these graphs?

- A** It is not possible to compare the gravitational field strengths on planets X and Y.
- B** The gravitational field strength on planet X is equal to the gravitational field strength on planet Y.
- C** The gravitational field strength on planet X is one third of the gravitational field strength on planet Y.
- D** The gravitational field strength on planet X is three times the gravitational field strength on planet Y.
- 11 A student finds the density of an irregularly shaped object. He chooses his equipment from this list.

- 1 stop-watch
- 2 measuring cylinder
- 3 balance

Which equipment does the student need to use?

- A** 1, 2 and 3 **B** 1 and 2 only **C** 1 and 3 only **D** 2 and 3 only

- 12 A uniform beam is pivoted at its centre. Two weights are placed on the beam in the positions shown and the beam is balanced by an upward force F .

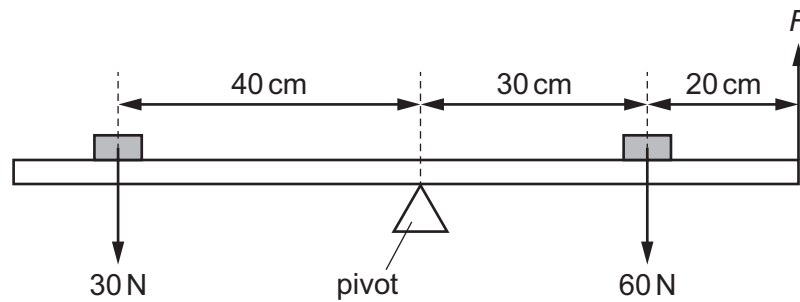

What is the size of F ?

- A 6.0 N B 12 N C 30 N D 60 N
- 13 Four objects of equal mass rest on a table. The centre of mass of each object is labelled G.
- Which object is the least stable?

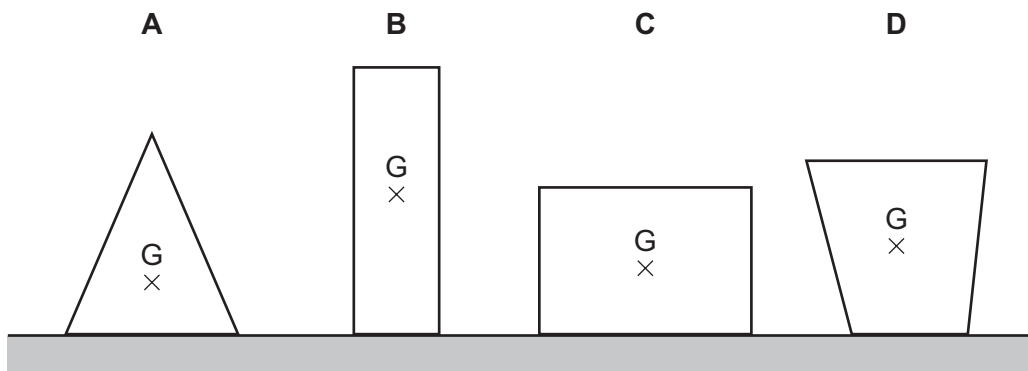

- 14 Each tyre of a car has an area of 100 cm^2 in contact with the ground.

The car has a mass of 1600 kg. The weight of the car is equally distributed amongst the four tyres.

The gravitational field strength g is 10 N/kg .

What is the pressure exerted on the ground?

- A 4.0 N/cm^2 B 16 N/cm^2 C 40 N/cm^2 D 160 N/cm^2
- 15 A gas syringe contains a volume V_1 of gas at pressure p_1 .
- The volume is reduced to V_2 without any change of temperature.
- What is the expression for the **change** in pressure?

- A $\frac{p_1 V_1}{V_2} + p_1$ B $p_1 + \frac{p_1 V_2}{V_1}$ C $\frac{p_1 V_1}{V_2} - p_1$ D $\frac{p_1 V_2}{V_1} - p_1$

- 16 A constant force F pulls a block of weight W up the slope shown.

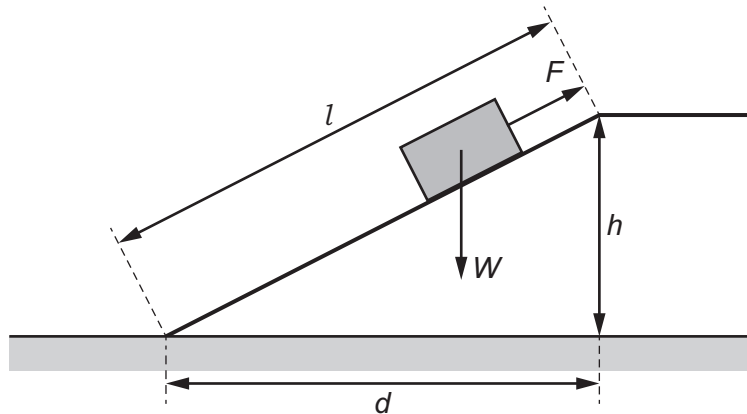

How much work is done by F in pulling the block up the slope?

- A** $F \times h$ **B** $F \times l$ **C** $W \times d$ **D** $W \times l$
- 17 The input power to a motor is 12 W.
The motor wastes 590 J of energy in 1.0 min.
What is the efficiency of the motor?
- A** 18% **B** 22% **C** 55% **D** 82%
- 18 Electric motors have an efficiency of about 90% when used in an electric train.
Which forms of wasted energy are produced?
- A** sound only
B thermal only
C thermal and chemical
D thermal and sound
- 19 What is a unit of power?

- A** Js **B** J/s **C** Ns **D** N/s

20 The diagrams represent four thermometers.

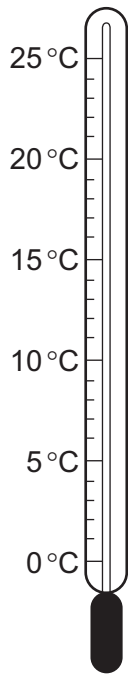

P

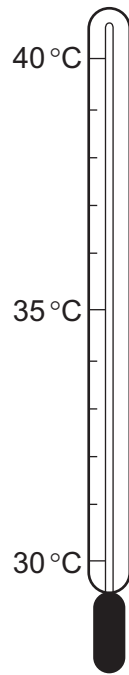

Q

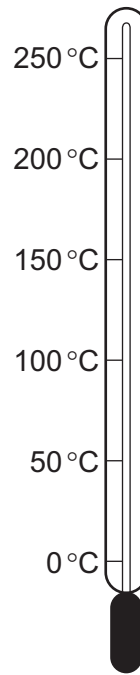

R

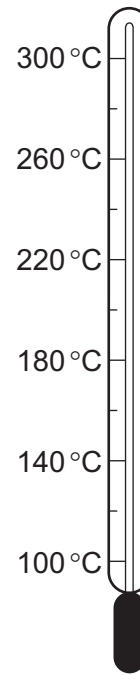

S

Which thermometer has the greatest sensitivity and which thermometer has the greatest range?

	greatest sensitivity	greatest range
A	P	R
B	P	S
C	Q	R
D	Q	S

- 21 Air is trapped in a metal cylinder by a piston. The piston is free to move and the trapped air is at atmospheric pressure.

The cylinder is in hot water.

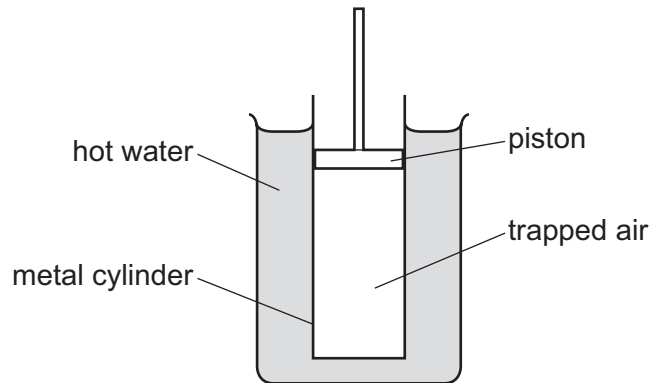

The cylinder is taken out of the water and left to cool.

What happens to the mass of the air in the cylinder and its pressure as it cools?

	mass of air	pressure of air
A	does not change	does not change
B	does not change	changes
C	changes	does not change
D	changes	changes

- 22 A mirror is placed in the path of a ray of light.

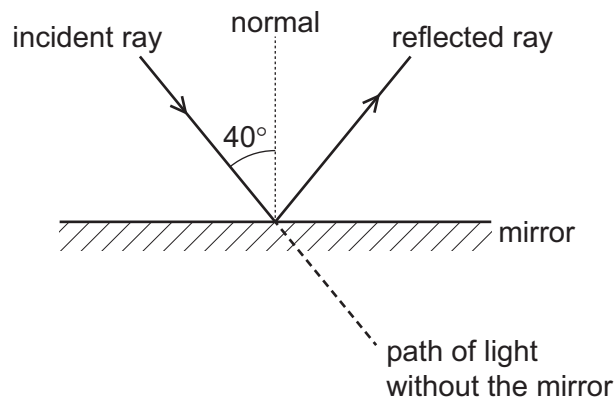

Through which angle does the direction of the ray of light change?

- A** 40° **B** 90° **C** 100° **D** 140°

23 A ray of light in water is refracted at the surface into air.

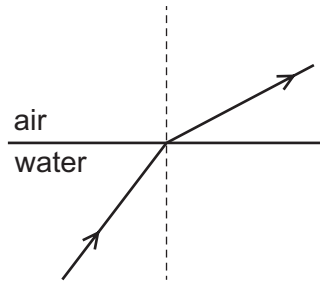

Which diagram shows the angle of incidence i and the angle of refraction r ?

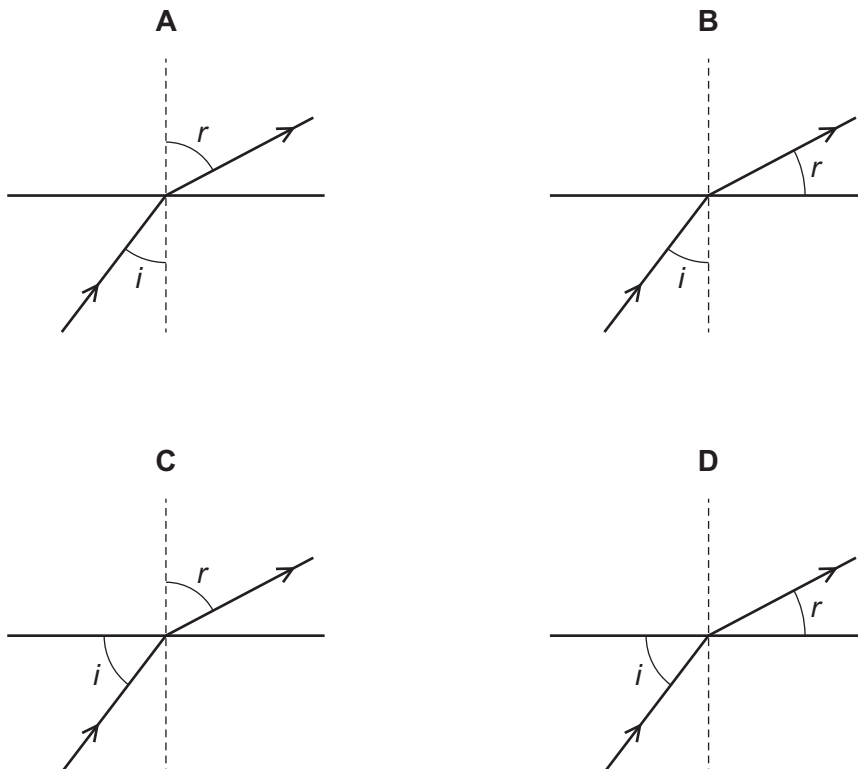

24 A thin converging lens forms a real, focused image of an object, as shown.

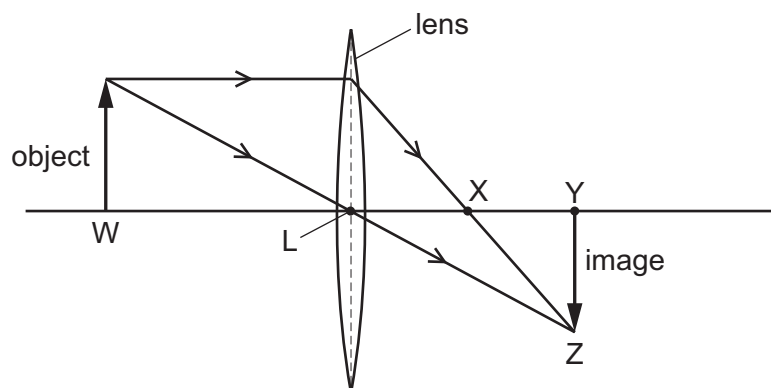

Which distance is equal to the focal length of the lens?

- A** LW **B** LX **C** LY **D** LZ

25 Which ray diagram shows the action of a diverging lens?

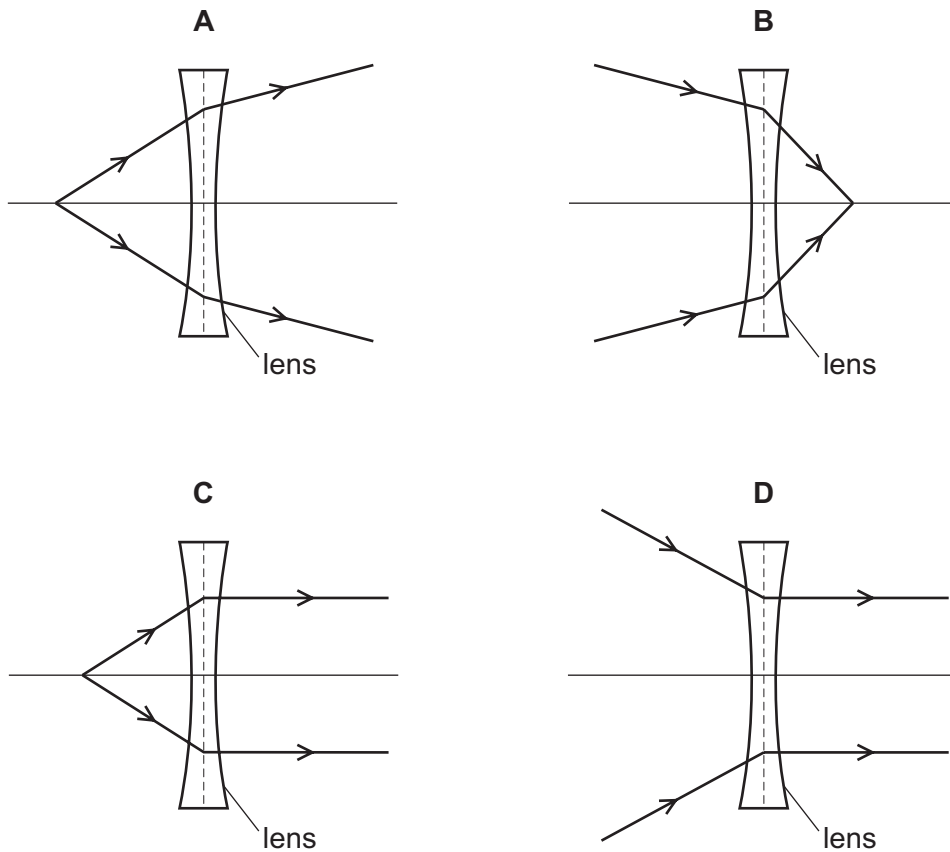

26 Many devices produce electromagnetic waves when operating.

Which device produces electromagnetic waves of the highest frequency?

- A mobile phone
- B sunbed
- C television controller
- D toaster

27 Which two frequencies are both outside the range of audible frequencies for a healthy human ear?

- A 2.0 Hz and 500 Hz
- B 2.0 Hz and 25 kHz
- C 25 Hz and 25 kHz
- D 500 Hz and 25 kHz

28 Sound waves are displayed as a trace on the screen of an oscilloscope.

Which trace shows a sound that becomes quieter with a higher pitch?

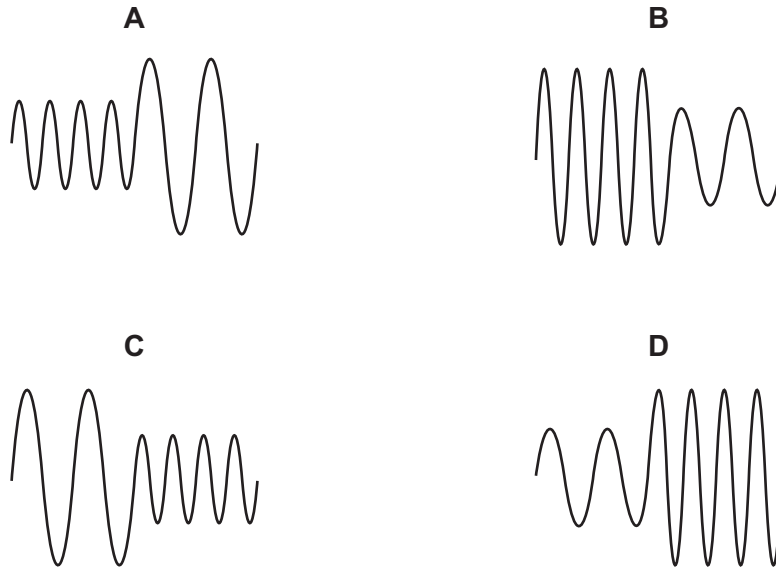

29 The N pole of a permanent magnet is placed in turn close to a piece of iron, the S pole of another magnet, and a piece of copper.

Which objects are attracted to the N pole of the permanent magnet?

	piece of iron	S pole	piece of copper
A	✓	✓	x
B	x	✓	x
C	x	✓	✓
D	x	x	✓

key

✓ = attracted

x = not attracted

- 30 Four plotting compasses are placed near a bar magnet. Ignore any effects of the Earth's magnetic field.

One compass appears like this .

What is a possible position for this compass?

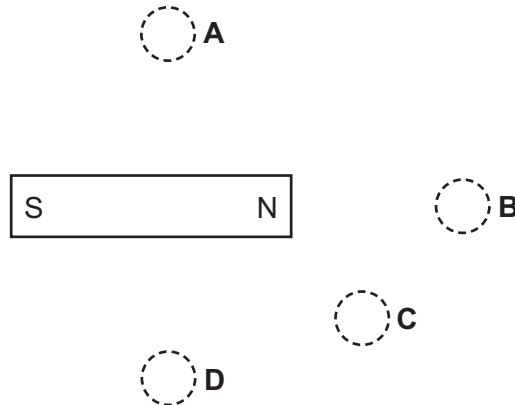

- 31 Two oppositely charged plastic rods are placed next to each other.

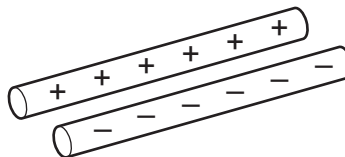

Which row describes and explains how the rods move?

	movement	explanation
A	away from each other	opposite charges attract
B	away from each other	opposite charges repel
C	towards each other	opposite charges attract
D	towards each other	opposite charges repel

- 32 A meter that measures the rate of flow of charge in a resistor is placed in a circuit.

What is the name of this meter and how is it connected to the resistor?

	name	connection
A	ammeter	in parallel
B	ammeter	in series
C	voltmeter	in parallel
D	voltmeter	in series

33 Which device is used to convert electrical energy to kinetic energy?

- A iron
- B kettle
- C lamp
- D motor

34 Why is a fuse used in an electrical appliance?

- A to earth the appliance
- B to protect the appliance
- C to change the power of the appliance
- D to change the voltage supplied to the appliance

35 A coil of wire is rotated at a constant rate between the poles of a U-shaped magnet.

The two ends of the coil are connected to different slip rings.

Which graph shows how the voltage V between the slip rings varies with time t ?

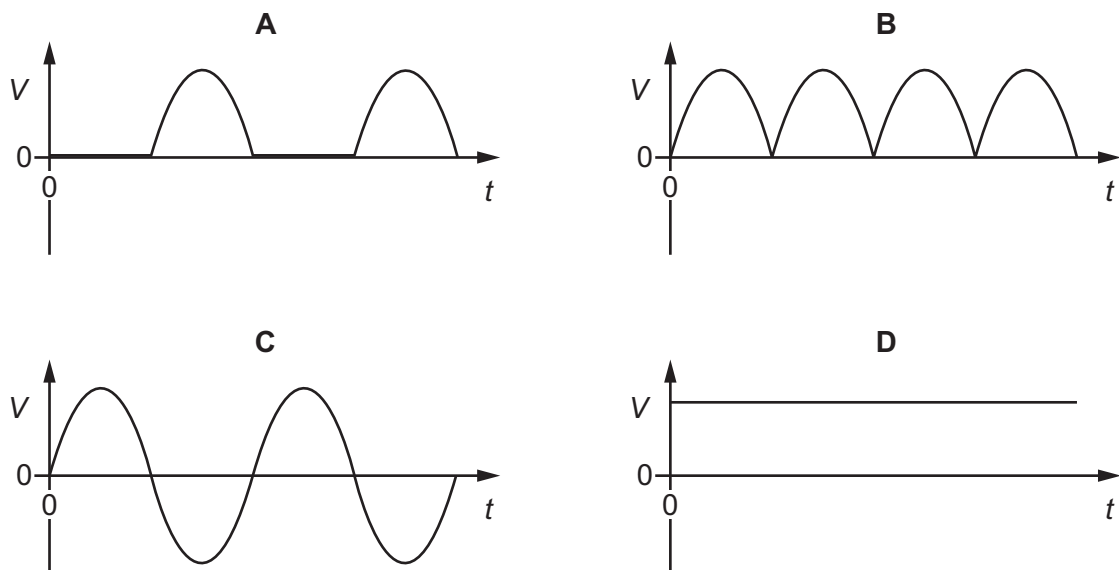

36 Which statement about a transformer is correct?

- A The changing magnetic field in the transformer induces an e.m.f. in the secondary coil.
- B The core of the transformer is made of iron because iron is a good electrical conductor.
- C The transformer converts alternating current to direct current.
- D The transformer converts direct current to alternating current.

- 37 Three types of radiation emitted by unstable nuclei are helium nuclei, short wavelength electromagnetic waves and electrons.

What are these three types of radiation?

	helium nuclei	electromagnetic waves	electrons
A	alpha	gamma	beta
B	beta	gamma	alpha
C	gamma	alpha	beta
D	gamma	beta	alpha

- 38 The diagram shows a relay used to switch on an electric motor.

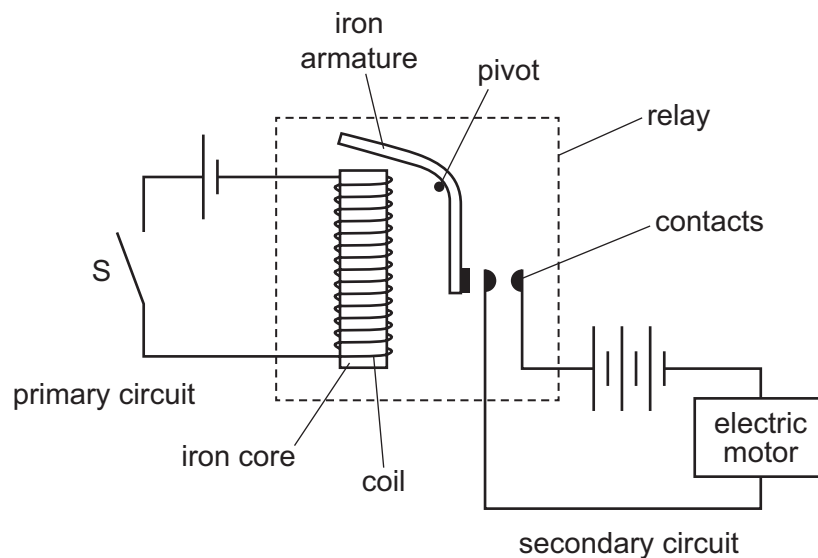

A student makes five statements to explain how the relay switches on the electric motor. The statements are **not** in the correct order.

- 1 The current in the coil magnetises the electromagnet.
- 2 The armature closes the contacts.
- 3 The current in the secondary circuit makes the motor turn.
- 4 The electromagnet attracts the iron armature.
- 5 The switch S in the primary circuit is closed.

What is the correct order of the statements?

- A** 1 → 5 → 2 → 4 → 3
- B** 3 → 2 → 4 → 1 → 5
- C** 3 → 4 → 1 → 5 → 2
- D** 5 → 1 → 4 → 2 → 3

39 Different radioactive emissions have different characteristics.

A student lists the following characteristics for an alpha-particle.

characteristic P It has a positive charge.

characteristic Q It has a high penetrating ability.

characteristic R It is a component of the electromagnetic spectrum.

Which characteristics are correct?

A P only

B R only

C P and Q

D Q and R

40 A wooden object is believed to be 6000 years old.

Which isotope, found in the object, is used to determine the age of the object?

A ^{12}C

B ^{13}C

C ^{14}C

D ^{15}C

Permission to reproduce items where third-party owned material protected by copyright is included has been sought and cleared where possible. Every reasonable effort has been made by the publisher (UCLES) to trace copyright holders, but if any items requiring clearance have unwittingly been included, the publisher will be pleased to make amends at the earliest possible opportunity.

To avoid the issue of disclosure of answer-related information to candidates, all copyright acknowledgements are reproduced online in the Cambridge Assessment International Education Copyright Acknowledgements Booklet. This is produced for each series of examinations and is freely available to download at www.cambridgeinternational.org after the live examination series.

Cambridge Assessment International Education is part of Cambridge Assessment. Cambridge Assessment is the brand name of the University of Cambridge Local Examinations Syndicate (UCLES), which is a department of the University of Cambridge.