



Cambridge O Level

PHYSICS

5054/11

Paper 1 Multiple Choice

October/November 2020

1 hour

You must answer on the multiple choice answer sheet.

You will need: Multiple choice answer sheet
Soft clean eraser
Soft pencil (type B or HB is recommended)

INSTRUCTIONS

- There are **forty** questions on this paper. Answer **all** questions.
- For each question there are four possible answers **A, B, C** and **D**. Choose the **one** you consider correct and record your choice in soft pencil on the multiple choice answer sheet.
- Follow the instructions on the multiple choice answer sheet.
- Write in soft pencil.
- Write your name, centre number and candidate number on the multiple choice answer sheet in the spaces provided unless this has been done for you.
- Do **not** use correction fluid.
- Do **not** write on any bar codes.
- You may use a calculator.

INFORMATION

- The total mark for this paper is 40.
- Each correct answer will score one mark. A mark will not be deducted for a wrong answer.
- Any rough working should be done on this question paper.

This document has **16** pages. Blank pages are indicated.



- 1 A heavy nail is fixed firmly to a wall. It is pulled by a string at 40° to the vertical. The nail does not move.

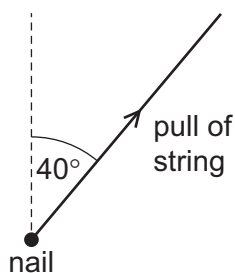

Three forces act on the nail:

- its weight W ,
- the tension T in the string,
- the force R exerted by the wall.

Which diagram, drawn to scale, represents the three forces?

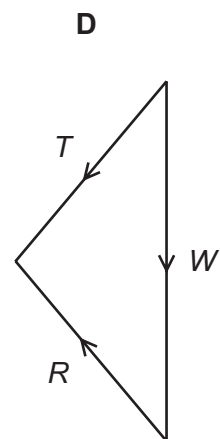
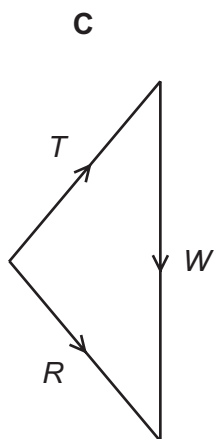
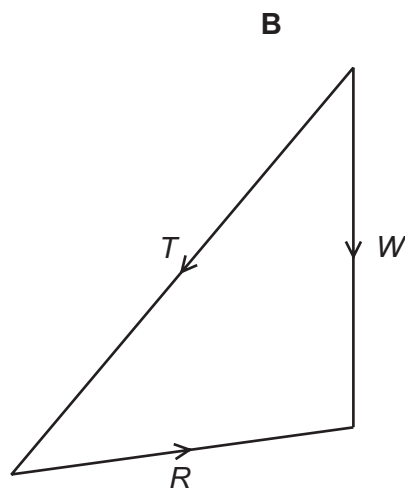
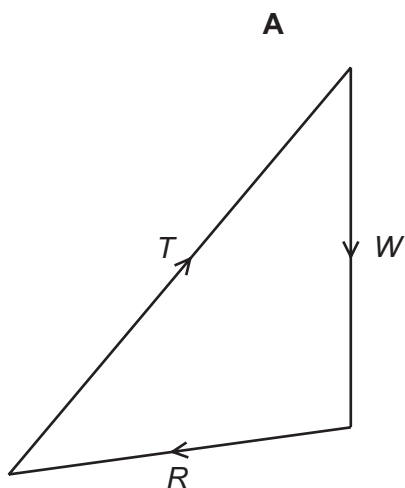

- 2 A car begins to move. It speeds up until it reaches a constant speed. It continues to travel at this constant speed for the rest of the journey.

What happens to the acceleration and what happens to the velocity of the car during the journey?

- A Both the acceleration and the velocity change.
- B Only the acceleration changes.
- C Only the velocity changes.
- D Neither the acceleration nor the velocity changes.

- 3 A car of mass 800 kg has a forward acceleration of 2.5 m/s^2 . A frictional force of 1200 N opposes the motion of the car.

What is the driving force due to the engine of the car?

- A 800 N B 1200 N C 2000 N D 3200 N

- 4 A parachutist falling at a steady speed opens her parachute.

Which row is correct for the direction of the resultant force and for the direction of the acceleration of the parachutist just after her parachute opens?

	resultant force direction	acceleration direction
A	downwards	downwards
B	downwards	upwards
C	upwards	downwards
D	upwards	upwards

- 5 Some gas trapped in a cylinder is compressed at constant temperature by a piston.

Which property of the gas does **not** change?

- A density
- B mass
- C pressure
- D volume

- 6 A block is hung on a spring balance. The marker inside the balance is pulled down by the block.

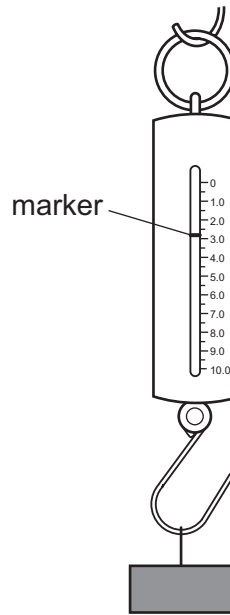

What can the position of the marker be used to determine?

- A the mass of the block in kg
 - B the mass of the block in N
 - C the moment caused by the block in N
 - D the weight of the block in kg
- 7 An electrically charged plastic ball is at rest.
- Which types of field are caused by the ball?
- A electric, gravitational and magnetic
 - B electric and gravitational only
 - C electric and magnetic only
 - D gravitational and magnetic only
- 8 Which statement about mass and weight is correct?
- A Mass is a scientific term that means the same as weight.
 - B The mass of an object on Earth is 10 times its weight.
 - C Weight is a scalar quantity, mass is a vector quantity.
 - D Weight is the force of gravity pulling on a mass.

9 Which expression is used to calculate density?

- A mass \times volume
- B $\frac{\text{mass}}{\text{volume}}$
- C volume + mass
- D $\frac{\text{volume}}{\text{mass}}$

10 A length of thread is attached to a lamina at point P, as shown in the diagram.

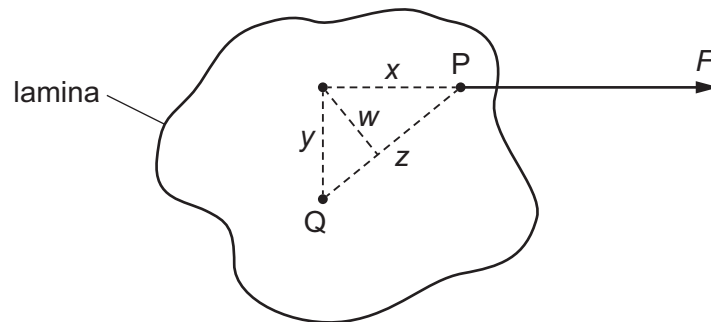

The lamina is free to rotate about point Q.

The tension in the thread is F .

What is the moment of F about Q?

- A Fw B Fx C Fy D Fz
- 11 Which list contains only quantities that can be changed by a force?
- A mass, shape, velocity
 - B mass, shape, volume
 - C mass, velocity, volume
 - D shape, velocity, volume

12 An extension–load graph is plotted for a spring.

Which point marks the limit of proportionality for this spring?

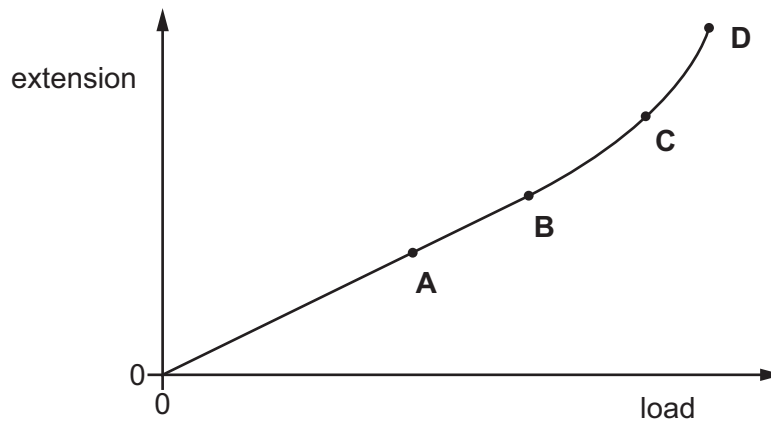

13 A mercury manometer is used to measure the pressure of a gas.

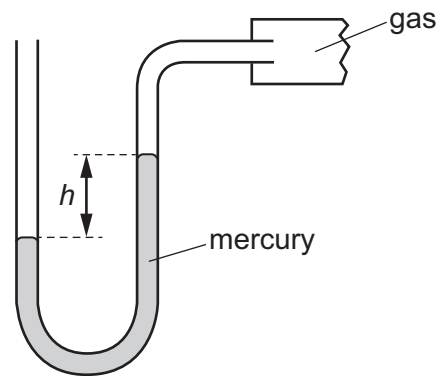

The pressure of the atmosphere is p_0 and the density of mercury is ρ .

What is the pressure of the gas?

- A** $p_0 - h\rho g$ **B** $p_0 + h\rho g$ **C** p_0 **D** $h\rho g$

14 There is a current in a resistor.

Which energy transfer takes place?

- A** electrical \rightarrow chemical
B electrical \rightarrow internal
C kinetic \rightarrow electrical
D potential \rightarrow electrical

15 A ball is dropped from a height as shown.

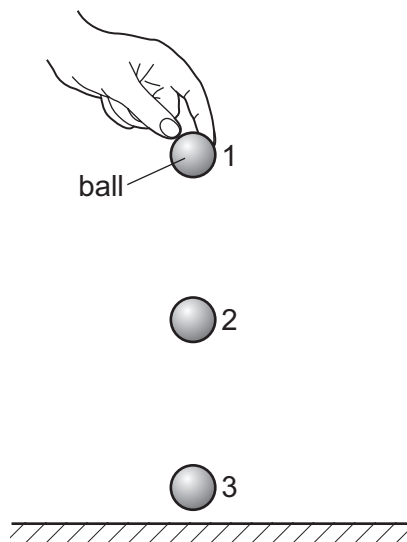

Ignoring the effects of air resistance, which statement about the total energy of the ball is correct?

- A It is the same at all points.
 - B It is greatest at point 1.
 - C It is greatest at point 2.
 - D It is greatest at point 3.
- 16 Which source of electrical energy is **not** renewable?
- A solar cells
 - B hydroelectric generators
 - C wind turbines
 - D nuclear reactors
- 17 The table shows some data from a high-jump competition.

Which athlete jumps the highest?

	weight / N	increase in gravitational potential energy / J
A	600	1320
B	700	1610
C	800	1760
D	900	1800

- 18 A workman rolls a barrel of weight 2000 N up a plank of length 2.0 m and onto a lorry. The back of the lorry is 0.80 m above the horizontal surface of the road.

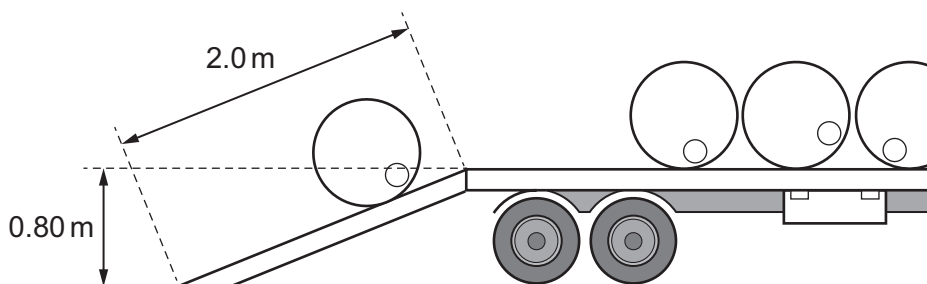

What is the work done on the barrel against gravity?

- A 1000 J B 1600 J C 2500 J D 4000 J
- 19 Data for three types of electricity generator are shown.

	input energy /MJ	wasted energy /MJ
oil	500	300
nuclear	200	160
hydroelectric	10	1.0

Which is the least efficient generator and which is the most efficient?

	least efficient	most efficient
A	hydroelectric	nuclear
B	hydroelectric	oil
C	nuclear	hydroelectric
D	oil	hydroelectric

- 20 An instruction in a physics book states 'divide the length between two marks on the glass tube into 100 equal parts'.

What is being described?

- A how to calculate weight using the extension of a spring
 B how to calibrate a thermometer
 C how to determine pressure with a manometer
 D how to measure volume with a measuring cylinder
- 21 What is a unit for heat capacity?

- A J B J/g C J/°C D J/(g°C)

22 A block of aluminium is heated.

What happens to the kinetic energy and to the potential energy of the molecules?

	kinetic energy	potential energy
A	increase	increase
B	increase	decrease
C	decrease	increase
D	decrease	decrease

23 Which statement about the melting of ice and the boiling of water is correct?

- A** Both processes are accompanied by a decrease in volume.
- B** Both processes involve energy transfer and a temperature change.
- C** Both processes involve the absorption of latent heat.
- D** Both processes result in the increase of intermolecular forces.

24 A substance has a melting point of -17°C and a boiling point of 117°C .

In which state does the substance exist at -10°C and at 110°C ?

	at -10°C	at 110°C
A	solid	liquid
B	solid	gas
C	liquid	liquid
D	liquid	gas

- 25 A smoke particle Z is seen to move randomly when suspended in air as illustrated.

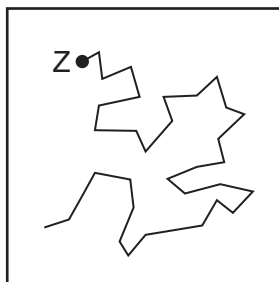

Which statement explains why Z moves randomly?

- A** Air molecules are much larger than Z.
B Air molecules are smaller than Z.
C Air molecules hit Z from different directions.
D Air molecules vibrate about a fixed position.
- 26 An electromagnetic wave has a speed of 3.0×10^8 m/s and a wavelength of 10 cm.

What is the frequency of the wave?

- A** 3.3×10^{-10} Hz
B 3.3×10^{-8} Hz
C 3.0×10^7 Hz
D 3.0×10^9 Hz
- 27 Three objects P, Q and R are placed in front of a plane mirror.

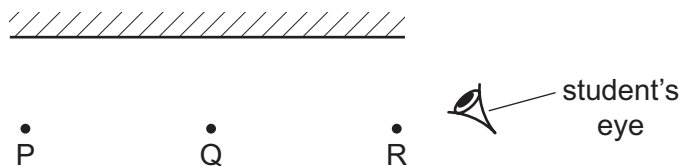

The student's eye is positioned as shown.

Which of the images of P, Q and R can the student see in the mirror?

	P	Q	R	
A	✓	✓	✓	key
B	✓	✓	x	✓ = can see
C	✓	x	x	x = cannot see
D	x	x	x	

28 A ray of light R is incident on a water-to-air surface with an angle of incidence θ .

The angle θ is less than the critical angle c .

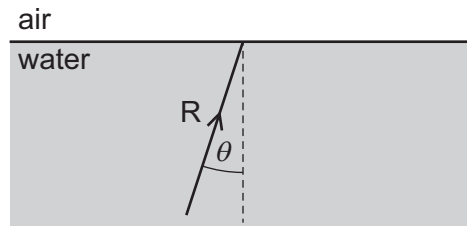

Which statement describes the subsequent path of R?

- A It travels back into the water with an angle of reflection equal to c .
- B It travels back into the water with an angle of reflection greater than c .
- C It travels into air with an angle of refraction greater than θ .
- D It travels into air with an angle of refraction smaller than θ .

29 A parallel beam of light is incident on a thin converging lens.

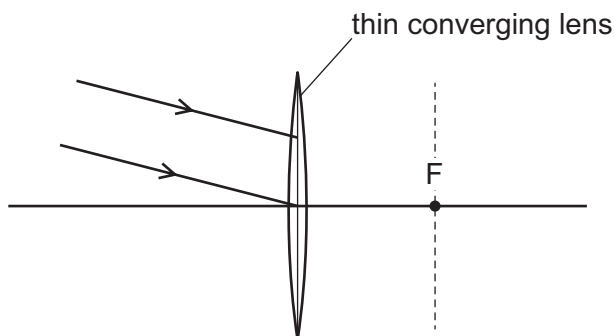

F is one focal point of the lens.

Which ray diagram shows the light after it has passed through the lens?

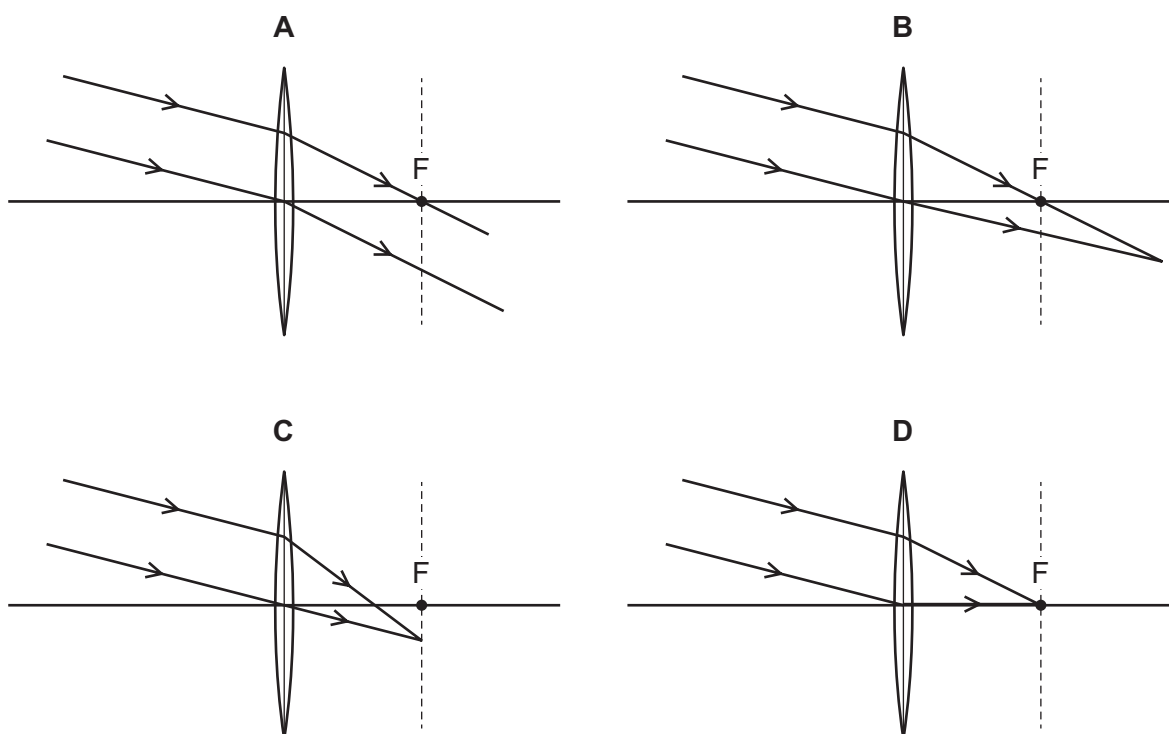

30 Which description of a sound wave is correct?

- A a longitudinal electromagnetic wave
- B a transverse electromagnetic wave
- C an oscillation of particles parallel to the direction of travel of the wave energy
- D an oscillation of particles perpendicular to the direction of travel of the wave energy

31 Where does sound travel the fastest?

- A in a vacuum
- B in gases
- C in liquids
- D in solids

32 A bar magnet is placed in a hollow iron cylinder. The diagram shows the magnetic field pattern produced.

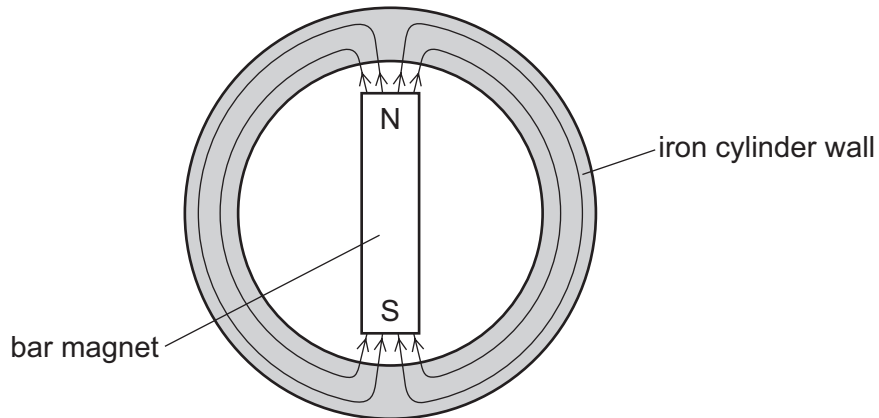

What is the cause of the field inside the cylinder wall?

- A electromagnetic generation
- B electromagnetic induction
- C electrostatic induction
- D magnetic induction

- 33** A polythene rod is brought near to a stream of water from a metal tap which is earthed. Tap water is an electrical conductor.

The water moves towards the rod, as shown.

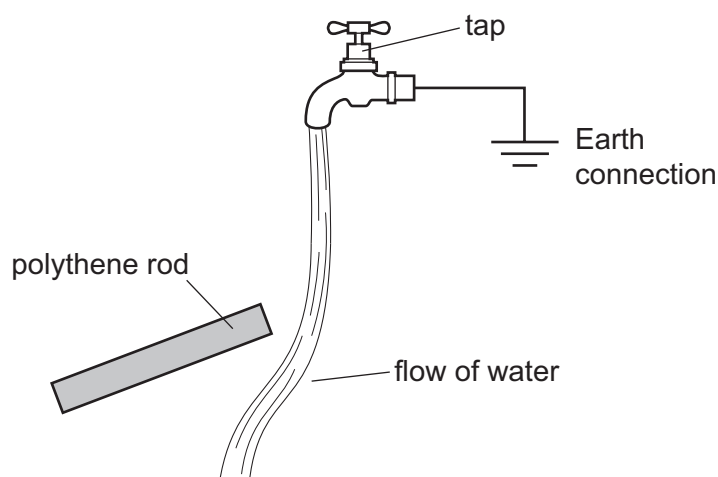

Which description of the rod and water is correct?

	rod	water
A	charged	charged
B	charged	uncharged
C	uncharged	charged
D	uncharged	uncharged

- 34** A small negative charge is placed at a point where an electric field is vertically upwards.

There is a force on the charge due to the field.

In which direction does it act?

- A** vertically upwards
- B** vertically downwards
- C** horizontally to the right
- D** horizontally to the left

- 35 In the circuit shown, the resistance of resistor Y is four times greater than the resistance of resistor X.

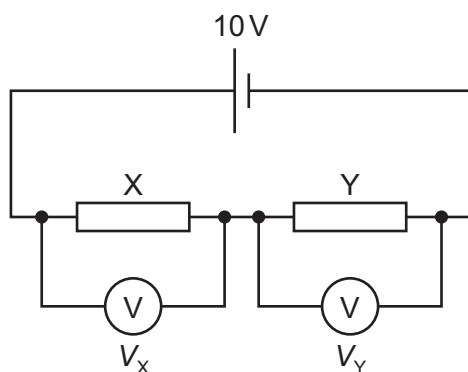

What is the difference $V_Y - V_X$ of the voltages shown on the voltmeters?

- A** 2.0V **B** 5.0V **C** 6.0V **D** 8.0V
- 36 Two identical resistors connected in parallel have a total resistance of 4.0Ω .
What is the total resistance when the same two resistors are connected in series?
- A** 1.0Ω **B** 4.0Ω **C** 8.0Ω **D** 16Ω
- 37 Three identical lamps and three ammeters are connected as shown.

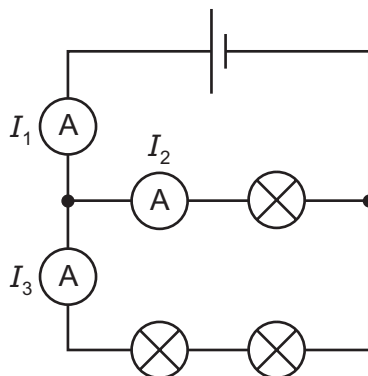

The readings on the ammeters are I_1 , I_2 and I_3 .

How are the readings related?

- A** $I_1 = I_2 = I_3$
B $I_1 > I_2$ and $I_2 = I_3$
C $I_1 > I_3 > I_2$
D $I_1 > I_2 > I_3$

- 38 A thermistor and a light-dependent resistor (LDR) are connected in series. A potential difference (p.d.) of 6.0 V is applied across them as shown.

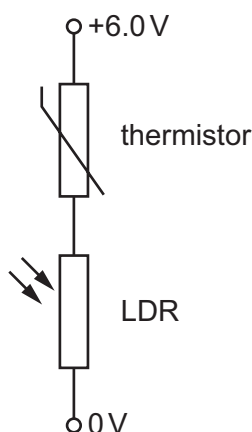

The thermistor has a resistance of $6000\ \Omega$ in a cold room and $1000\ \Omega$ in a warm room. The LDR has a resistance of $2000\ \Omega$ in dim light and $500\ \Omega$ in bright light.

When is the p.d. across the LDR equal to 2.0 V?

- A** in a cold room with bright light
B in a cold room with dim light
C in a warm room with bright light
D in a warm room with dim light
- 39 A student calculates the amount of energy used by an electric heater.
- What is the equation for calculating the energy E in kWh?
- A** $E = I \text{ (ampere)} \times V \text{ (volt)} \times t \text{ (second)}$
B $E = I \text{ (ampere)} \times V \text{ (volt)} \times t \text{ (hour)}$
C $E = I \text{ (ampere)} \times V \text{ (volt)} \times t \text{ (second)} \div 1000$
D $E = I \text{ (ampere)} \times V \text{ (volt)} \times t \text{ (hour)} \div 1000$
- 40 An isotope P is radioactive and has a half-life of 7.0 years. A sample initially contains 0.016 kg of P.

After how long will the sample contain 0.0020 kg of P?

- A** 7.0 years **B** 14 years **C** 21 years **D** 28 years

Permission to reproduce items where third-party owned material protected by copyright is included has been sought and cleared where possible. Every reasonable effort has been made by the publisher (UCLES) to trace copyright holders, but if any items requiring clearance have unwittingly been included, the publisher will be pleased to make amends at the earliest possible opportunity.

To avoid the issue of disclosure of answer-related information to candidates, all copyright acknowledgements are reproduced online in the Cambridge Assessment International Education Copyright Acknowledgements Booklet. This is produced for each series of examinations and is freely available to download at www.cambridgeinternational.org after the live examination series.

Cambridge Assessment International Education is part of the Cambridge Assessment Group. Cambridge Assessment is the brand name of the University of Cambridge Local Examinations Syndicate (UCLES), which itself is a department of the University of Cambridge.