



Cambridge International Examinations
Cambridge Ordinary Level

PHYSICS

5054/12

Paper 1 Multiple Choice

October/November 2018

1 hour

Additional Materials: Multiple Choice Answer Sheet
Soft clean eraser
Soft pencil (type B or HB is recommended)

* 6 1 5 7 9 0 8 5 4 0 *

READ THESE INSTRUCTIONS FIRST

Write in soft pencil.

Do not use staples, paper clips, glue or correction fluid.

Write your name, Centre number and candidate number on the Answer Sheet in the spaces provided unless this has been done for you.

DO NOT WRITE IN ANY BARCODES.

There are **forty** questions on this paper. Answer **all** questions. For each question there are four possible answers **A, B, C** and **D**.

Choose the **one** you consider correct and record your choice in **soft pencil** on the separate Answer Sheet.

Read the instructions on the Answer Sheet very carefully.

Each correct answer will score one mark. A mark will not be deducted for a wrong answer.

Any rough working should be done in this booklet.

Electronic calculators may be used.

This document consists of **15** printed pages and **1** blank page.

- 1 An apple falls from a tree.

Which row describes the forces acting on the apple and the motion of the apple as it falls?

	forces acting on the apple	motion of the apple
A	balanced	acceleration
B	balanced	constant speed
C	unbalanced	acceleration
D	unbalanced	constant speed

- 2 The table shows how the speeds of four bodies, **A**, **B**, **C** and **D**, change with time.

Which body has an acceleration that is **not** constant?

time/s	speed of A m/s	speed of B m/s	speed of C m/s	speed of D m/s
0	0	0	0	5.5
1	1.0	2.0	3.0	6.5
2	3.0	4.0	6.0	7.5
3	6.0	6.0	9.0	8.5

- 3 An engine pulls a truck at constant speed on a level track.

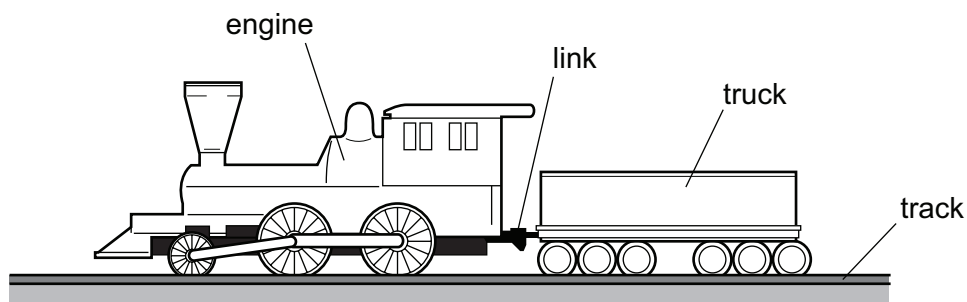

The link between the engine and the truck breaks. The driving force on the engine remains constant.

What effect does this have on the engine and on the truck?

	engine	truck
A	speed stays constant	slows down
B	speeds up	slows down
C	speed stays constant	stops immediately
D	speeds up	stops immediately

- 4 On which car is there a resultant force?
- A a car moving along a straight horizontal road at constant speed
 - B a car moving around a bend at constant speed
 - C a car moving uphill at constant velocity
 - D a car that is stationary
- 5 Which piece of apparatus may be used to compare the masses of two objects?
- A balance
 - B manometer
 - C measuring cylinder
 - D micrometer
- 6 The graph shows how the extension of a spring changes with the masses suspended from it when the spring is on planet X and when the spring is on planet Y.

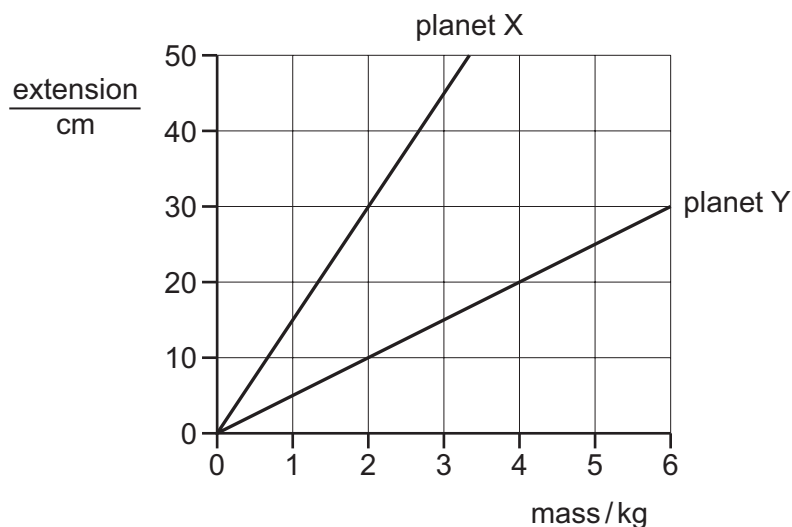

Which conclusion can be drawn from these graphs?

- A It is not possible to compare the gravitational field strengths on planets X and Y.
- B The gravitational field strength on planet X is equal to the gravitational field strength on planet Y.
- C The gravitational field strength on planet X is one third of the gravitational field strength on planet Y.
- D The gravitational field strength on planet X is three times the gravitational field strength on planet Y.

- 7 Two cylinders P and Q are made of copper.

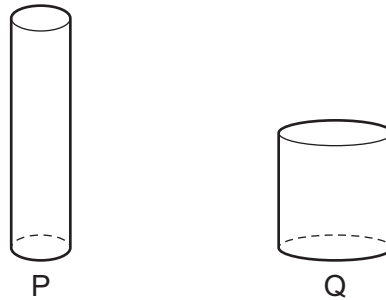

The height of P is twice the height of Q. The diameter of P is half the diameter of Q.

Which statement is correct?

- A The density of cylinder P is four times that of cylinder Q.
 - B The density of cylinder P is twice that of cylinder Q.
 - C The density of cylinder P is equal to that of cylinder Q.
 - D The density of cylinder P is half that of cylinder Q.
- 8 A tennis ball is compressed. Work is done and energy is transferred to the molecules of air inside the ball, and also to the rubber from which the ball is made.

Which row is correct?

	kinetic energy of air molecules inside the ball	temperature of ball
A	decreases	decreases
B	decreases	increases
C	increases	decreases
D	increases	increases

- 9 Paths are laid as shown between points X, Y and Z.

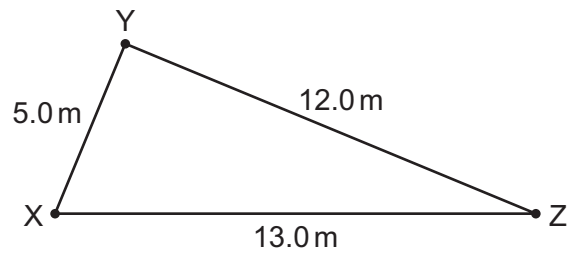

A person walks along the paths from X to Y to Z and then back to X.

What is the value of the total displacement and of the total distance travelled?

	total displacement /m	total distance travelled /m
A	0	0
B	0	30
C	30	0
D	30	30

- 10 Which diagram shows the addition of the 4.0 N and the 3.0 N forces?

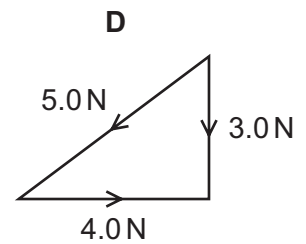
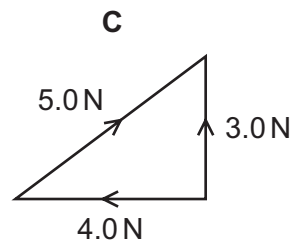
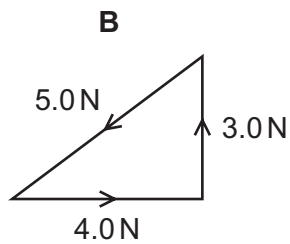
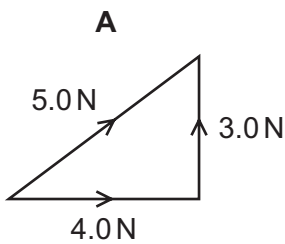

11 The diagram represents a geothermal power station.

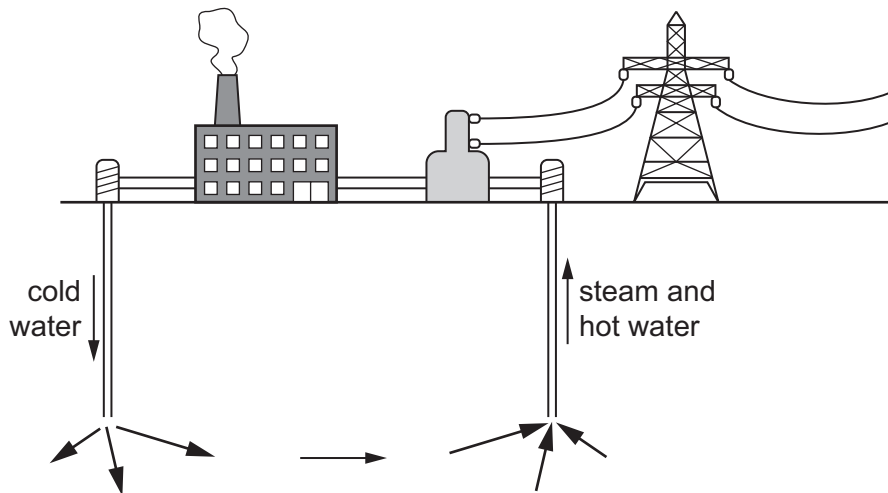

Which useful energy transformation is taking place?

- A electrical energy \rightarrow potential energy
- B electrical energy \rightarrow thermal energy
- C potential energy \rightarrow electrical energy
- D thermal energy \rightarrow electrical energy

12 A motor is used to lift a load 0.50 m vertically, as shown.

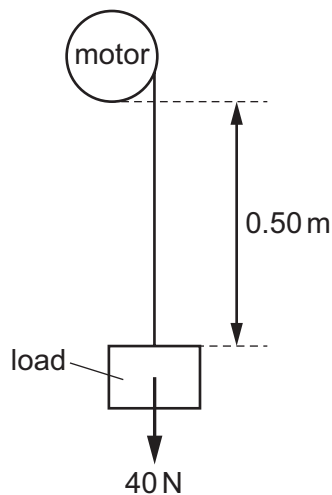

The load weighs 40 N. The power of the motor is 20 W and the system is 25% efficient.

How long does it take to raise the load?

- A 0.040 s
- B 0.25 s
- C 4.0 s
- D 40 s

- 13 Different liquids are poured into four different containers.

In which container does the liquid produce the greatest pressure at the bottom of the container?

	area of base /cm ²	density of liquid g/cm ³	depth of liquid /cm
A	10	1.3	50
B	20	0.80	80
C	40	1.0	60
D	50	0.92	75

- 14 A rectangular block of metal has weight 6.0 N and measures 3.0 cm × 4.0 cm × 5.0 cm.

What is the smallest pressure that it can exert when resting on a horizontal surface?

- A** 0.10 N/cm² **B** 0.30 N/cm² **C** 0.40 N/cm² **D** 0.50 N/cm²
- 15 Air is trapped in a cylinder by a piston. The pressure of the air is p and the length of the air column is 20 cm.

The piston is moved outwards until the length of the air column has increased by 40 cm.

The temperature of the air remains constant.

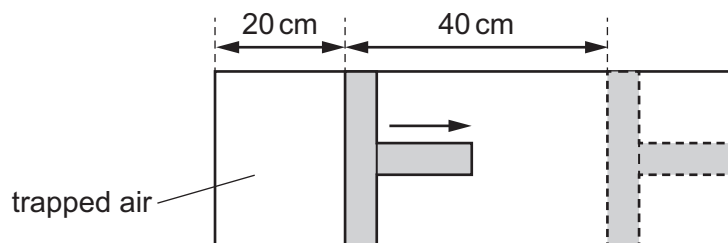

What is the new air pressure?

- A** $\frac{p}{2}$ **B** $\frac{p}{3}$ **C** $2p$ **D** $3p$

- 16 A long tube, full of mercury, is inverted in a small dish of mercury.

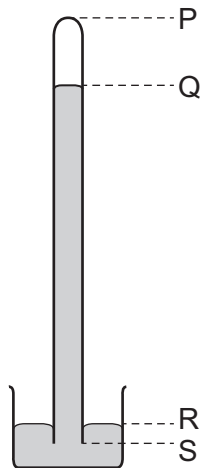

The mercury level in the tube falls, leaving a vacuum at the top.

When the atmospheric pressure decreases, which length decreases?

- A** PQ **B** PS **C** QR **D** RS
- 17 A cold bottle containing a drink is placed on a table on a warm day. Drops of water form on the outside of the bottle.

Which process causes the drops to form?

- A** condensation
B conduction
C convection
D evaporation
- 18 Some gas is trapped in a closed container. The gas is cooled and the volume of the container is kept constant.
- What happens to the gas molecules?
- A** They collide with the walls more often.
B They contract.
C They get closer together.
D They move more slowly.

19 A 100 g piece of solid lead at room temperature is heated. After 22 s, it has all become liquid.

The graph shows how its temperature varies with time.

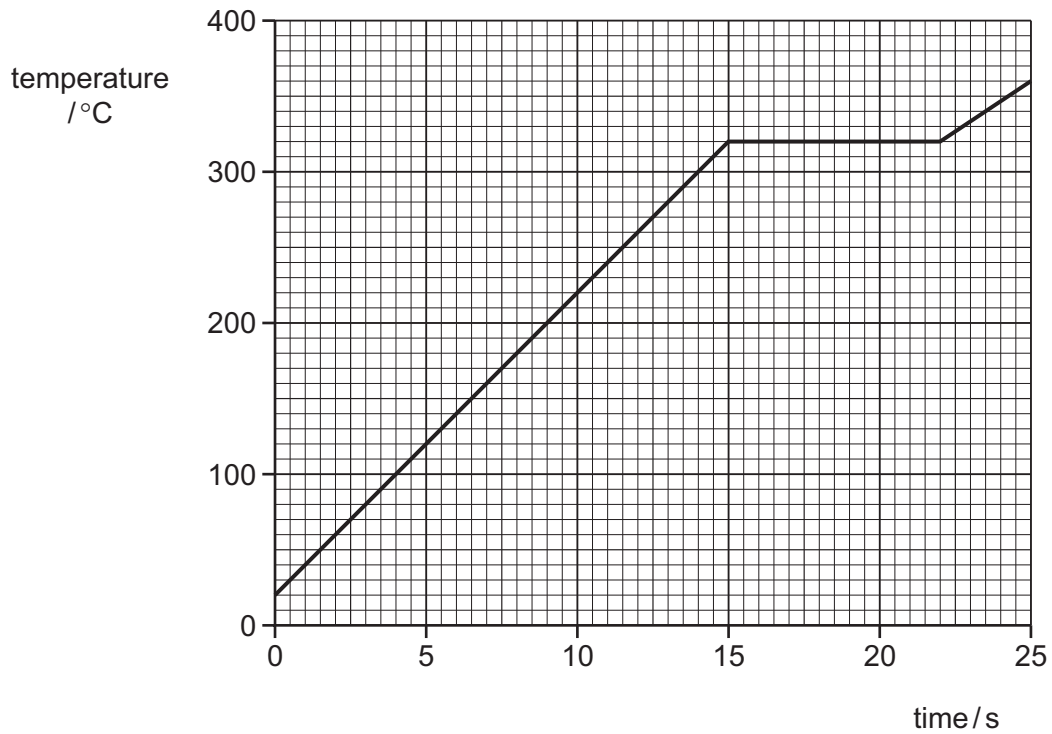

The power of the heater is 320 W.

Which expression gives the specific latent heat, in J/kg, of the lead?

- A** $\frac{7.0 \times 320}{0.10 \times 300}$
 B $\frac{22 \times 320}{0.10 \times 300}$
 C $\frac{7.0 \times 320}{0.10}$
 D $\frac{22 \times 320}{0.10}$

20 What increases when a liquid becomes a gas at its boiling point?

- A** the average kinetic energy of the molecules
B the molecular size
C the molecular spacing
D the total number of molecules

- 21 Two liquid-in-glass thermometers are almost identical. They contain the same quantity of the same liquid and the diameters of their capillary tubes are the same.

The only difference is that one thermometer is longer than the other.

Which row shows how the ranges and the sensitivities of the thermometers compare?

	ranges	sensitivities
A	different	different
B	different	same
C	same	different
D	same	same

- 22 Which statement about a water wave is correct?

- A** The amplitude is the vertical distance between a trough and a peak.
- B** The frequency is the number of troughs passing a point in one second added to the number of peaks passing a point in one second.
- C** The speed is the horizontal distance travelled per second by a peak.
- D** The wavelength is the horizontal distance between a trough and a peak.

- 23 The diagram shows a thin converging lens of focal length f .

Where must an object be placed to produce a real image in the position shown?

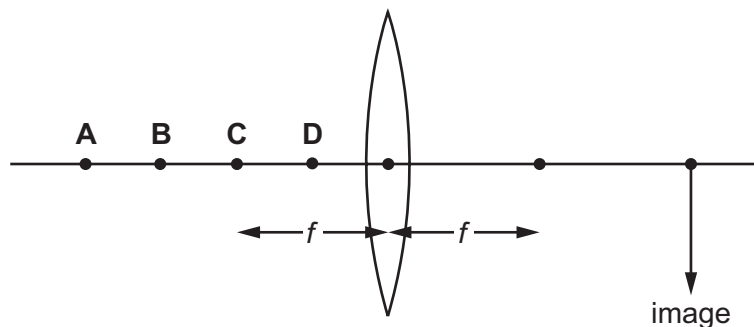

- 24 White light is dispersed by a prism. Compared with blue light, the **red** light is

- A** slowed down less and refracted less.
- B** slowed down less and refracted more.
- C** slowed down more and refracted less.
- D** slowed down more and refracted more.

25 A student reads the following in her physics book.

‘The incident angle is greater than 42° which is the critical angle for glass in air.’

What is the student reading about?

- A focal length of a glass lens
- B reflection in a plane mirror
- C refraction as light enters glass
- D total internal reflection

26 Which statement about radio waves is correct?

- A Radio waves are sound waves.
- B Radio waves are used to kill cancerous cells.
- C Radio waves are used in television communications.
- D Radio waves have frequencies higher than those of visible light.

27 Ultrasound is used to map the ocean floor.

During one survey, the depth of water is 1200 m. An ultrasound pulse is sent from the surface and when it returns to the ship, another pulse is sent immediately. In any period of 8.0 s, five pulses are sent down from the surface.

What is the speed of the ultrasound in water?

- A 150 m/s
- B 300 m/s
- C 750 m/s
- D 1500 m/s

28 Which diagram shows the magnetic field pattern in the region between the N-poles of the two bar magnets?

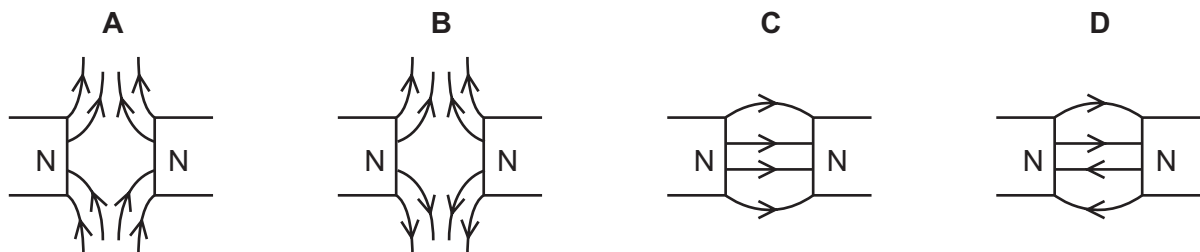

29 Students are asked to describe an experiment to measure the resistance of a metallic conductor.

Which description is correct?

- A** Connect an ammeter in parallel and a voltmeter in series with the conductor then use $R = \frac{I}{V}$.
- B** Connect an ammeter in parallel and a voltmeter in series with the conductor then use $R = \frac{V}{I}$.
- C** Connect a voltmeter in parallel and an ammeter in series with the conductor then use $R = \frac{I}{V}$.
- D** Connect a voltmeter in parallel and an ammeter in series with the conductor then use $R = \frac{V}{I}$.

30 The diagram shows three $6.0\ \Omega$ resistors connected to give various total resistances.

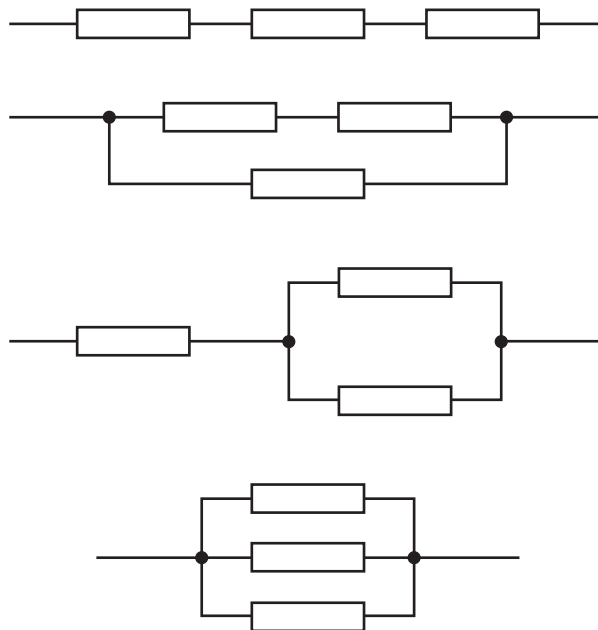

What is the difference between the smallest total resistance and the largest total resistance?

- A** $7.0\ \Omega$ **B** $9.0\ \Omega$ **C** $12\ \Omega$ **D** $16\ \Omega$

31 A wire of length $0.50\ \text{m}$ and cross-sectional area $1.0 \times 10^{-6}\ \text{m}^2$ has a resistance of $0.75\ \Omega$.

Another wire of the same material has a length of $2.0\ \text{m}$ and a cross-sectional area of $0.50 \times 10^{-6}\ \text{m}^2$.

What is the resistance of the longer wire?

- A** $0.094\ \Omega$ **B** $0.38\ \Omega$ **C** $1.5\ \Omega$ **D** $6.0\ \Omega$

- 32** A defibrillator is a device that is used to give an electric shock to a patient's heart.
It supplies an electric shock with energy 240 J at an average voltage of 2000 V for 10 ms.
What is the average current it supplies?
- A** 0.012 A **B** 1.2 A **C** 12 A **D** 120 A
- 33** In a lighting circuit, the switch is placed in the live wire.
Why is this?
- A** A lamp in the circuit can be isolated from the supply.
B The fuse is in the neutral wire.
C The switch does not work in the neutral wire.
D Too much current flows in the earth wire.
- 34** Which cable transmits electrical energy at the highest voltage?
- A** a cable from a bicycle dynamo to a lamp
B a household lighting cable
C a power cable between towns
D an electric cooker cable

35 A thermistor and a light-dependent resistor are connected in series.

Which conditions give the least resistance?

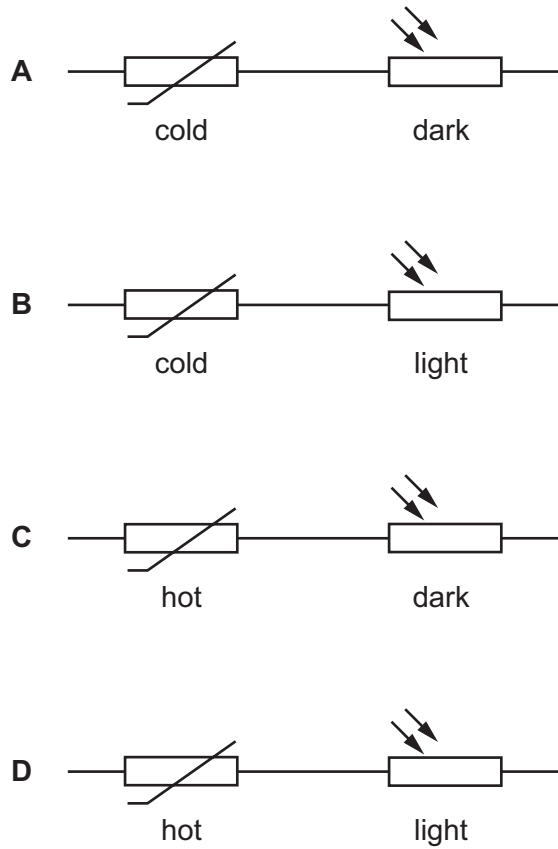

36 An oscilloscope is connected to a d.c. power supply.

The time-base on the oscilloscope is switched off.

What is seen on the screen of the oscilloscope?

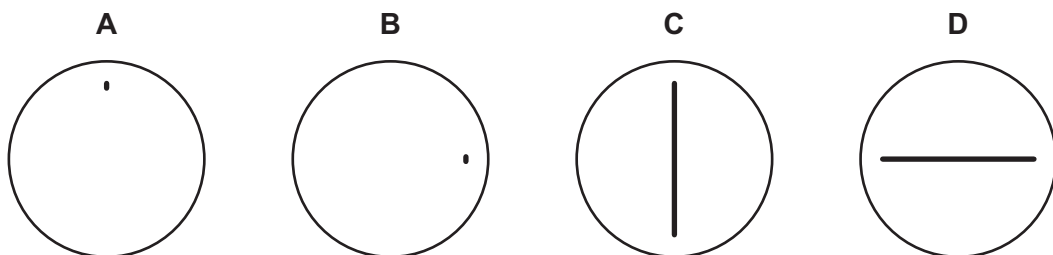

37 What does the alpha-radiation given off by radioactive nuclei consist of?

- A** fast-moving protons
- B** helium nuclei
- C** microwaves
- D** radio waves

- 38** Which statement about the reactor in a nuclear power station is correct?
- A** In the reactor, the main reaction occurs when protons hit uranium nuclei.
 - B** The process taking place in the reactor is called nuclear fusion.
 - C** The reactor produces energy to boil water and to produce steam.
 - D** Carbon dioxide is the major waste product from the reactor.
- 39** The results of the alpha-particle scattering experiment gave evidence for which of the following?
- A** nuclear fusion
 - B** radioactive decay
 - C** the existence of isotopes
 - D** the nuclear atom
- 40** Which statement about two different isotopes of the same element is correct?
- A** Both isotopes have the same number of electrons in a nucleus.
 - B** Both isotopes have the same number of protons in a nucleus.
 - C** Both isotopes have the same number of neutrons in a nucleus.
 - D** Both isotopes have the same number of nucleons in a nucleus.

BLANK PAGE

Permission to reproduce items where third-party owned material protected by copyright is included has been sought and cleared where possible. Every reasonable effort has been made by the publisher (UCLES) to trace copyright holders, but if any items requiring clearance have unwittingly been included, the publisher will be pleased to make amends at the earliest possible opportunity.

To avoid the issue of disclosure of answer-related information to candidates, all copyright acknowledgements are reproduced online in the Cambridge International Examinations Copyright Acknowledgements Booklet. This is produced for each series of examinations and is freely available to download at www.cie.org.uk after the live examination series.

Cambridge International Examinations is part of the Cambridge Assessment Group. Cambridge Assessment is the brand name of University of Cambridge Local Examinations Syndicate (UCLES), which is itself a department of the University of Cambridge.