

CAMBRIDGE INTERNATIONAL EXAMINATIONS
General Certificate of Education Ordinary Level

PHYSICS

5054/01

Paper 1 Multiple Choice

October/November 2003

1 hour

Additional Materials: Multiple Choice Answer Sheet
Soft clean eraser
Soft pencil (type B or HB is recommended)

READ THESE INSTRUCTIONS FIRST

Write in soft pencil.

Do not use staples, paper clips, highlighters, glue or correction fluid.

Write your name, Centre number and candidate number on the Answer Sheet in the spaces provided unless this has been done for you.

There are **forty** questions on this paper. Answer **all** questions. For each question there are four possible answers **A, B, C, and D**.

Choose the **one** you consider correct and record your choice in **soft pencil** on the separate Answer Sheet.

Read the instructions on the Answer Sheet very carefully.

Each correct answer will score one mark. A mark will not be deducted for a wrong answer.
Any rough working should be done in this booklet.

This document consists of **18** printed pages and **2** blank pages.

- 1 One oscillation of a swinging pendulum occurs when the bob moves from **X** to **Y** and back to **X** again.

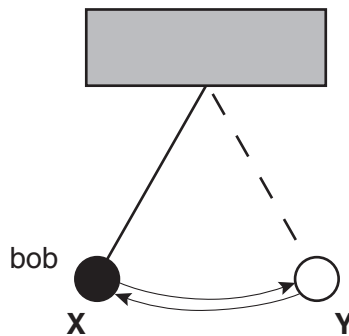

Using a stopwatch, which would be the most accurate way to measure the time for one oscillation of the pendulum?

- A Time 20 oscillations and multiply by 20.
B Time 20 oscillations and divide by 20.
C Time one oscillation.
D Time the motion from **X** to **Y**, and double it.
- 2 Which of the following **defines** acceleration?

- A $\frac{\text{change in velocity}}{\text{time taken}}$
B $\frac{\text{change in speed}}{\text{time taken}}$
C $\frac{\text{change in distance}}{\text{time taken}}$
D $\frac{\text{change in distance in a fixed direction}}{\text{time taken}}$

- 3 The graph shows the movement of a car over a period of 50 s.

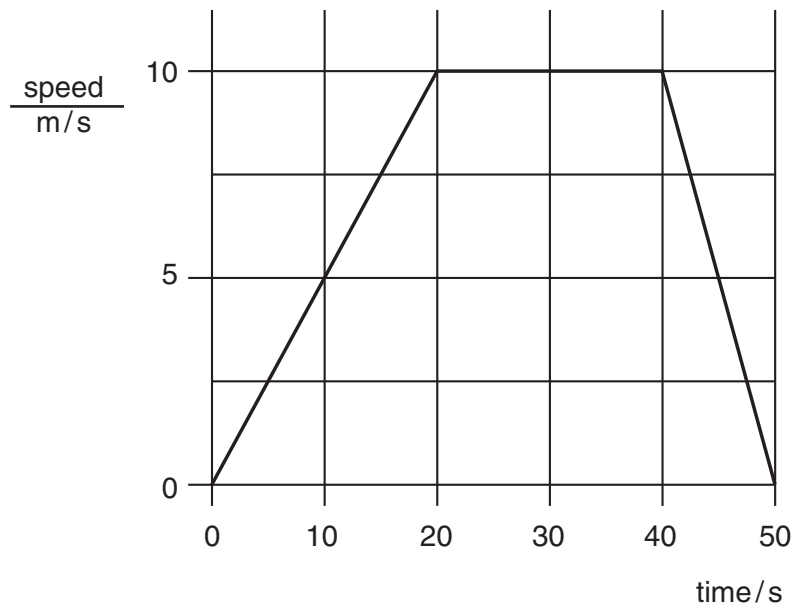

What was the distance travelled by the car during the time when it was moving at a steady speed?

- A 10 m
- B 100 m
- C 200 m
- D 400 m

4 The diagram shows a cyclist leaning over in order to cycle around a corner.

Which force is necessary to maintain the motion around the corner?

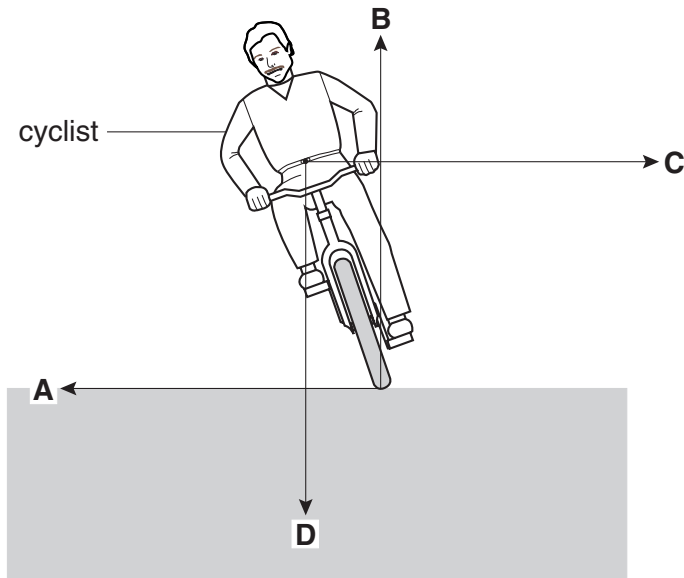

5 A box **X** full of large granite rocks is weighed. An identical box **Y** full of small granite chippings is then weighed.

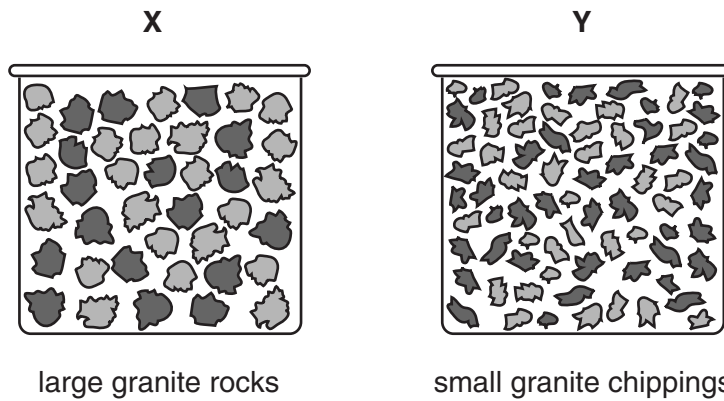

Which box weighs more and why?

	heavier box	reason
A	X	there is more air in box X
B	X	the density of a chipping is less than a rock
C	Y	there is less air in box Y
D	Y	the density of a chipping is greater than a rock

6 Which property of a body **cannot** be changed if a force is applied to it?

- A its mass
- B its shape
- C its size
- D its velocity

7 Which diagram correctly shows the addition of a 4 N and a 3 N force?

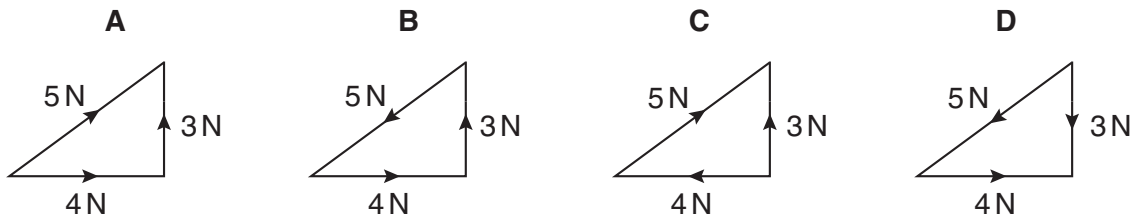

8 A student who weighs 500 N climbs up a flight of stairs 10 metres high in 5 seconds.

What power does she develop?

- A $500 \times 10 \times 5 \text{ W}$
- B $\frac{500 \times 10}{5} \text{ W}$
- C $\frac{500 \times 5}{10} \text{ W}$
- D $\frac{5}{500 \times 10} \text{ W}$

9 A rock of mass 20 kg is travelling in space at a speed of 6 m/s.

What is its kinetic energy?

- A 60 J
- B 120 J
- C 360 J
- D 720 J

- 10 The diagrams show, to the same scale, the vertical sections of a set of circular vessels, each containing the same depth of water.

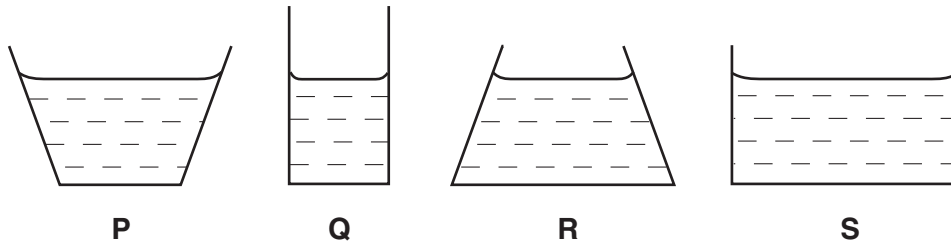

Which one of the following statements is correct?

- A The water exerts the greatest pressure on the base of vessel **P**.
 B The water exerts the greatest pressure on the base of vessel **S**.
 C The water exerts the same force on the base of each vessel.
 D The water exerts the same pressure on the base of each vessel.
- 11 Which graph shows the relationship between the pressure and volume of a fixed mass of gas at constant temperature?

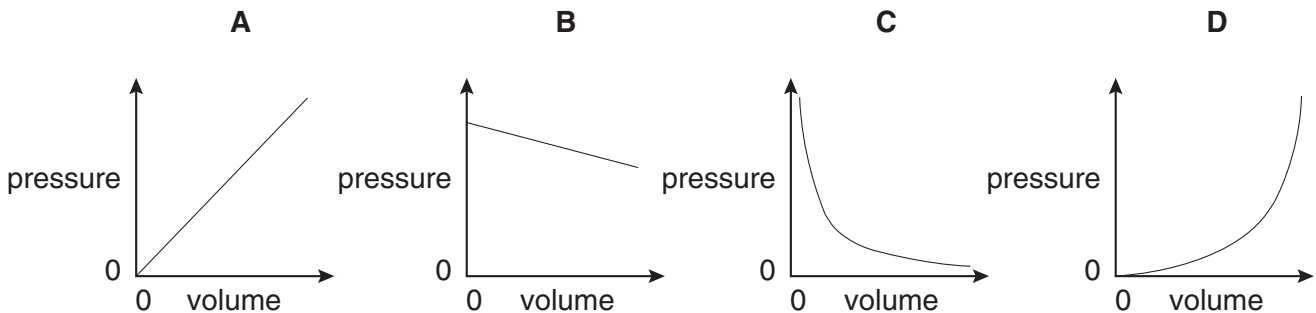

- 12 Assuming the temperature remains constant, which combination correctly describes the volume and the shape of a gas or liquid?

	gas or liquid	volume	shape
A	gas	fixed	not fixed
B	gas	not fixed	not fixed
C	liquid	fixed	fixed
D	liquid	not fixed	fixed

- 13 An axle is too large to fit into the hole in a wheel that is made of the same metal.

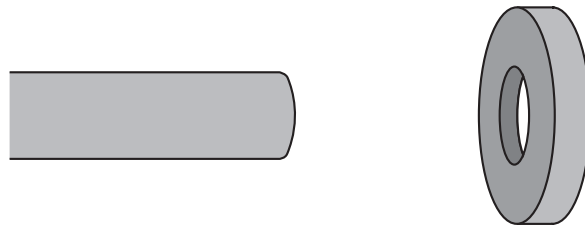

How can the axle be made to fit into the hole?

- A by cooling the axle alone
 - B by cooling the wheel alone
 - C by cooling both the axle and the wheel
 - D by heating both the axle and the wheel
- 14 A 2 kg mass of copper is heated for 40 s by a heater that produces 100 J/s.

The specific heat capacity of copper is 400 J/(kg K).

What is the rise in temperature?

- A 5 K
 - B 10 K
 - C 20 K
 - D 50 K
- 15 In a vacuum flask, which methods of heat transfer are prevented by the vacuum?
- A conduction only
 - B convection only
 - C conduction and convection only
 - D conduction, convection and radiation

16 The diagram shows the variation of the displacement of a wave with distance from the source.

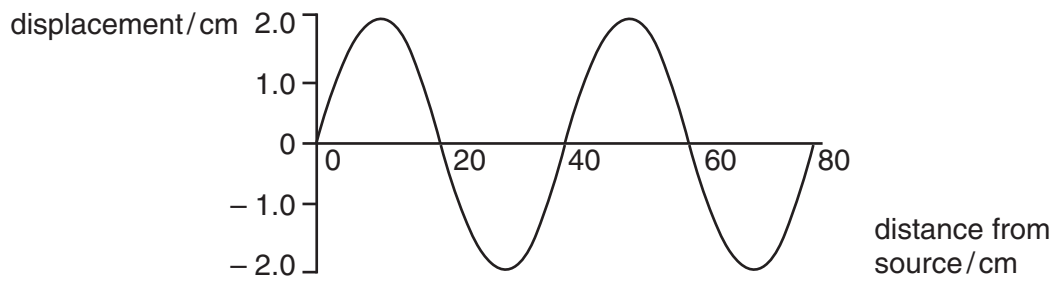

What is the amplitude of the wave?

- A 2.0 cm
- B 4.0 cm
- C 20 cm
- D 40 cm

17 A ray of red light enters a semi-circular glass block normal to the curved surface.

Which of the following correctly shows the partial reflection and refraction of the ray?

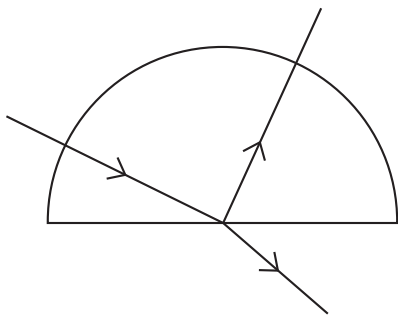

A

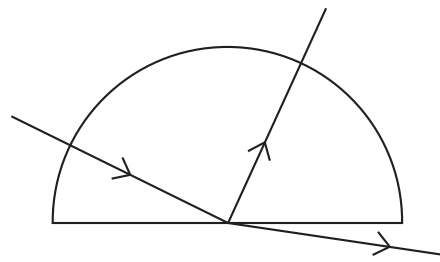

B

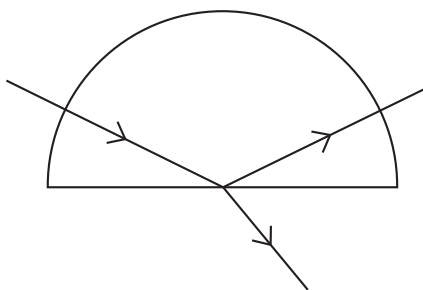

C

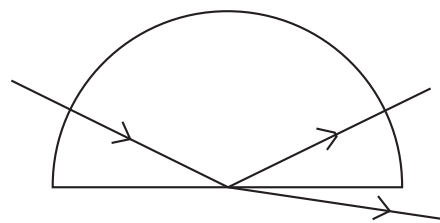

D

- 18 The diagram shows two divergent rays of light from an object **O** being reflected from a plane mirror.

At which position will the image be formed?

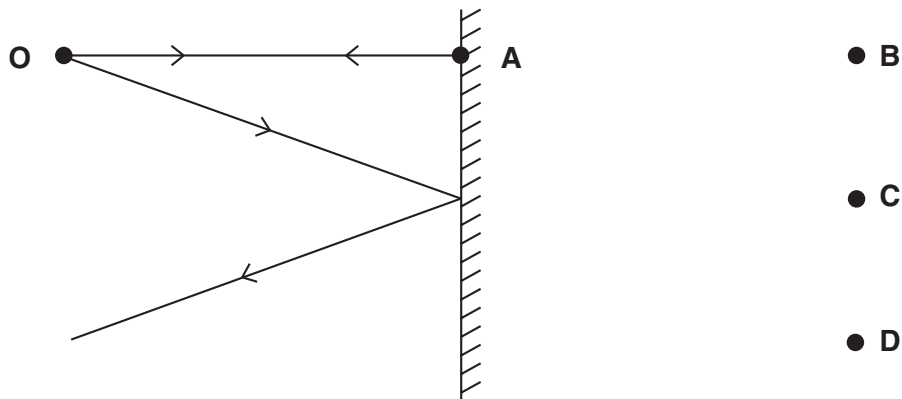

- 19 The human eye has a converging lens system that produces an image at the back of the eye.

If the eye views a distant object, which type of image is produced?

- A real, erect, same size
 - B real, inverted, diminished
 - C virtual, erect, diminished
 - D virtual, inverted, magnified
- 20 Which of the following does **not** produce a sound wave?
- A a bell ringing under water
 - B a gun fired in a room with no echoes
 - C a hammer hitting a block of rubber
 - D an explosion in outer space
- 21 Which of the following will prove that a metal bar is a permanent magnet?
- A it attracts another magnet
 - B it attracts both ends of a compass needle
 - C it conducts electricity
 - D it repels another magnet

22 Four metal rods are placed, in turn, inside a coil of copper wire.

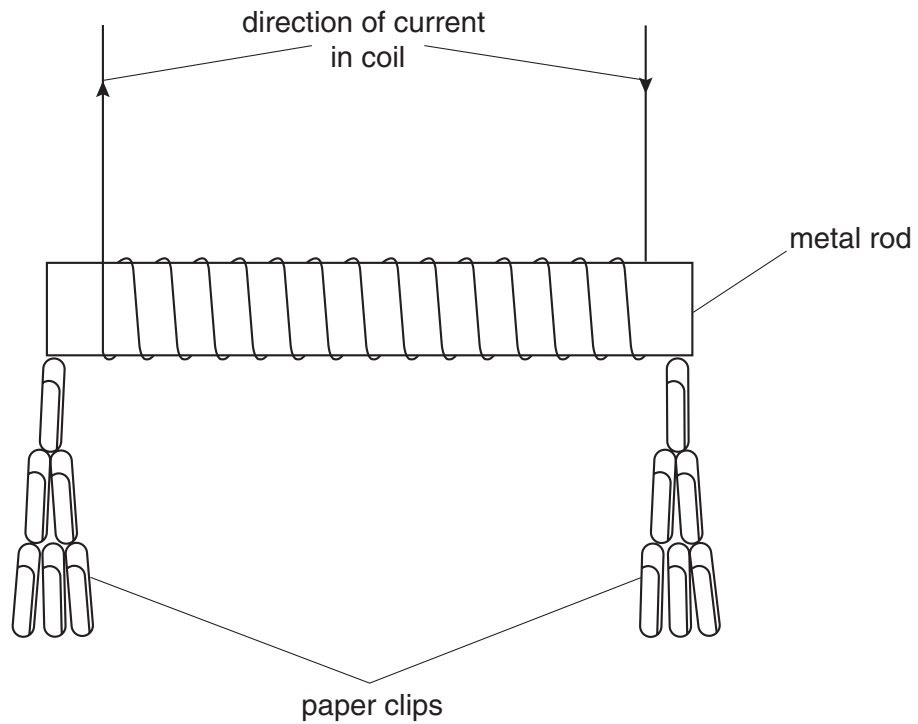

The table below gives the results of the experiment.

Which rod would be the most suitable to use for the core of a coil in a circuit breaker?

metal rod	number of paper clips picked up when there is a current in the coil	number of paper clips still attracted when the current is switched off
A	1	0
B	20	2
C	35	0
D	35	30

23 A positively charged rod is brought close to an insulated metal sphere.

Which diagram best shows the induced charges on the sphere?

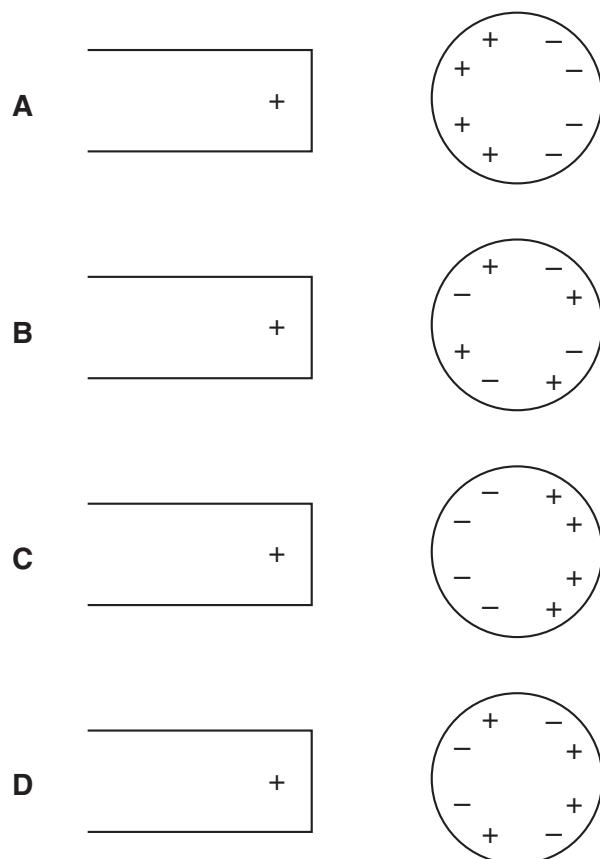

24 How could the unit of potential difference, the volt, also be written?

- A** A/s
- B** C/A
- C** C/J
- D** J/C

25 X and Y are lamps with filaments made from the same material.

The filament of lamp X is thicker and shorter than that of lamp Y.

When connected to the mains and switched on, which is the brighter lamp and which lamp has the larger resistance?

	brighter lamp	larger resistance
A	X	X
B	X	Y
C	Y	X
D	Y	Y

26 Diagram 1 shows a resistor connected to a battery, an ammeter and a voltmeter.

The ammeter reading is 0.5 A and the voltmeter reading is 3.0 V.

A second identical resistor is now connected in parallel with the first resistor, as shown in diagram 2.

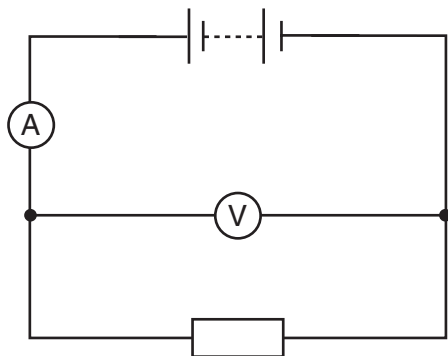

diagram 1

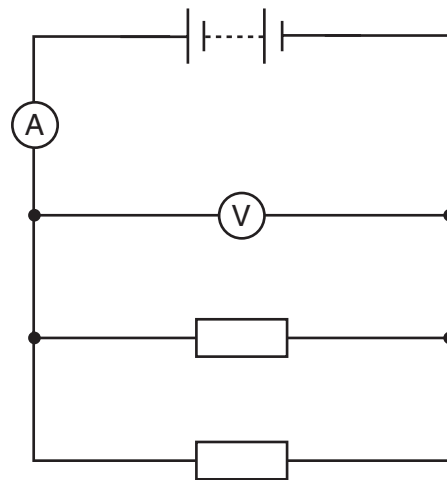

diagram 2

What are the ammeter and voltmeter readings in the circuit shown in diagram 2?

	ammeter reading / A	voltmeter reading / V
A	0.5	3.0
B	0.5	6.0
C	1.0	1.5
D	1.0	3.0

- 27 A $1.0\ \Omega$ resistor and a $2.0\ \Omega$ resistor are connected in series across a 12 V d.c. supply.

What is the current in the circuit?

- A 0.25 A
 - B 4.0 A
 - C 6.0 A
 - D 12 A
- 28 The cable to an electric fan becomes so worn that the live wire makes electrical contact with the metal case. The case is earthed. The plug to the fan contains a 5 A fuse. There is a current of 4 A when the fan works normally.

What will happen?

- A The current will run to earth and the fuse will not be affected.
 - B The fuse will melt and switch off the circuit.
 - C The metal case will become live and dangerous.
 - D The metal case will become very hot.
- 29 A small heater operates at 12 V, 2 A.
- How much energy will it use when it is run for 5 minutes?
- A 30 J
 - B 120 J
 - C 1800 J
 - D 7200 J
- 30 Which of the following has **no** effect on the size of the turning effect on the coil of an electric motor?

- A the size of the current in the coil
- B the direction of the current in the coil
- C the number of turns in the coil
- D the strength of the magnetic field

- 31 The diagram shows a beam of electrons entering a magnetic field. The direction of the magnetic field is out of the page.

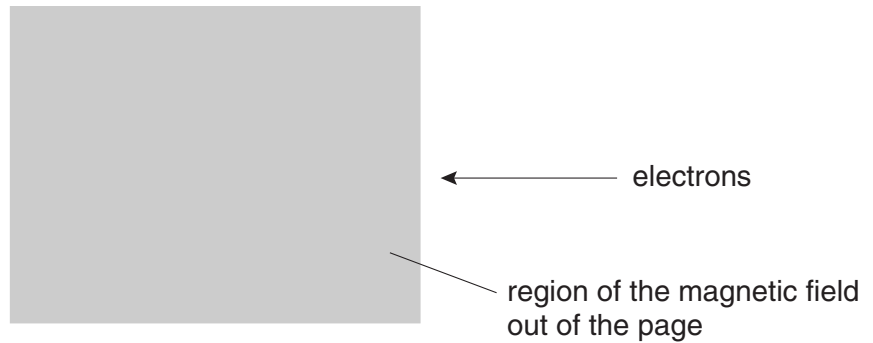

In which direction does the deflection of the electrons occur?

- A into the page
 B out of the page
 C towards the bottom of the page
 D towards the top of the page
- 32 Why is electricity transmitted along power lines at very high voltages?
- A to reduce the resistance of the cables
 B so that transformers can be used
 C to make sure that the current is the same all the way along the power lines
 D to reduce loss of energy
- 33 A small coil is connected to a galvanometer as shown below. When the magnet is allowed to fall towards the coil, the galvanometer pointer gives a momentary deflection to the right of the zero position.

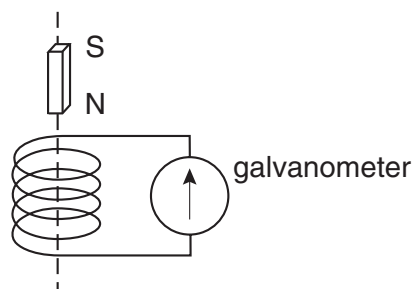

The magnet moves through the coil and, as it falls away from the coil, the galvanometer pointer

- A gives a continuous reading to the left.
 B gives a momentary deflection to the left.
 C gives a momentary deflection to the right.
 D gives a continuous reading to the right.

34 A simple a.c. generator produces a voltage that varies with time as shown.

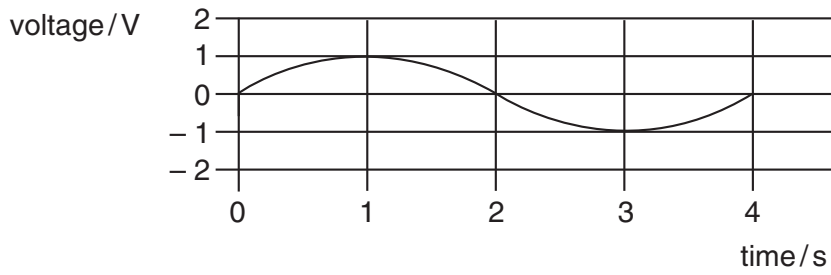

Which graph shows how the voltage varies with time when the generator rotates at twice the original speed?

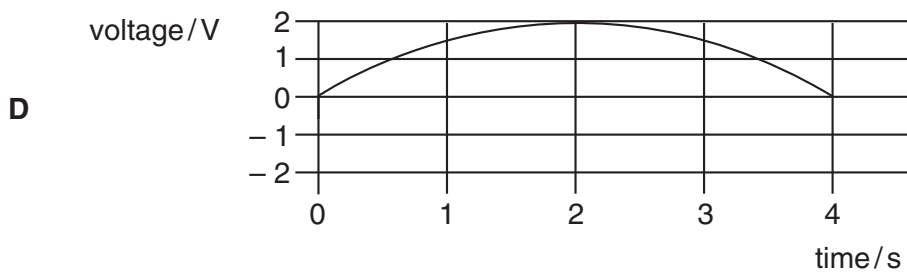
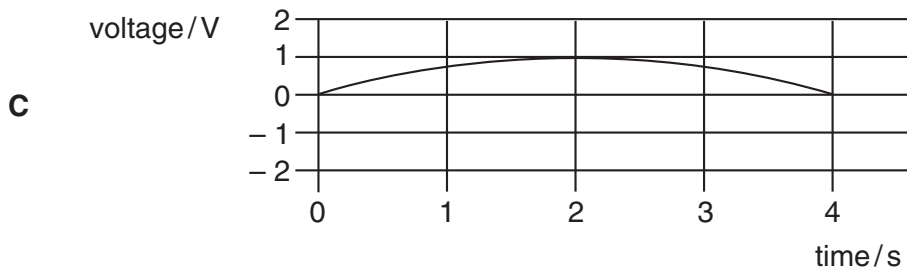
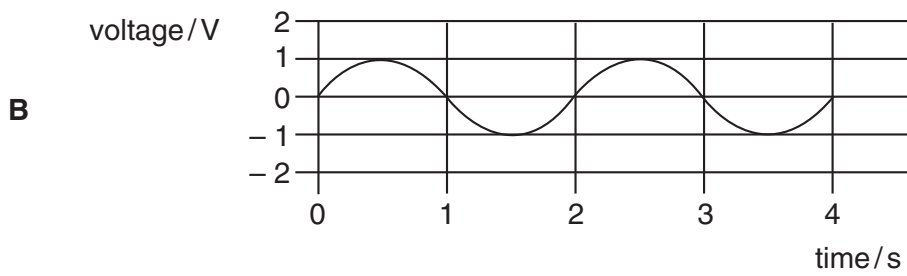
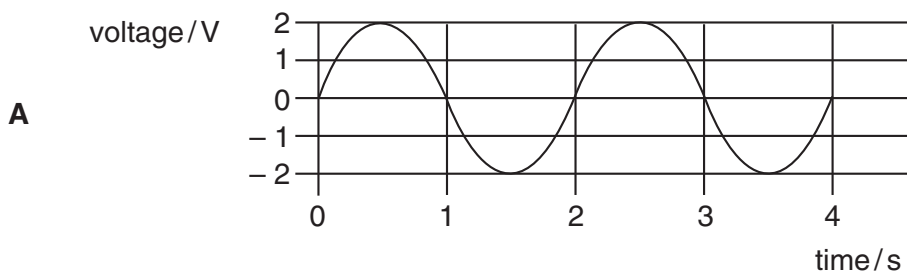

35 The diagram shows a circuit.

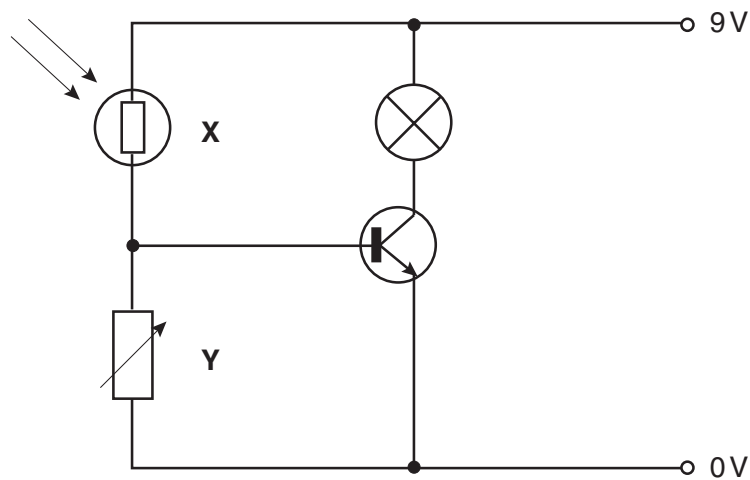

What are the components X and Y?

	X	Y
A	fuse	resistor
B	lamp	variable resistor
C	light-dependent resistor	light-emitting diode
D	light-dependent resistor	variable resistor

36 The following trace is shown on the screen of an oscilloscope when it is connected to a transformer. The scale is set at 5 V per centimetre.

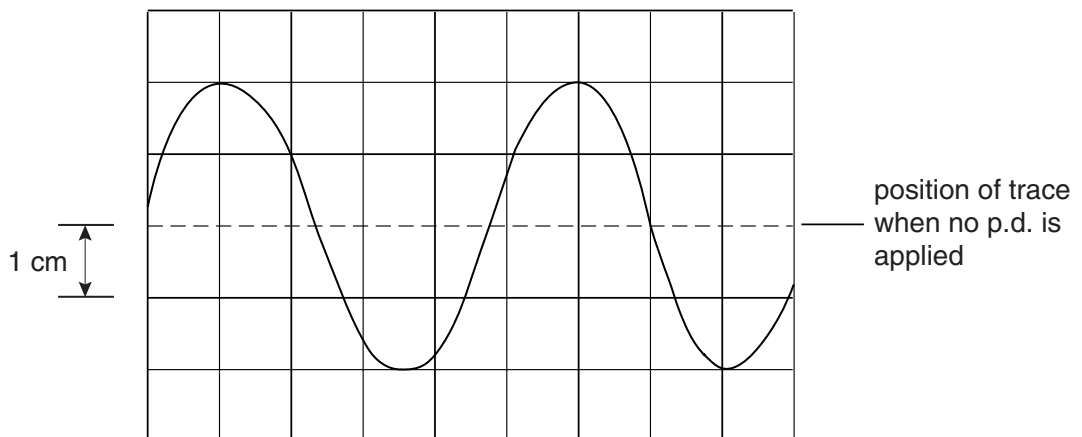

What is the value of the peak voltage?

- A 4 V
- B 5 V
- C 10 V
- D 20 V

- 37 The diagram shows a circuit with a potential divider joined in series with a fixed resistor.

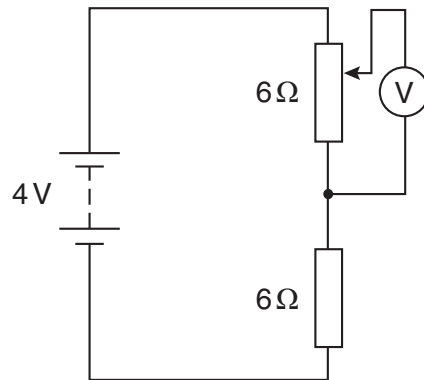

What are the minimum and maximum readings that can be obtained on the voltmeter when the potential divider is adjusted?

	minimum reading / V	maximum reading / V
A	0	2
B	0	6
C	2	4
D	6	12

- 38 **X**, **Y** and **Z** are three types of radiation.

X is almost completely absorbed by 5 cm lead but not by 5 mm aluminium.

Y is almost completely absorbed by 5 mm aluminium but not by thin card.

Z is absorbed by thin card.

What are **X**, **Y** and **Z**?

	X	Y	Z
A	alpha	beta	gamma
B	beta	alpha	gamma
C	gamma	alpha	beta
D	gamma	beta	alpha

39 The nucleus of a nitrogen atom can be represented as ${}^{14}_7\text{N}$.

The nucleus of this atom consists of

- A 7 protons and 7 electrons.
 - B 7 protons and 7 neutrons.
 - C 14 protons and 7 electrons.
 - D 14 protons and 7 neutrons.
- 40 Three nuclei **P**, **Q** and **R** have proton numbers (atomic numbers) and nucleon numbers (mass numbers) as shown.

	proton number	nucleon number
P	43	93
Q	43	94
R	44	94

Which nuclei are isotopes of the same element?

- A **P** and **Q** only
- B **P** and **R** only
- C **Q** and **R** only
- D **P**, **Q** and **R**

BLANK PAGE

BLANK PAGE