



Cambridge O Level

CANDIDATE
NAME

CENTRE
NUMBER

--	--	--	--	--

CANDIDATE
NUMBER

--	--	--	--



PHYSICS

5054/42

Paper 4 Alternative to Practical

May/June 2021

1 hour

You must answer on the question paper.

No additional materials are needed.

INSTRUCTIONS

- Answer **all** questions.
- Use a black or dark blue pen. You may use an HB pencil for any diagrams or graphs.
- Write your name, centre number and candidate number in the boxes at the top of the page.
- Write your answer to each question in the space provided.
- Do **not** use an erasable pen or correction fluid.
- Do **not** write on any bar codes.
- You may use a calculator.
- You should show all your working and use appropriate units.

INFORMATION

- The total mark for this paper is 30.
- The number of marks for each question or part question is shown in brackets [].

This document has **12** pages. Any blank pages are indicated.

BLANK PAGE

- 1 A student investigates how the potential difference (p.d.) V across a fixed resistor R changes as extra resistance is added to the circuit.

(a)

- She sets up the circuit shown in Fig. 1.1.

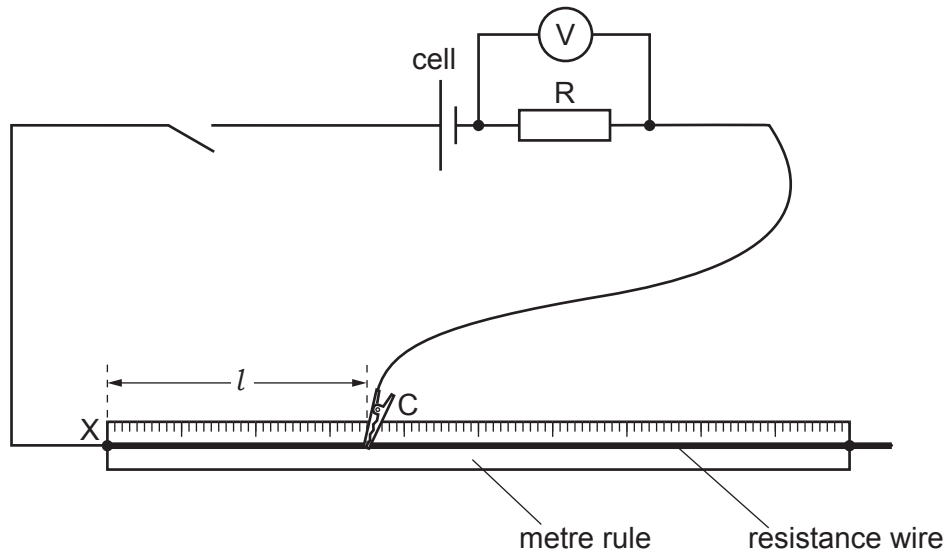

Fig. 1.1

- She connects the crocodile clip C to a point on the resistance wire at a length $l = 20.0$ cm from end X .
- She closes the switch.
- She reads the voltmeter and records the reading.
- She opens the switch.

Fig. 1.2 shows the voltmeter reading.

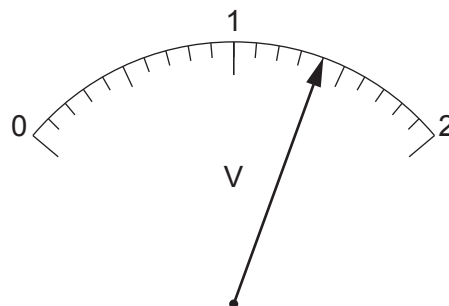

Fig. 1.2

- Read the voltmeter scale and in Table 1.1 on page 4, record the p.d. V . [1]
- Calculate $\frac{1}{V}$ and record its value in Table 1.1 on page 4 to the appropriate number of significant figures. [2]

Table 1.1

length l /cm	potential difference V/V	$\frac{1}{V}/\frac{1}{V}$
20.0		
30.0	1.3	0.77
40.0	1.1	0.91
60.0	0.90	1.1
80.0	0.80	1.3

- (b) She repeats the procedure in (a) using values of $l = 30.0$ cm, 40.0 cm, 60.0 cm and 80.0 cm. Her results are shown in Table 1.1.

Suggest why the student opens the switch between readings.

.....
 [1]

- (c) On the grid provided in Fig. 1.3 on page 5, plot a graph of $\frac{1}{V}$ on the y -axis against l on the x -axis.

Start both axes from the origin (0, 0).

Draw the best-fit straight line. [4]

- (d) (i) Calculate the gradient m of your line. Show all working and indicate on the graph the values you use.

$$m = \dots\dots\dots [2]$$

- (ii) Extend your line until it crosses the y -axis.
 Measure the intercept c that your line makes with the y -axis.

$$c = \dots\dots\dots [1]$$

- (e) Calculate the electromotive force (e.m.f.) E of the cell using the equation:

$$E = \frac{k}{c}$$

where $k = 1.0$ V.

$$E = \dots\dots\dots \text{V} [1]$$



Fig. 1.3

- (f) Suggest **one** practical reason why, despite carrying out the experiment with care, the student's value for E may not be the true value.

.....
..... [1]

- (g) The results in Table 1.1 show that as the length l of resistance wire increases, the potential difference V decreases.

State how the results show that l is **not** inversely proportional to V .

.....
..... [1]

[Total: 14]

2 A student measures the acceleration of a trolley rolling down a ramp.

- He makes a ramp by using a wooden plank, resting one end of the plank on a bench and using a stand and clamp to support the other end.
- He draws a line AB across the ramp near to the top.
- He draws another line CD parallel to AB at a distance $d = 120.0\text{ cm}$ further down the ramp.
- He adjusts the height of the top of the ramp above the bench by moving the clamp until the ramp makes an angle of 30° with the bench.
- He places a trolley on the ramp so that the front wheels of the trolley touch AB.

Fig. 2.1 shows the ramp set up by the student.

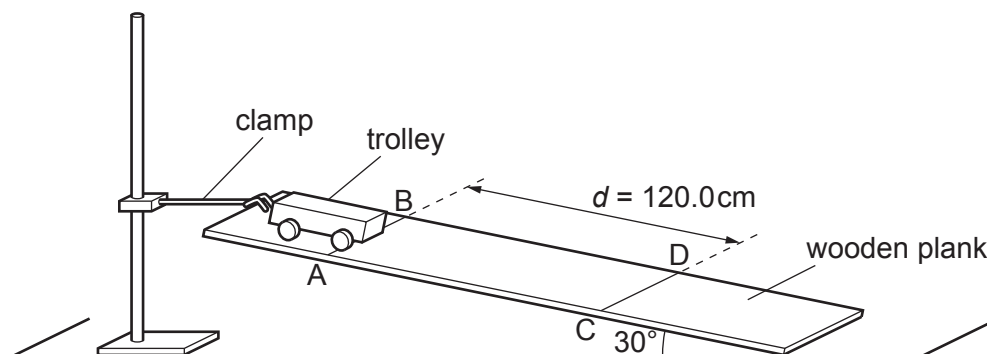

Fig. 2.1

(a) Suggest a measuring device that the student uses to ensure that:

(i) AB and CD are 120.0 cm apart

..... [1]

(ii) the ramp makes an angle of 30° with the bench.

..... [1]

- (b)
- The student releases the trolley and at the same time starts a stopwatch.
 - He stops the stopwatch when the trolley has travelled 120.0 cm down the ramp.
 - He replaces the trolley at the top of the ramp with its front wheels touching AB and repeats the procedure twice.

The times t for the trolley to travel a distance $d = 120.0\text{ cm}$ are shown below.

0.70 s 0.81 s 0.95 s

(i) Suggest **one** reason why there is a large variation in these times.

.....
 [1]

(ii) Fig. 2.2 is a side view of the arrangement with the trolley at the start position.

On Fig. 2.2, draw the position of the trolley when it has travelled 120.0 cm.

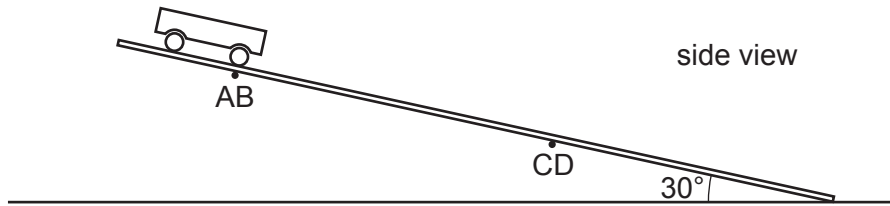

Fig. 2.2

[1]

(iii) Calculate the average time t_{AV} for the trolley to travel a distance $d = 120.0$ cm.

$t_{AV} = \dots\dots\dots$ s [1]

(c) Calculate the acceleration a of the trolley down the ramp using the equation:

$$a = \frac{2d}{t_{AV}^2}$$

Give the unit of your answer.

$a = \dots\dots\dots$ unit $\dots\dots\dots$ [2]

(d) Suggest how the student could modify his experiment so that a more accurate value for the acceleration a of the trolley is obtained.

.....

 [1]

[Total: 8]

- 3 A student measures the focal length f of a convex lens. She sets up the apparatus as shown in Fig. 3.1.

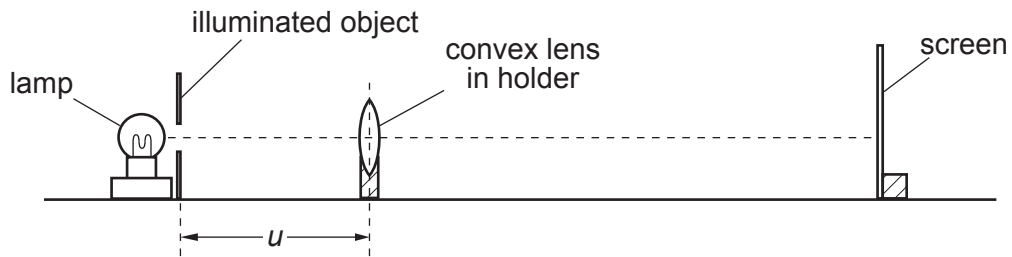

Fig. 3.1

The illuminated object is in the shape of an equilateral triangle, as shown in Fig. 3.2. The object is drawn full size.



Fig. 3.2

- She switches on the lamp and places the lens a distance $u = 20.0$ cm from the illuminated object.
- She adjusts the position of the screen by moving it slowly backwards and forwards until a sharp image of the illuminated object is formed on the screen.

The image of the illuminated object formed on the screen is shown full size in Fig. 3.3.

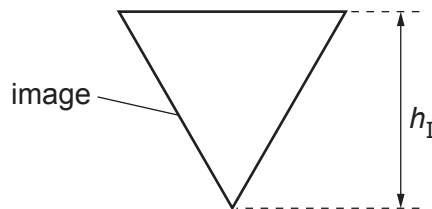

Fig. 3.3

(a) (i) State two differences between the object and the image.

.....

[1]

(ii) Measure the height h_O of the object.

$h_O =$ cm

Measure the height h_I of the image.

$h_I =$ cm
 [1]

(b) Calculate the magnification m of the image using the equation:

$$m = \frac{h_I}{h_O}$$

$m =$ [1]

(c) Calculate the focal length f of the lens using the equation:

$$f = \frac{mu}{(1 + m)} \quad \text{where } u = 20.0 \text{ cm}$$

$f =$ cm [1]

[Total: 4]

- 4 A student uses a plotting compass to plot the pattern of the magnetic field around a straight wire that is carrying a current.

The student sets up a circuit, as shown in Fig. 4.1.

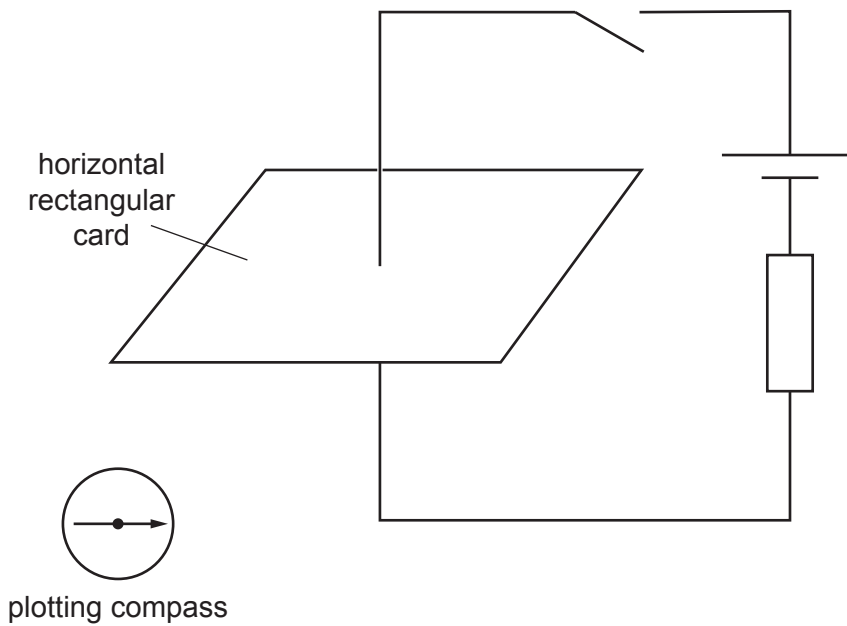

Fig. 4.1

The wire is arranged vertically and it passes through the middle of a horizontal rectangular card.

- (a) Describe how the student uses the plotting compass to plot the pattern of the magnetic field when the switch in the circuit is closed. You may add to Fig. 4.1 to help you explain your answer, if you wish.

.....

.....

.....

.....

.....

.....

.....

..... [3]

- (b) State what else the student can deduce about the magnetic field in this investigation.

.....

..... [1]

[Total: 4]

BLANK PAGE

BLANK PAGE

Permission to reproduce items where third-party owned material protected by copyright is included has been sought and cleared where possible. Every reasonable effort has been made by the publisher (UCLES) to trace copyright holders, but if any items requiring clearance have unwittingly been included, the publisher will be pleased to make amends at the earliest possible opportunity.

To avoid the issue of disclosure of answer-related information to candidates, all copyright acknowledgements are reproduced online in the Cambridge Assessment International Education Copyright Acknowledgements Booklet. This is produced for each series of examinations and is freely available to download at www.cambridgeinternational.org after the live examination series.

Cambridge Assessment International Education is part of the Cambridge Assessment Group. Cambridge Assessment is the brand name of the University of Cambridge Local Examinations Syndicate (UCLES), which itself is a department of the University of Cambridge.