



Cambridge International Examinations
Cambridge Ordinary Level

PHYSICS

5054/11

Paper 1 Multiple Choice

May/June 2016

1 hour

Additional Materials: Multiple Choice Answer Sheet
 Soft clean eraser
 Soft pencil (type B or HB is recommended)

* 5 1 6 0 5 2 2 4 4 *

READ THESE INSTRUCTIONS FIRST

Write in soft pencil.

Do not use staples, paper clips, glue or correction fluid.

Write your name, Centre number and candidate number on the Answer Sheet in the spaces provided unless this has been done for you.

DO NOT WRITE IN ANY BARCODES.

There are **forty** questions on this paper. Answer **all** questions. For each question there are four possible answers **A, B, C** and **D**.

Choose the **one** you consider correct and record your choice in **soft pencil** on the separate Answer Sheet.

Read the instructions on the Answer Sheet very carefully.

Each correct answer will score one mark. A mark will not be deducted for a wrong answer.

Any rough working should be done in this booklet.

Electronic calculators may be used.

This document consists of **16** printed pages.

- 1 The diagram shows arrows representing two vector quantities.



Which diagram shows the resultant R of these two vectors?

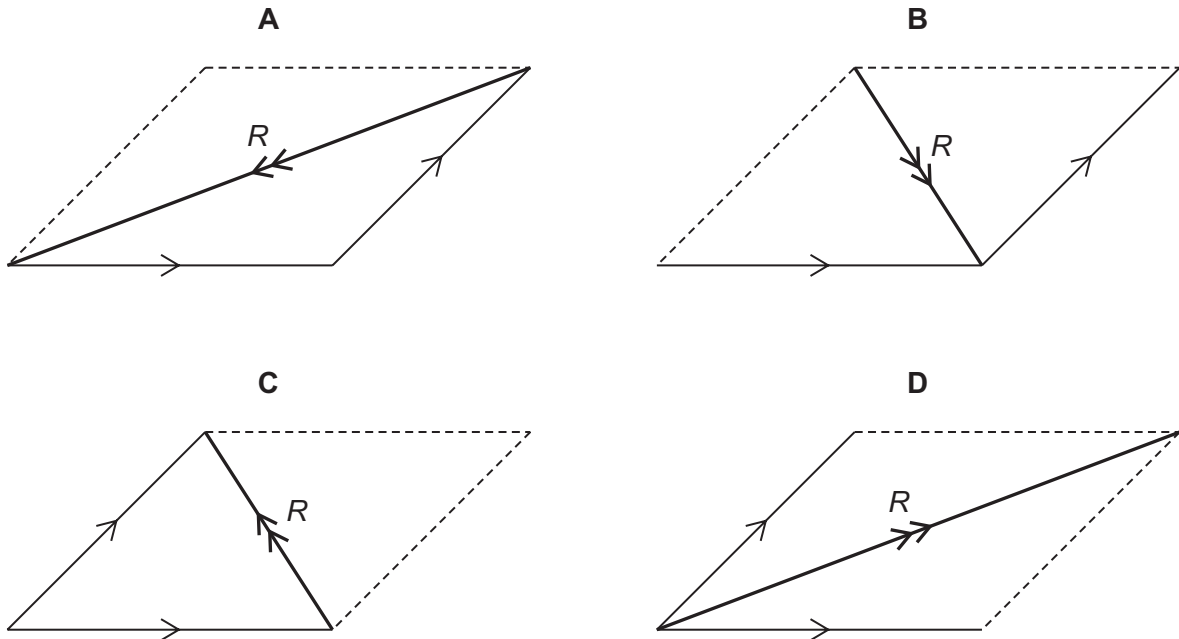

- 2 Which set of quantities are all vectors?
- A acceleration, displacement, velocity
- B chemical energy, mass, power
- C extension, force, gravitational potential energy
- D weight, kinetic energy, work
- 3 A student determines the circumference of a golf ball.

Which instrument gives a reading that is the circumference of the golf ball?

- A calipers
- B micrometer
- C rule
- D tape

- 4 The graph shows how the speed of a car varies with time.

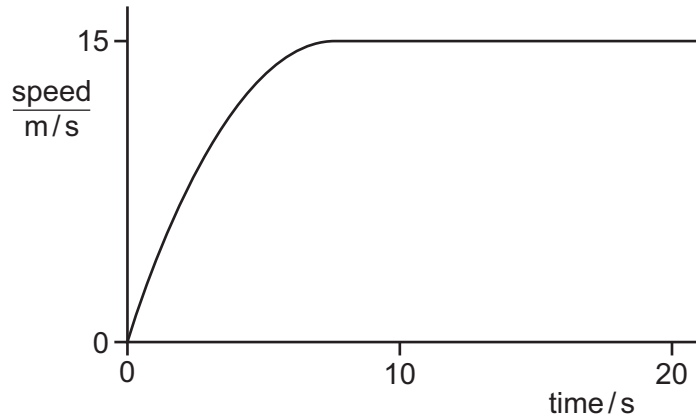

Which statement about the acceleration of the car between 10s and 20s is correct?

- A The acceleration decreases.
 B The acceleration increases.
 C The acceleration is constant, but not zero.
 D The acceleration is zero.
- 5 A man pulls a sledge of mass 25kg across level ground with a horizontal force of 60N. A constant force of friction of 20N acts on the sledge.

What is the acceleration of the sledge?

- A 0.63 m/s^2 B 1.6 m/s^2 C 2.4 m/s^2 D 3.2 m/s^2
- 6 A car moves in a circle at constant speed.

What is the direction of the resultant force acting on the car?

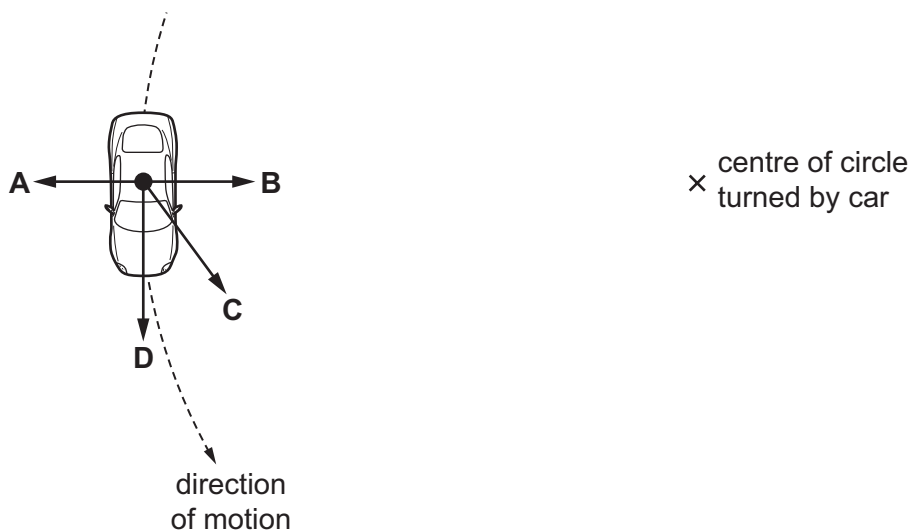

- 7 A brick is placed on a newton meter and then on a beam balance.

newton meter

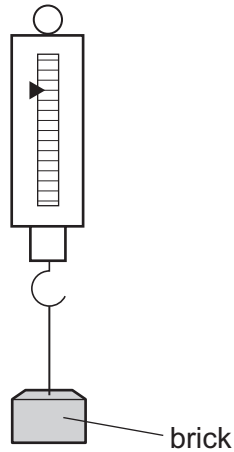

beam balance

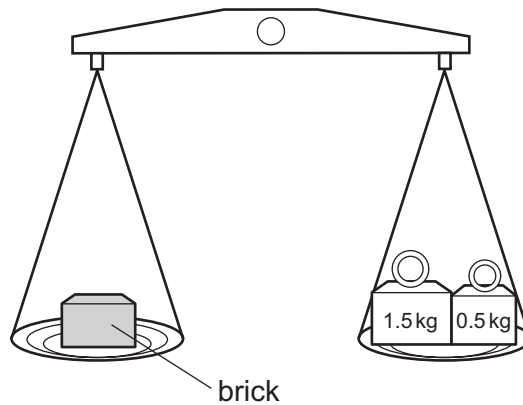

What is measured by each instrument?

	newton meter	beam balance
A	mass	mass
B	mass	weight
C	weight	mass
D	weight	weight

- 8 A force acts on a body.

Which list contains only quantities that can be changed by the force?

- A** mass, shape, velocity
- B** mass, shape, volume
- C** mass, velocity, volume
- D** shape, velocity, volume

- 9 A uniform horizontal beam, pivoted at its right-hand end, is in equilibrium. A force of 60 N acts vertically upwards on the beam as shown.

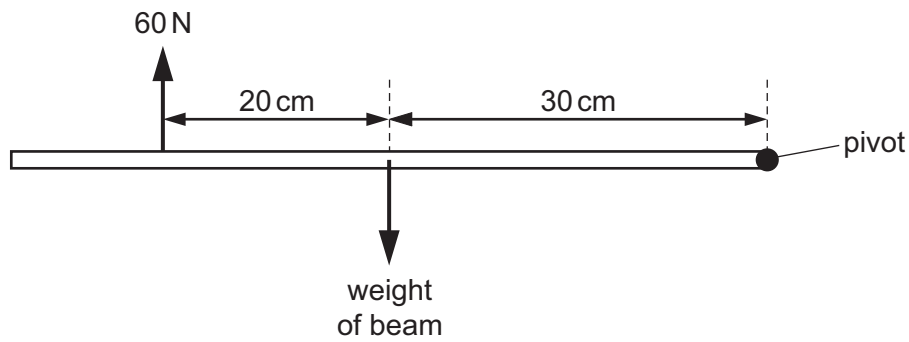

What is the weight of the beam?

- A 36 N B 40 N C 90 N D 100 N
- 10 Four table lamps are shown along with the position M of the centre of mass in each case.

Which lamp is the most stable?

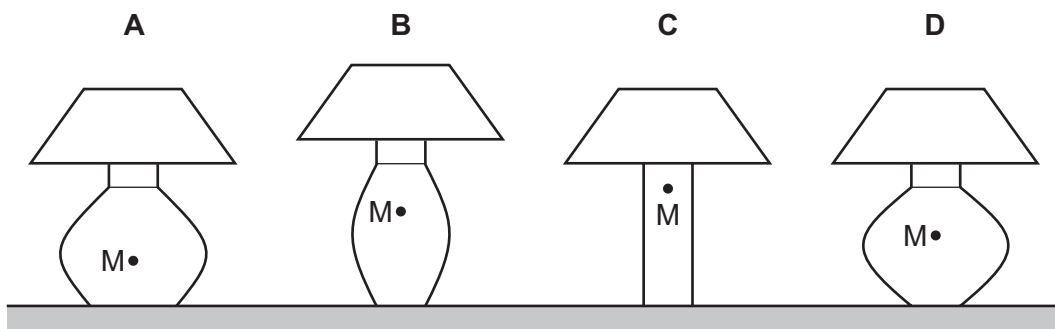

11 A child slides down a slide.

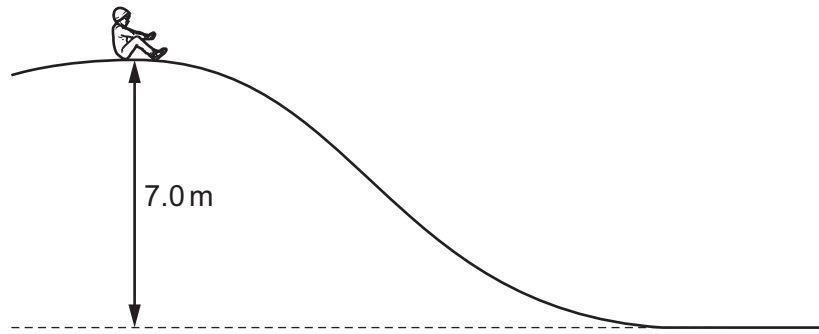

The weight of the child is 250 N. The height of the slide is 7.0 m. The work done against friction as the child travels down the slide is 1300 J.

What is the change in gravitational potential energy and what is the final kinetic energy of the child?

	change in gravitational potential energy	final kinetic energy
A	1750	450
B	1750	1750
C	17 500	16 200
D	17 500	17 500

12 What uses non-renewable energy?

- A** a geothermal heating system
- B** a nuclear power station
- C** a solar panel
- D** a wind turbine

13 Which process in the Sun produces energy?

- A** burning
- B** nuclear fission
- C** nuclear fusion
- D** radiation

- 14 A 300 N force is applied to a box to move it up a ramp, as shown.

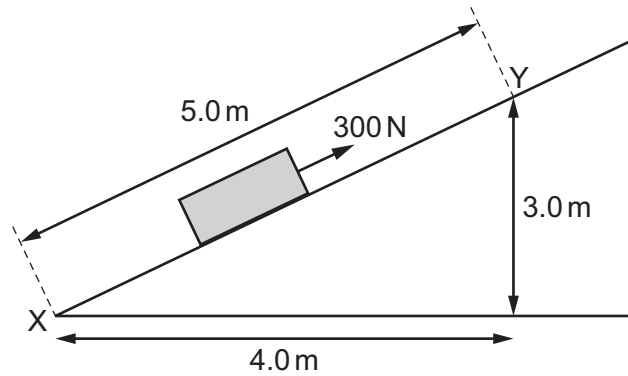

How much work is done by the force when moving the box from X to Y?

- A 900 J B 1200 J C 1500 J D 3000 J
- 15 Four beakers contain the same liquid.

At which point is the pressure the greatest?

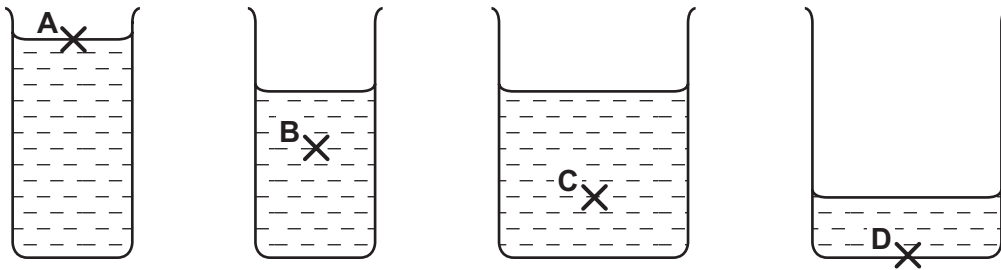

- 16 Water of depth 10 m exerts a pressure equal to atmospheric pressure.

An air bubble rises to the surface of a lake which is 20 m deep. When the bubble reaches the surface, its volume is 6.0 cm^3 .

What is the volume of the air bubble at the bottom of the lake?

- A 2.0 cm^3 B 3.0 cm^3 C 12 cm^3 D 18 cm^3
- 17 A gas in a container of fixed volume is heated.

What happens to the molecules of the gas?

- A They collide less frequently.
 B They expand.
 C They move faster.
 D They move further apart.

18 Which statement about thermal radiation is correct?

- A In a vacuum, thermal radiation travels at the speed of light.
- B Thermal radiation is a longitudinal wave.
- C Thermal radiation travels as an ultra-violet wave.
- D White surfaces are better emitters of thermal radiation than black surfaces.

19 For a transverse wave, what is a *wavefront*?

- A a line joining all points on the same crest of a wave
- B a line showing the displacement of a wave
- C the energy content of a wave
- D the first part of a wave to reach a point

20 A longitudinal wave passes along a spring. The coils of the spring vibrate from side to side.

The diagram shows the positions of the coils at one particular time.



Which positions are one wavelength apart?

- A W and X
- B W and Z
- C X and Z
- D Y and Z

21 Light is incident on a mirror. The light is reflected from the mirror.

The angle of incidence is i and the angle of reflection is r .

Which diagram correctly shows i and r ?

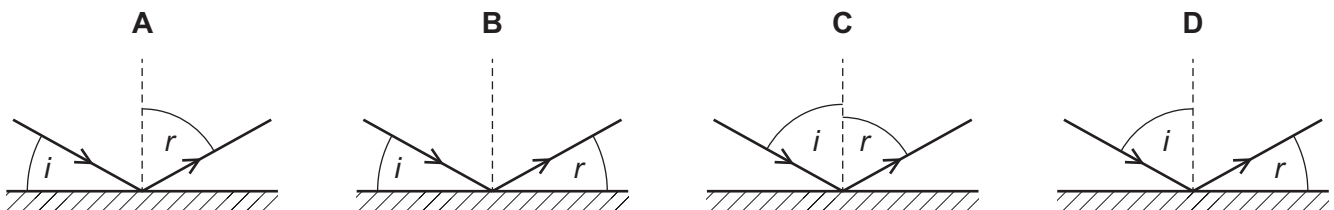

22 Which length is the focal length of the lens shown in the diagram?

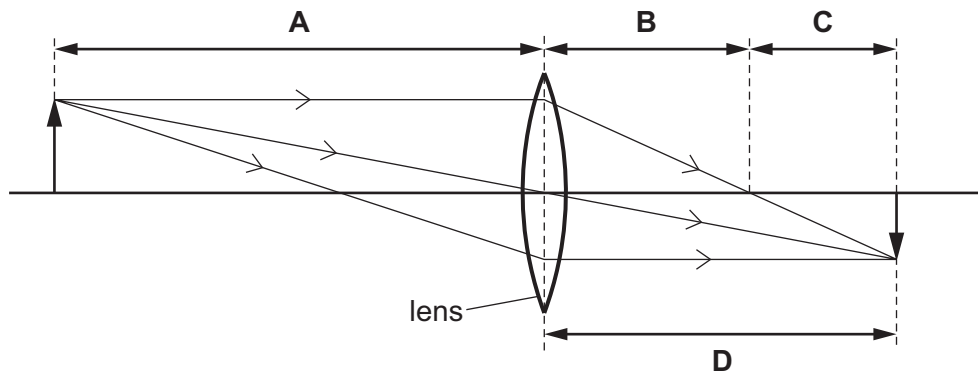

23 Light passes from air into a glass block of refractive index 1.5, as shown.

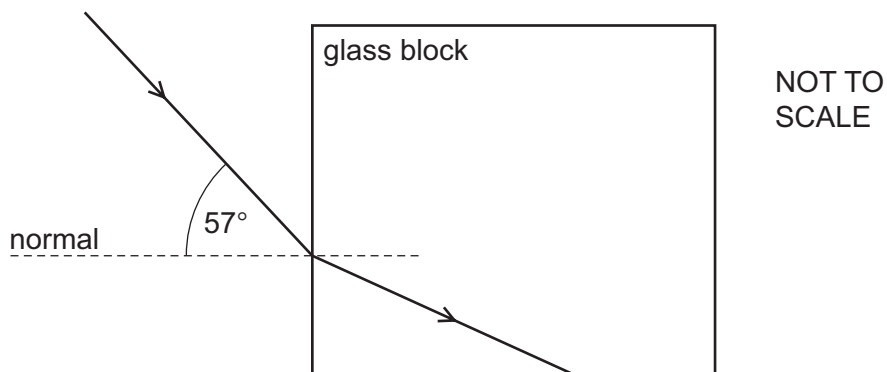

What is the angle of refraction in the glass and what is the critical angle?

	angle of refraction	critical angle
A	34°	42°
B	34°	60°
C	38°	42°
D	38°	60°

24 Microwaves are used to transmit television signals to and from a satellite.

Which statement about microwaves is correct?

- A** They have a longer wavelength than radio waves.
- B** They penetrate the atmosphere without significant loss of energy.
- C** They travel much faster than radio waves in a vacuum.
- D** They warm the satellite and stop it freezing.

25 Where are gamma-rays used?

- A in fluorescent tubes
- B in killing cancerous cells
- C in pre-natal scanning
- D in sunbeds

26 An intruder alarm is adjusted to give a quieter sound without affecting the pitch of the note.

How are the amplitude and the frequency of the sound affected?

	amplitude	frequency
A	lower	lower
B	lower	same
C	same	lower
D	same	same

27 Four plotting compasses are placed near a bar magnet. You may ignore any effects of the Earth's magnetic field.

One compass appears like this  .

What is a possible position for this compass?

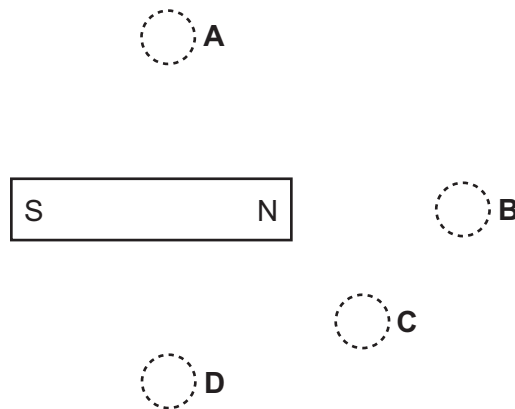

- 28 The diagram shows an uncharged ball coated with metallic paint. The ball is suspended from an insulating thread. It is placed near a positively charged rod.

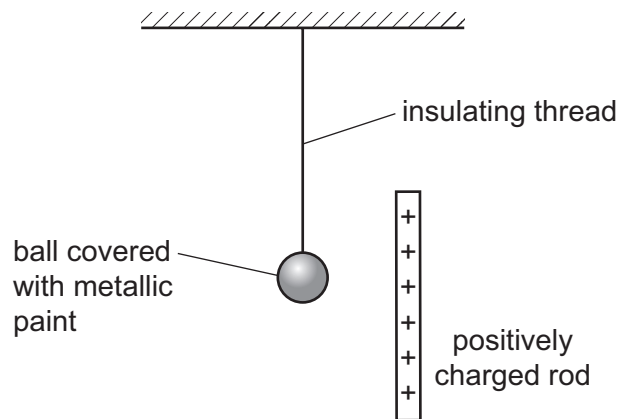

Which diagram shows the charge distribution on the ball?

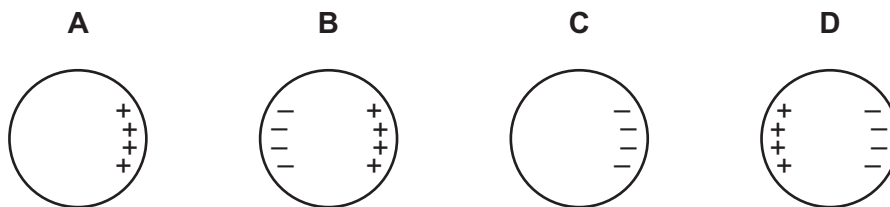

- 29 The current in a car headlamp is 2.0 A. The headlamp is switched on for 4.0 minutes.

How much charge passes through the headlamp?

- A 8.0 C B 30 C C 120 C D 480 C

- 30 How can *one volt* also be expressed?

- A one coulomb per ampere
 B one coulomb per joule
 C one joule per ampere
 D one joule per coulomb

31 The cells, lamps and resistors in the circuits are identical.

In which circuit is the lamp the brightest?

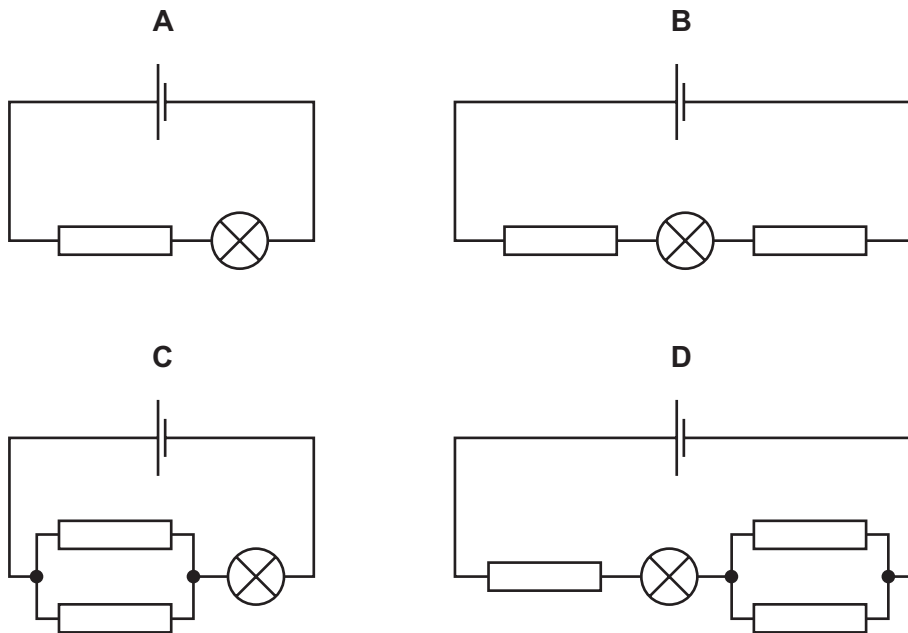

32 The graph is the voltage-current graph for two resistance wires P and Q.

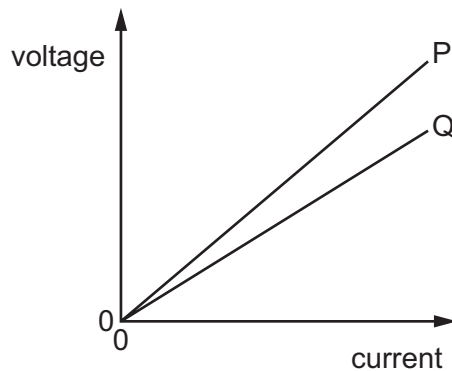

The wires are made from the same material and have equal lengths.

The resistances of the wires and their cross-sectional areas are different.

Which wire has the greater resistance and which wire has the larger cross-sectional area?

	greater resistance	larger cross-sectional area
A	P	P
B	P	Q
C	Q	P
D	Q	Q

33 A lamp is connected to the a.c. mains supply in series with a switch and a fuse.

Which circuit shows these components wired correctly?

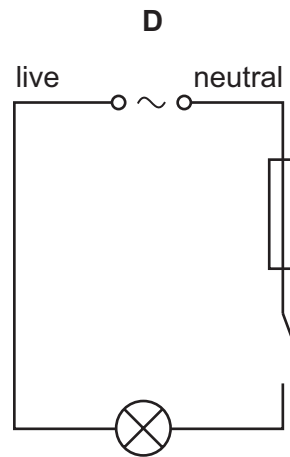
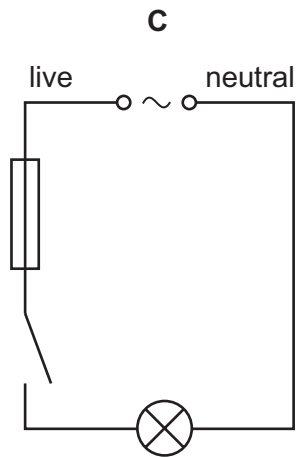
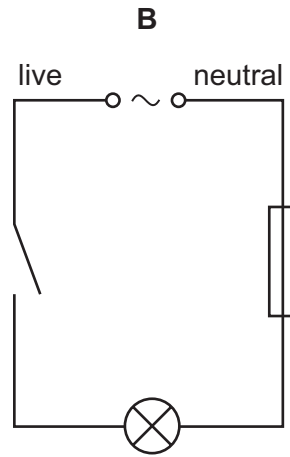
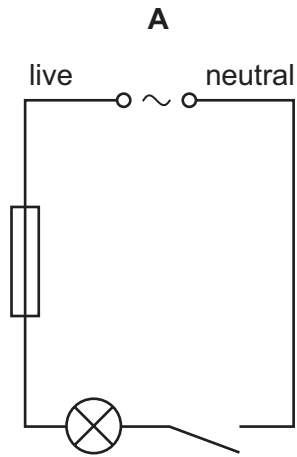

34 A student is investigating resistance using the circuit shown.

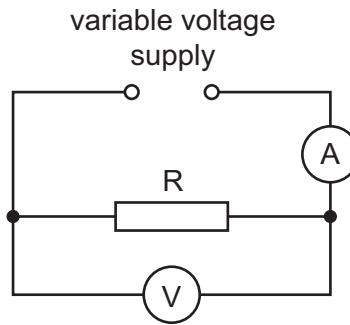

The resistance of R is approximately 5Ω .

What are the most suitable ranges for the voltmeter and for the ammeter?

	voltmeter range	ammeter range
A	0–2V	0–0.5A
B	0–2V	0–2A
C	0–5V	0–5A
D	0–10V	0–5A

35 A split-ring commutator is used in a simple d.c. motor. It reverses the current in the coil.

How often does it reverse the current?

- A** every quarter turn
- B** every half turn
- C** every full turn
- D** every two turns

36 Which component, when used in a circuit, allows current to pass in only one direction?



- 37 A potential divider consists of a thermistor and a light-dependent resistor (LDR).

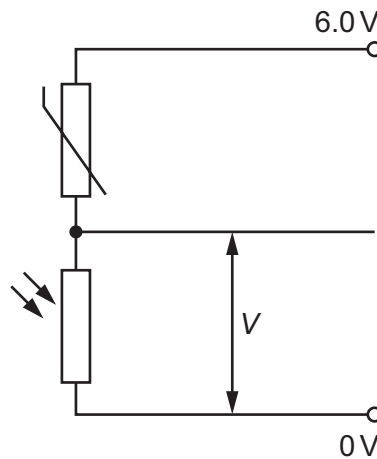

Which conditions give the smallest voltage V across the LDR?

- A cold and dark
 - B cold and light
 - C hot and dark
 - D hot and light
- 38 Which type of radiation consists of electrons?
- A alpha-particles
 - B beta-particles
 - C gamma-rays
 - D X-rays
- 39 A sample of a radioactive isotope produces a count rate of 10 000 counts per minute. The half-life of the isotope is one day.
- What was the count rate of the sample two days ago?
- A 2500 counts per minute
 - B 5000 counts per minute
 - C 20 000 counts per minute
 - D 40 000 counts per minute

- 40 Which statement about a nucleus of $^{15}_7\text{N}$ is correct?
- A The nucleus contains 7 neutrons and 8 protons.
 - B The nucleus contains 7 neutrons and 15 protons.
 - C The nucleus contains 7 protons and 8 neutrons.
 - D The nucleus contains 7 protons and 15 neutrons.

Permission to reproduce items where third-party owned material protected by copyright is included has been sought and cleared where possible. Every reasonable effort has been made by the publisher (UCLES) to trace copyright holders, but if any items requiring clearance have unwittingly been included, the publisher will be pleased to make amends at the earliest possible opportunity.

To avoid the issue of disclosure of answer-related information to candidates, all copyright acknowledgements are reproduced online in the Cambridge International Examinations Copyright Acknowledgements Booklet. This is produced for each series of examinations and is freely available to download at www.cie.org.uk after the live examination series.

Cambridge International Examinations is part of the Cambridge Assessment Group. Cambridge Assessment is the brand name of University of Cambridge Local Examinations Syndicate (UCLES), which is itself a department of the University of Cambridge.