

| | | |
|---------------|------------------|------|
| Centre Number | Candidate Number | Name |
|---------------|------------------|------|

UNIVERSITY OF CAMBRIDGE INTERNATIONAL EXAMINATIONS
General Certificate of Education Ordinary Level

PHYSICS**5054/04**

Paper 4 Alternative to Practical

May/June 2004

1 hour

Candidates answer on the Question Paper.
No Additional Materials are required.

READ THESE INSTRUCTIONS FIRST

Write your Centre number, candidate number and name on all the work you hand in.
Write in dark blue or black pen in the spaces provided on the Question Paper.
You may use a soft pencil for any diagrams, graphs or rough working.
Do not use staples, paper clips, highlighters, glue or correction fluid.

Answer **all** questions.

At the end of the examination, fasten all your work securely together.

The number of marks is given in brackets [] at the end of each question or part question.

| For Examiner's Use | |
|--------------------|--|
| 1 | |
| 2 | |
| 3 | |
| 4 | |
| 5 | |
| Total | |

If you have been given a label, look at the details. If any details are incorrect or missing, please fill in your correct details in the space given at the top of this page.

Stick your personal label here, if provided.

This document consists of **9** printed pages and **3** blank pages.



- 1 Light from an extended source **XY** is allowed to pass through a circular hole in a piece of card and to illuminate part of a screen. The apparatus is shown in Fig. 1.1.

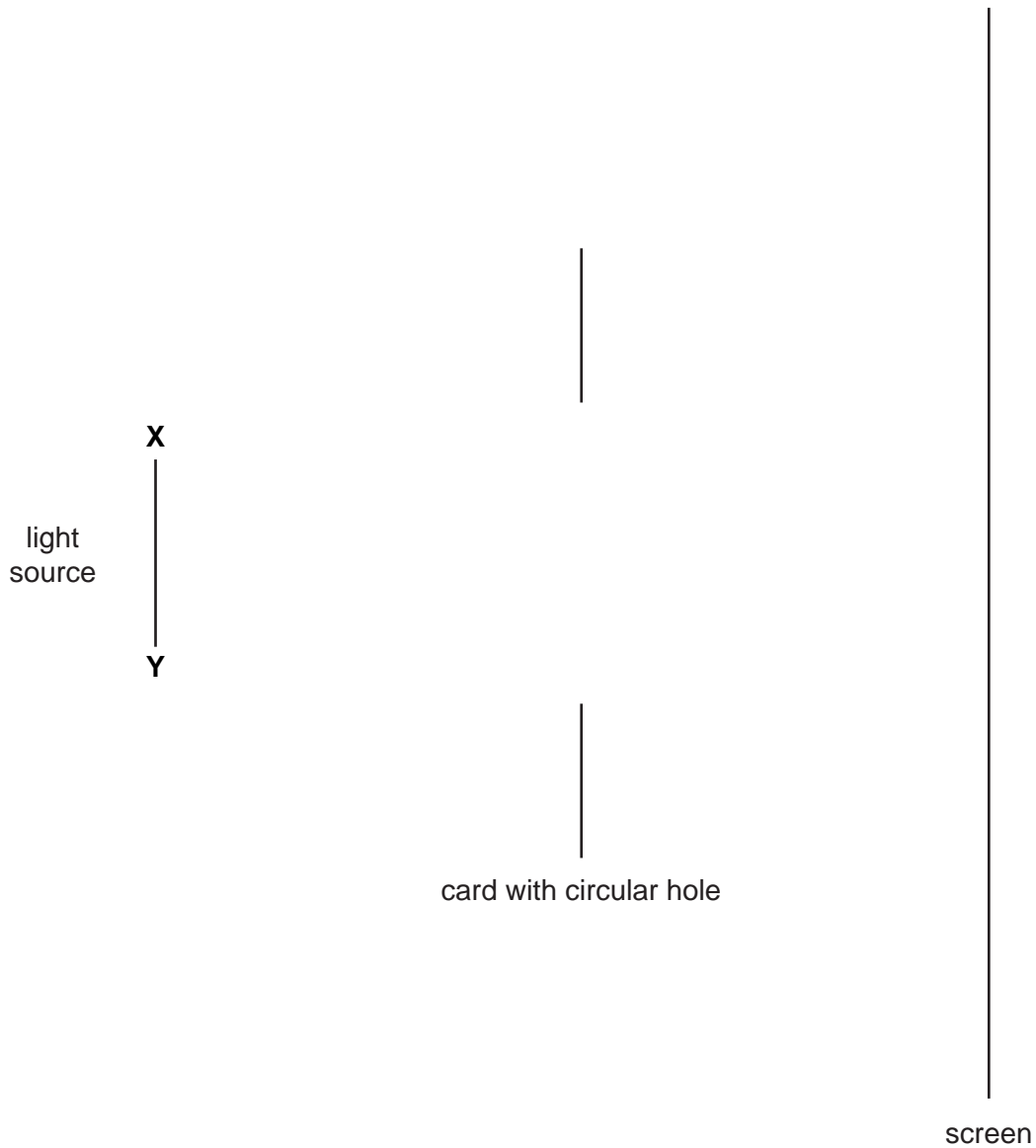

Fig. 1.1

- (a) (i) Carefully draw the paths of the rays to show the part of the screen illuminated by point **X**. Use the labels **X₁** and **X₂** to show this part of the screen.
- (ii) Carefully draw the paths of the rays to show the part of the screen illuminated by point **Y**. Use the labels **Y₁** and **Y₂** to show this part of the screen.

[4]

- (b) Measure and record the diameter of the area of that part of the screen illuminated by all of the source **XY**.

diameter =[1]

- 2 A diode is an electrical device that lets current pass through it in one direction only. The circuit symbol for a diode is shown in Fig. 2.1.

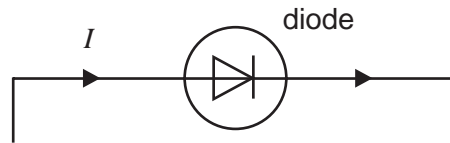

Fig. 2.1

The arrow shows the direction of the conventional current I when the diode is conducting.

- (a) Complete Fig. 2.1 to show a series circuit that includes
- (i) a 1.5 V power supply of fixed voltage, connected so that the diode is conducting,
 - (ii) an ammeter to measure the diode current I ,
 - (iii) a switch,
 - (iv) a lamp, rated at 1.25 V, 0.25 A, in series with the diode and the power supply.

[3]

- (b) On Fig. 2.1, mark with a '+' sign the positive terminals of the power supply and the ammeter.

[1]

- (c) What would happen if the diode is connected the other way round?

.....
[1]

- (d) Why is it necessary to include a lamp in this circuit?

.....
[1]

- 3 In Fig. 3.1, the length l of a mercury thread in a mercury thermometer is plotted against the temperature θ recorded on the thermometer.

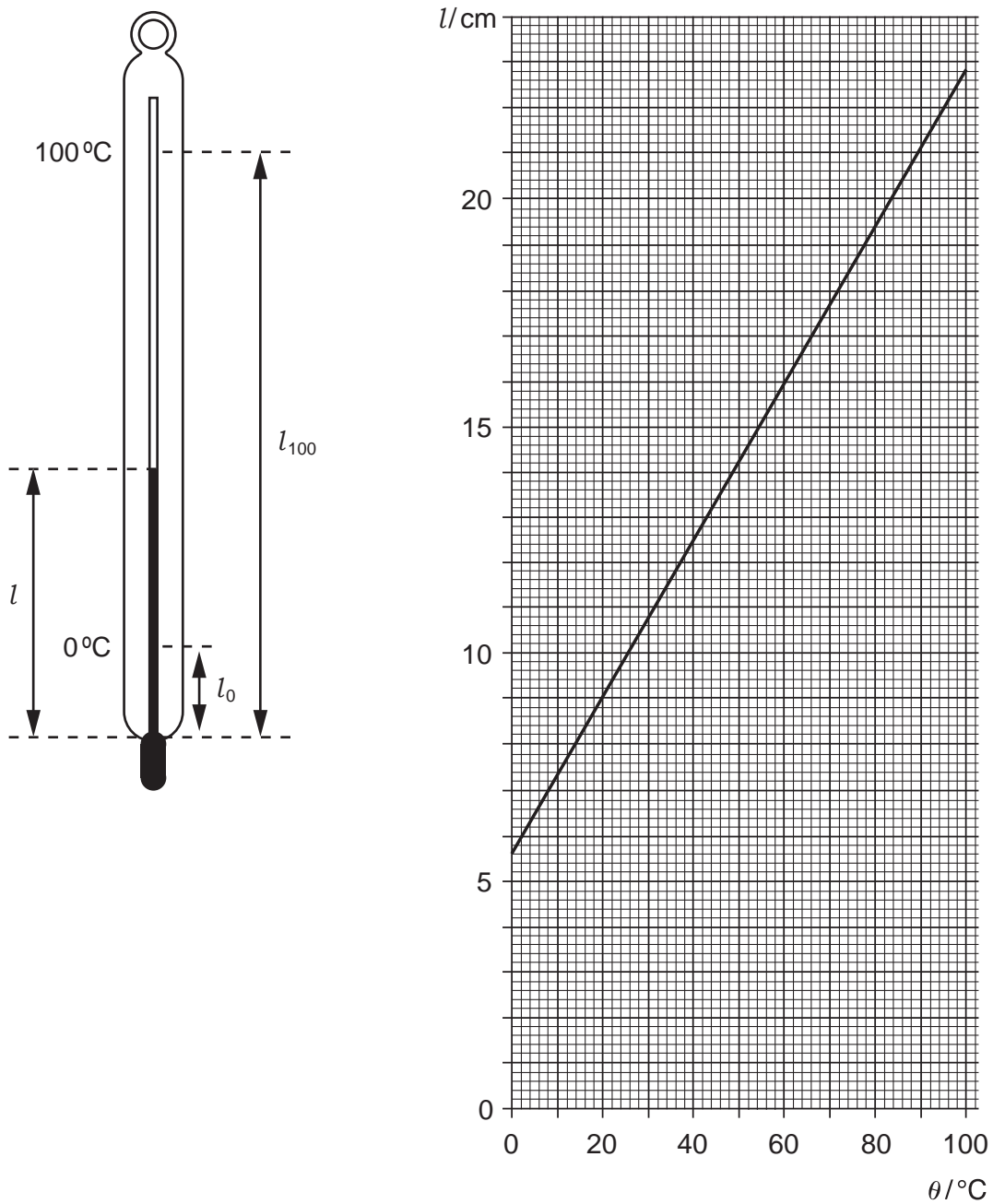

Fig. 3.1

- (a) Describe how you would measure the length l of the mercury thread on a day when the laboratory temperature is 25 °C. You should use a 300 mm rule with a dead space at each end, as shown in Fig. 3.2. In your answer, state what readings you would take and how you would make your readings accurate. You may draw a diagram if you wish.

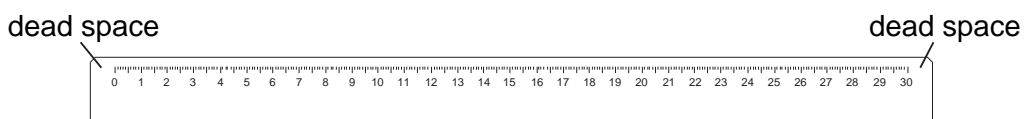

Fig. 3.2

.....
.....
.....
.....
.....[3]

(b) (i) Using the graph in Fig. 3.1, determine l_0 (the value for l when θ is 0°C) and l_{100} (the value for l when θ is 100°C).

$l_0 =$

$l_{100} =$

(ii) Hence calculate the increase in l when the temperature is raised by 1°C .

(iii) Describe how l varies with θ .

.....
.....

[3]

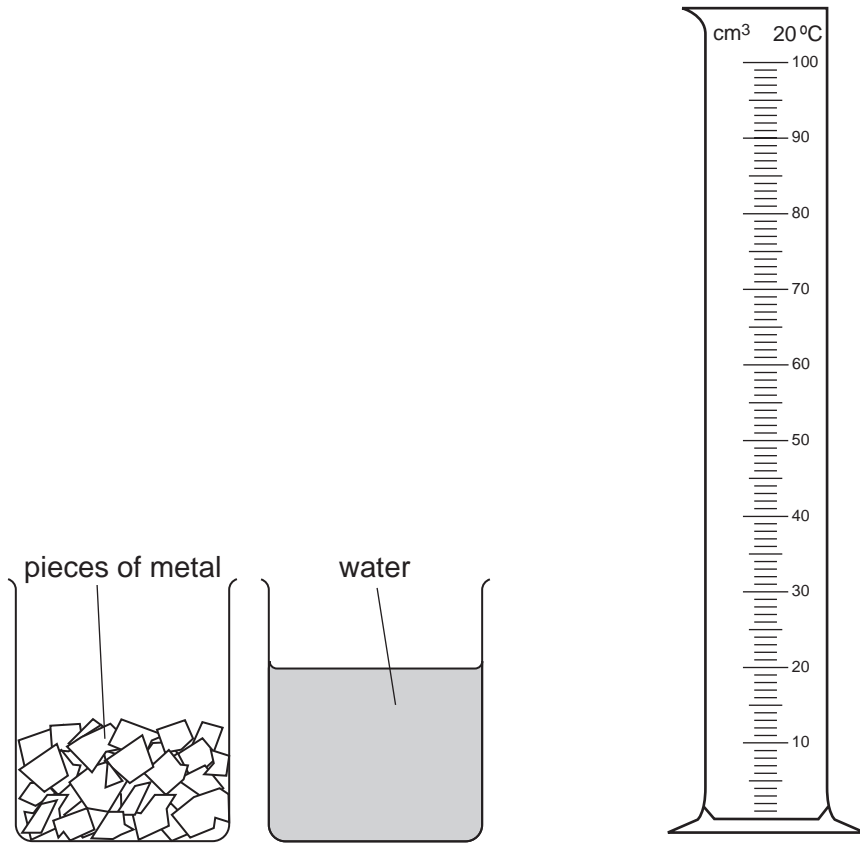

Fig. 4.1

(b) Suggest why the temperature 20 °C is marked on the measuring cylinder.

.....
.....[1]

(c) If you were asked to repeat the experiment, explain why you would dry the wet pieces of metal before you started again.

.....
.....[1]

- 5 A converging lens is to be used to produce a focused image on a screen.
A student sets up the apparatus as shown in Fig. 5.1.

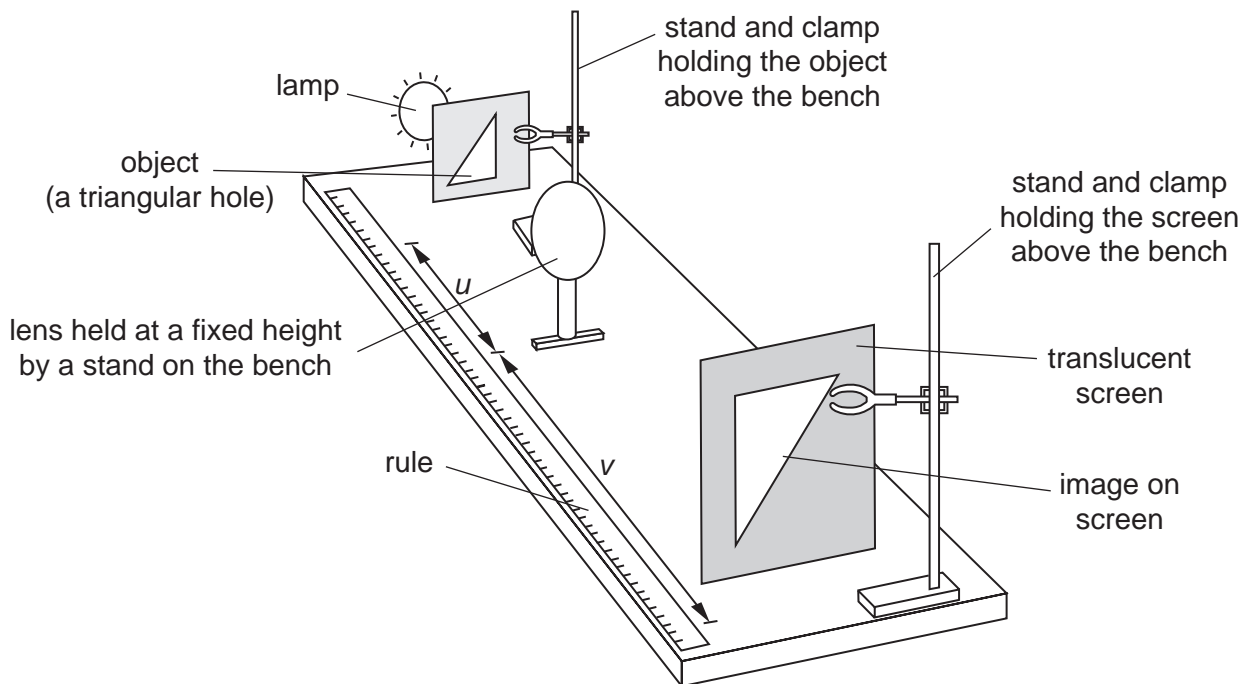

Fig. 5.1

The image is located for different object distances. In each case the distances labelled u and v are measured. The values obtained are given in Fig. 5.2.

| | | | | | | |
|---------------|-----|-----|-----|-----|-----|-----|
| u/mm | 169 | 180 | 200 | 222 | 235 | 280 |
| v/mm | 299 | 280 | 234 | 210 | 200 | 175 |

Fig. 5.2

- (a) Using the grid on page 9, plot the graph of v/mm (y -axis) against u/mm (x -axis). Start the axes from the point where $u/\text{mm} = 150$ and $v/\text{mm} = 150$. Draw the best curve through the graph plots. [4]

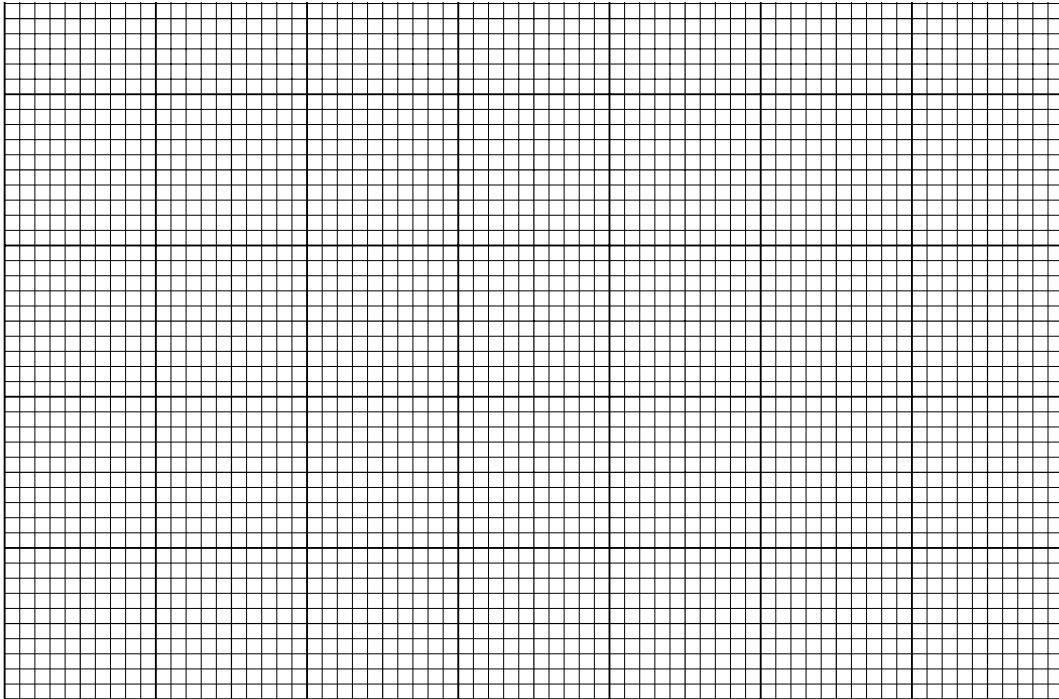

(b) Another student attempts the experiment. This student does **not** obtain a full image of the object on the screen. In this attempt, only a clear focussed image of the top of the object is formed at the top of the screen.

(i) Draw a diagram to illustrate an arrangement of the apparatus that would cause only this part of the image to appear on the screen. On your diagram, draw a line to show the path of a ray from the top of the object to the corresponding point on the image.

(ii) How would you adjust the apparatus so that a full image appears in the centre of the screen?

.....
.....

[3]

BLANK PAGE

BLANK PAGE

BLANK PAGE