

Write your name here

Surname

Other names

Centre Number

Candidate Number

**Pearson Edexcel  
International GCSE**

--	--	--	--	--

--	--	--	--

# Mathematics A

**Paper 3HR**



**Higher Tier**

Thursday 25 May 2017 – Morning

**Time: 2 hours**

Paper Reference

**4MA0/3HR**

**You must have:**

Ruler graduated in centimetres and millimetres, protractor, compasses, pen, HB pencil, eraser, calculator. Tracing paper may be used.

Total Marks

## Instructions

- Use **black** ink or ball-point pen.
- **Fill in the boxes** at the top of this page with your name, centre number and candidate number.
- Answer **all** questions.
- Without sufficient working, correct answers may be awarded no marks.
- Answer the questions in the spaces provided  
– *there may be more space than you need.*
- **Calculators may be used.**
- You must **NOT** write anything on the formulae page.  
Anything you write on the formulae page will gain **NO** credit.

## Information

- The total mark for this paper is 100.
- The marks for **each** question are shown in brackets  
– *use this as a guide as to how much time to spend on each question.*

## Advice

- Read each question carefully before you start to answer it.
- Check your answers if you have time at the end.

Turn over ►

P48488A

©2017 Pearson Education Ltd.

1/1/1



Pearson

**International GCSE MATHEMATICS  
FORMULAE SHEET – HIGHER TIER**

Pythagoras' Theorem

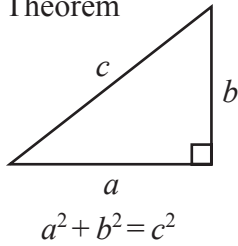

Volume of cone =  $\frac{1}{3} \pi r^2 h$

Curved surface area of cone =  $\pi r l$

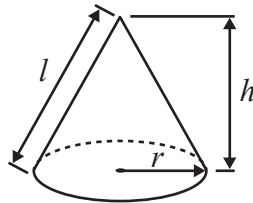

Volume of sphere =  $\frac{4}{3} \pi r^3$

Surface area of sphere =  $4 \pi r^2$

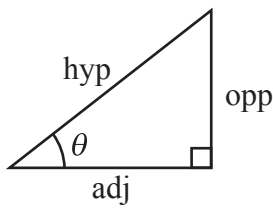
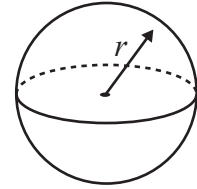

adj = hyp  $\times$  cos  $\theta$   
opp = hyp  $\times$  sin  $\theta$   
opp = adj  $\times$  tan  $\theta$

or  $\sin \theta = \frac{\text{opp}}{\text{hyp}}$

$\cos \theta = \frac{\text{adj}}{\text{hyp}}$

$\tan \theta = \frac{\text{opp}}{\text{adj}}$

In any triangle ABC

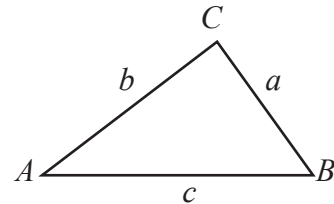

Sine rule:  $\frac{a}{\sin A} = \frac{b}{\sin B} = \frac{c}{\sin C}$

Cosine rule:  $a^2 = b^2 + c^2 - 2bc \cos A$

Area of triangle =  $\frac{1}{2} ab \sin C$

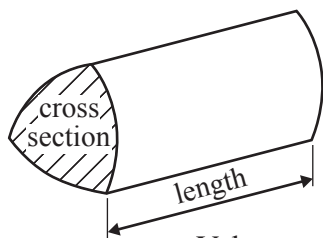

Volume of prism = area of cross section  $\times$  length

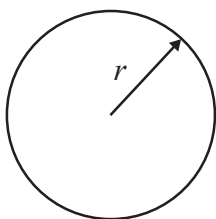

Circumference of circle =  $2 \pi r$

Area of circle =  $\pi r^2$

Area of a trapezium =  $\frac{1}{2}(a + b)h$

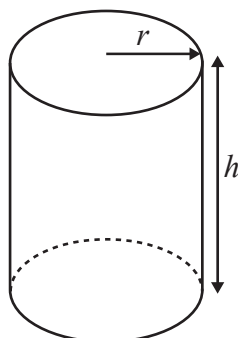
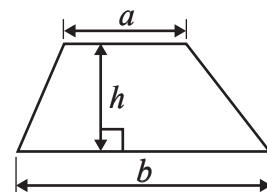

Volume of cylinder =  $\pi r^2 h$

Curved surface area of cylinder =  $2 \pi r h$

The Quadratic Equation

The solutions of  $ax^2 + bx + c = 0$ , where  $a \neq 0$ , are given by

$$x = \frac{-b \pm \sqrt{b^2 - 4ac}}{2a}$$

DO NOT WRITE IN THIS AREA

DO NOT WRITE IN THIS AREA

DO NOT WRITE IN THIS AREA



Answer ALL TWENTY ONE questions.

Write your answers in the spaces provided.

You must write down all the stages in your working.

1  $a = 6$        $b = 2.84$        $c = \sqrt{5}$

Work out the value of  $\frac{a - b}{c^2}$

.....  
(Total for Question 1 is 2 marks)

2 Solve  $5x - 8 = x - 10$   
Show clear algebraic working.

$x =$  .....

(Total for Question 2 is 3 marks)

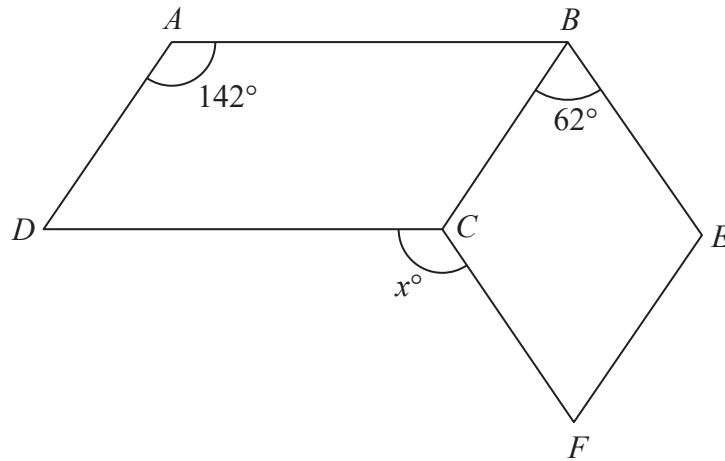

3

Diagram **NOT**  
accurately drawn

$ABCD$  is a parallelogram.  
 $BEFC$  is a rhombus.

Angle  $DAB = 142^\circ$   
 Angle  $CBE = 62^\circ$

Calculate the value of  $x$ .

$x = \dots\dots\dots$

(Total for Question 3 is 3 marks)

DO NOT WRITE IN THIS AREA

DO NOT WRITE IN THIS AREA

DO NOT WRITE IN THIS AREA

4



- 4 The currency in Bangladesh is the taka.  
1 pound (£) = 119 taka

- (a) Change 3500 taka to pounds.  
Give your answer correct to 2 decimal places.

£.....  
(2)

The currency in Thailand is the baht.  
1 pound (£) = 52 baht

- (b) Change 8500 baht to taka.  
Give your answer correct to the nearest whole number.

..... taka  
(3)

An aeroplane takes 2 hours and 24 minutes to fly from Bangkok to Dhaka.  
The aeroplane flies a distance of 1534 km.

- (c) Work out the average speed of the aeroplane.  
Give your answer in kilometres per hour correct to 3 significant figures.

..... kilometres per hour  
(3)

(Total for Question 4 is 8 marks)



5 There is a World Peace Bell in South Korea.

At its widest, the bell has a circular cross section with a diameter of 2.5 m.

- (a) Work out the circumference of a circle with diameter 2.5 m.  
Give your answer correct to 3 significant figures.

..... m  
(2)

The World Peace Bell in South Korea has a height of 4.7 m.

At its widest, the bell has a circular cross section with a diameter of 2.5 m.

A scale model is made of the bell.

At its widest, the scale model has a circular cross section with a diameter 10 cm.

- (b) Work out the height of the scale model.  
Give your answer in centimetres.

..... cm  
(2)

**(Total for Question 5 is 4 marks)**

DO NOT WRITE IN THIS AREA

DO NOT WRITE IN THIS AREA

DO NOT WRITE IN THIS AREA



6 Ahmed, Beth and Cleo are three friends.

The mean age, in years, of Ahmed, Beth and Cleo is 21

The mean age, in years, of Ahmed and Beth is 19

(a) Work out Cleo's age.

..... years  
(3)

Ahmed is the youngest of the three friends.

The median age, in years, of the three friends is 20

(b) Find the range of their ages.

..... years  
(3)

**(Total for Question 6 is 6 marks)**

DO NOT WRITE IN THIS AREA

DO NOT WRITE IN THIS AREA

DO NOT WRITE IN THIS AREA



- 7 Write 336 as a product of its prime factors.  
Show your working clearly.

(Total for Question 7 is 3 marks)

8

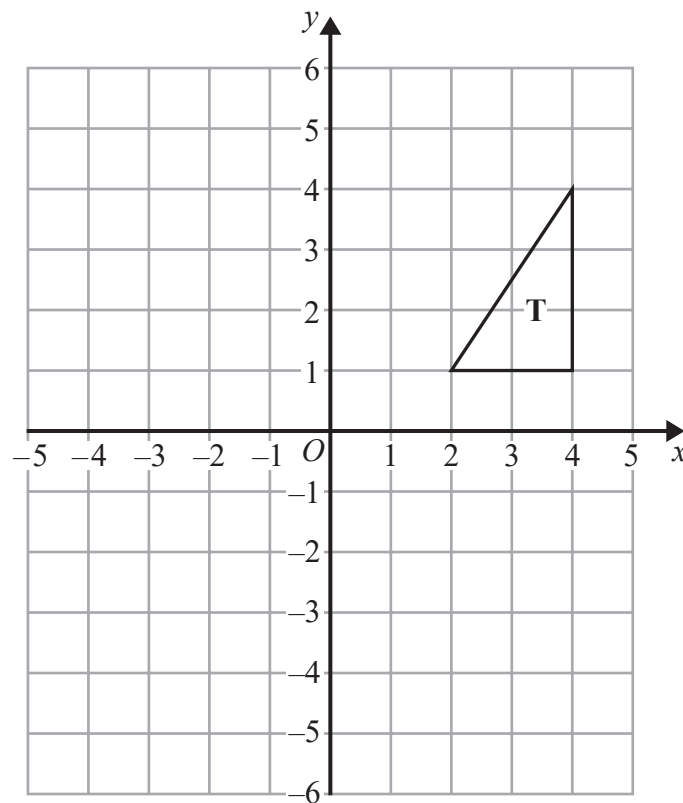

- (a) On the grid above, rotate triangle T  $90^\circ$  clockwise about (0, 2).

(2)

DO NOT WRITE IN THIS AREA

DO NOT WRITE IN THIS AREA

DO NOT WRITE IN THIS AREA





DO NOT WRITE IN THIS AREA

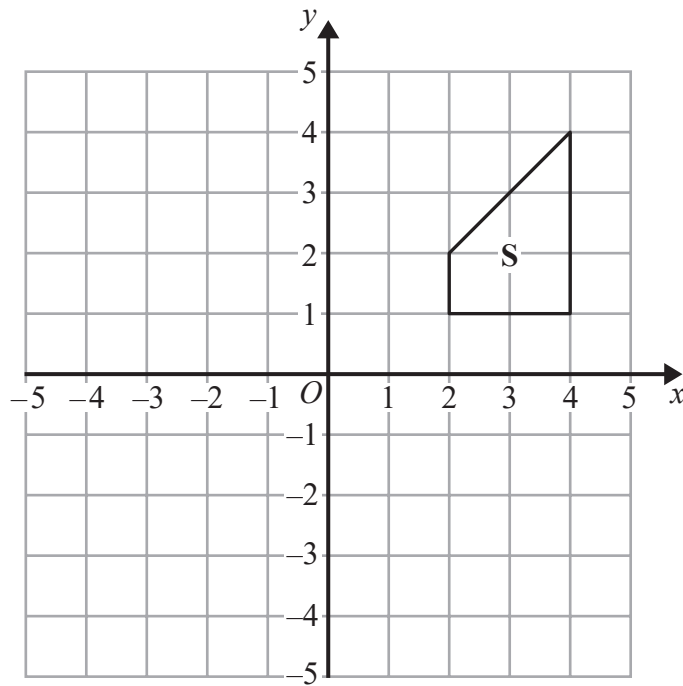

- (b) On the grid, translate shape S by the vector  $\begin{pmatrix} -1 \\ -3 \end{pmatrix}$ . (1)

(Total for Question 8 is 3 marks)

- 9 (a) Simplify  $2e^2f \times 5e^3f$

.....  
(2)

- (b) Factorise  $x^2 - 5x - 6$

.....  
(2)

(Total for Question 9 is 4 marks)

DO NOT WRITE IN THIS AREA



10 The price of 1 kg of silver on 1st January 2010 was \$607  
By 1st January 2015, the price of 1 kg of silver had decreased by 9.4%

- (a) Work out the price of 1 kg of silver on 1st January 2015.  
Give your answer correct to the nearest dollar (\$).

\$.....  
(3)

Between 1st January 2010 and 1st January 2015, the price of 1 tonne of copper decreased  
by 20%

This was a decrease of \$1320

- (b) Work out the price of 1 tonne of copper on 1st January 2010.

\$.....  
(3)

(Total for Question 10 is 6 marks)

DO NOT WRITE IN THIS AREA

DO NOT WRITE IN THIS AREA

DO NOT WRITE IN THIS AREA



DO NOT WRITE IN THIS AREA

DO NOT WRITE IN THIS AREA

DO NOT WRITE IN THIS AREA

- 11 There are 9 red counters and 11 blue counters in a bag.  
There are no other counters in the bag.

Emeka takes at random a counter from the bag and writes down the colour of the counter.  
He puts the counter back in the bag.  
Natasha takes at random a counter from the bag and writes down the colour of the counter.

- (a) Complete the probability tree diagram.

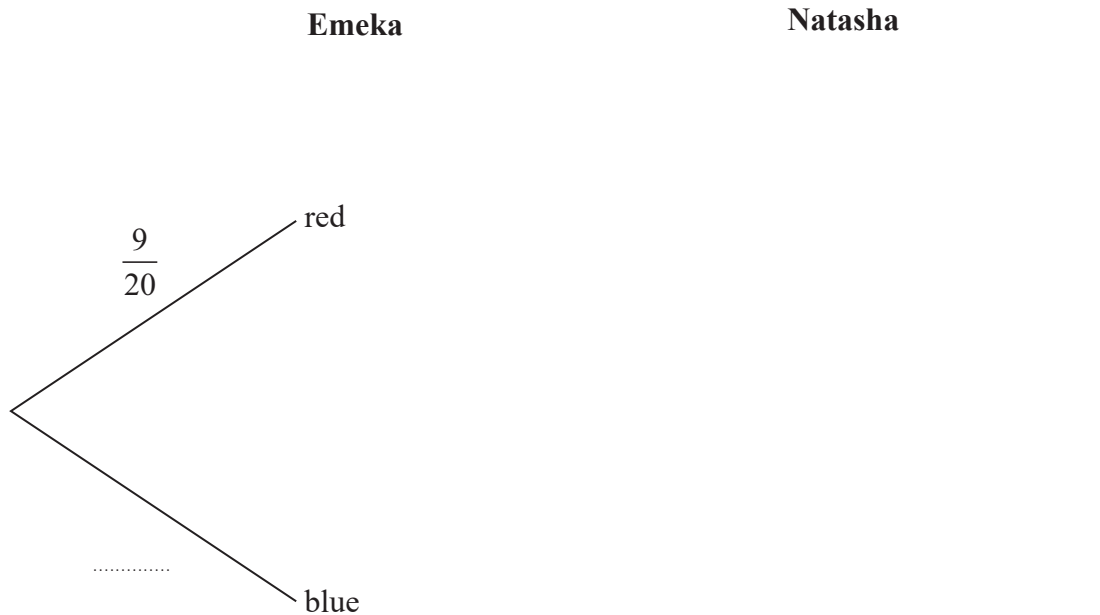

(2)

- (b) Work out the probability that Emeka takes a red counter from the bag and Natasha takes a blue counter from the bag.

.....  
(2)

- (c) Work out the probability that both counters taken from the bag are the same colour.

.....  
(3)

(Total for Question 11 is 7 marks)



- 12 The table gives information about the number of males in each age group in a survey of 100 males working in Singapore in 2014.

Age ( $A$ years)	Frequency
$15 \leq A < 20$	2
$20 \leq A < 25$	7
$25 \leq A < 30$	9
$30 \leq A < 35$	10
$35 \leq A < 40$	11
$40 \leq A < 45$	12
$45 \leq A < 50$	12
$50 \leq A < 55$	12
$55 \leq A < 60$	11
$60 \leq A < 65$	14

- (a) Complete the cumulative frequency table.

Age ( $A$ years)	Cumulative frequency
$15 \leq A < 20$	
$15 \leq A < 25$	
$15 \leq A < 30$	
$15 \leq A < 35$	
$15 \leq A < 40$	
$15 \leq A < 45$	
$15 \leq A < 50$	
$15 \leq A < 55$	
$15 \leq A < 60$	
$15 \leq A < 65$	

(1)

- (b) On the grid, draw a cumulative frequency graph for your table.

(2)

- (c) Use your graph to find an estimate for the lower quartile.

..... years

(2)

DO NOT WRITE IN THIS AREA

DO NOT WRITE IN THIS AREA

DO NOT WRITE IN THIS AREA



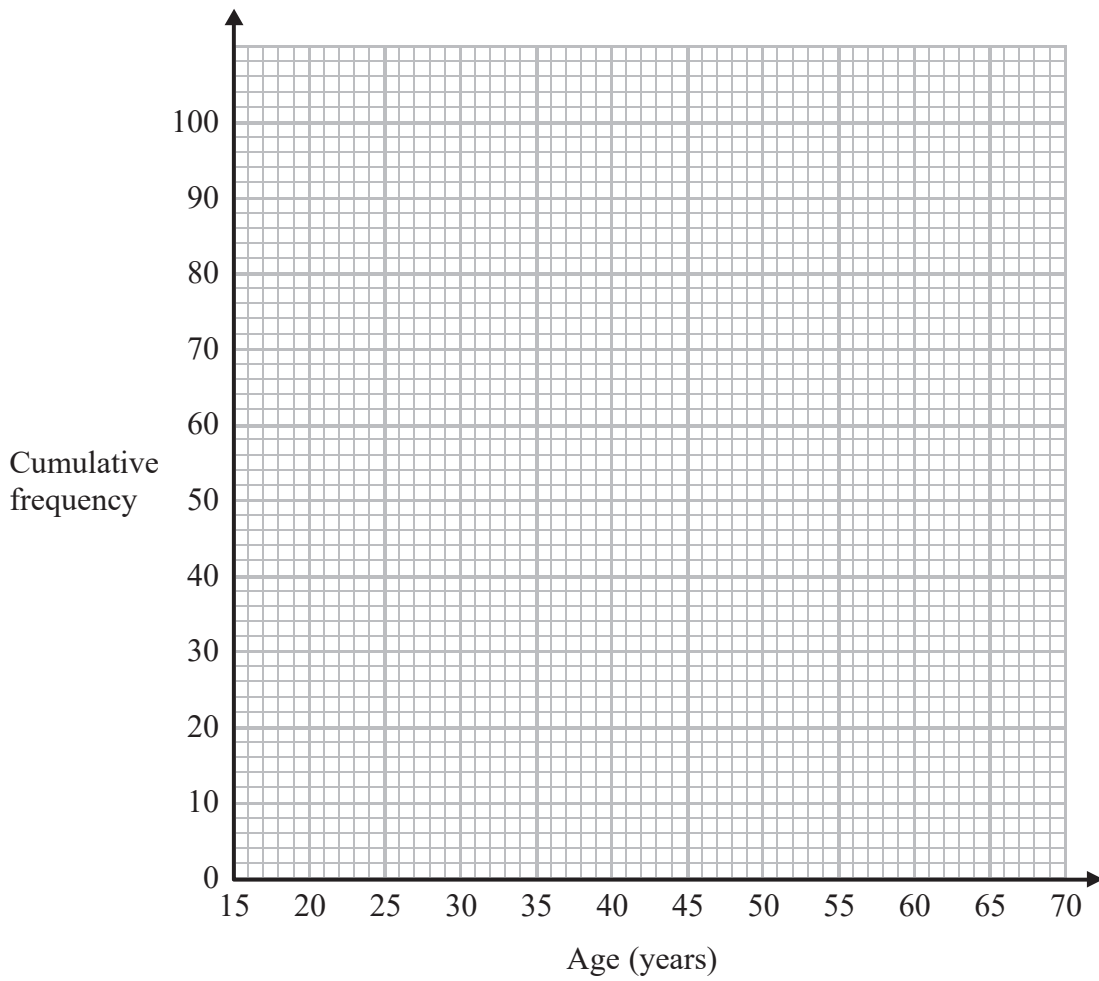

The total number of males aged under 65 working in Singapore in 2014 was 1 200 000

Using this information and your graph,

- (d) work out an estimate for the number of males working in Singapore in 2014 who were less than 52 years old.

.....  
(3)

**(Total for Question 12 is 8 marks)**



DO NOT WRITE IN THIS AREA

DO NOT WRITE IN THIS AREA

DO NOT WRITE IN THIS AREA

13 On the grid, show by shading the region defined by the inequalities

$$y > 5 \quad \text{and} \quad y < 2x + 1 \quad \text{and} \quad x + y < 10$$

Label your region **R**.

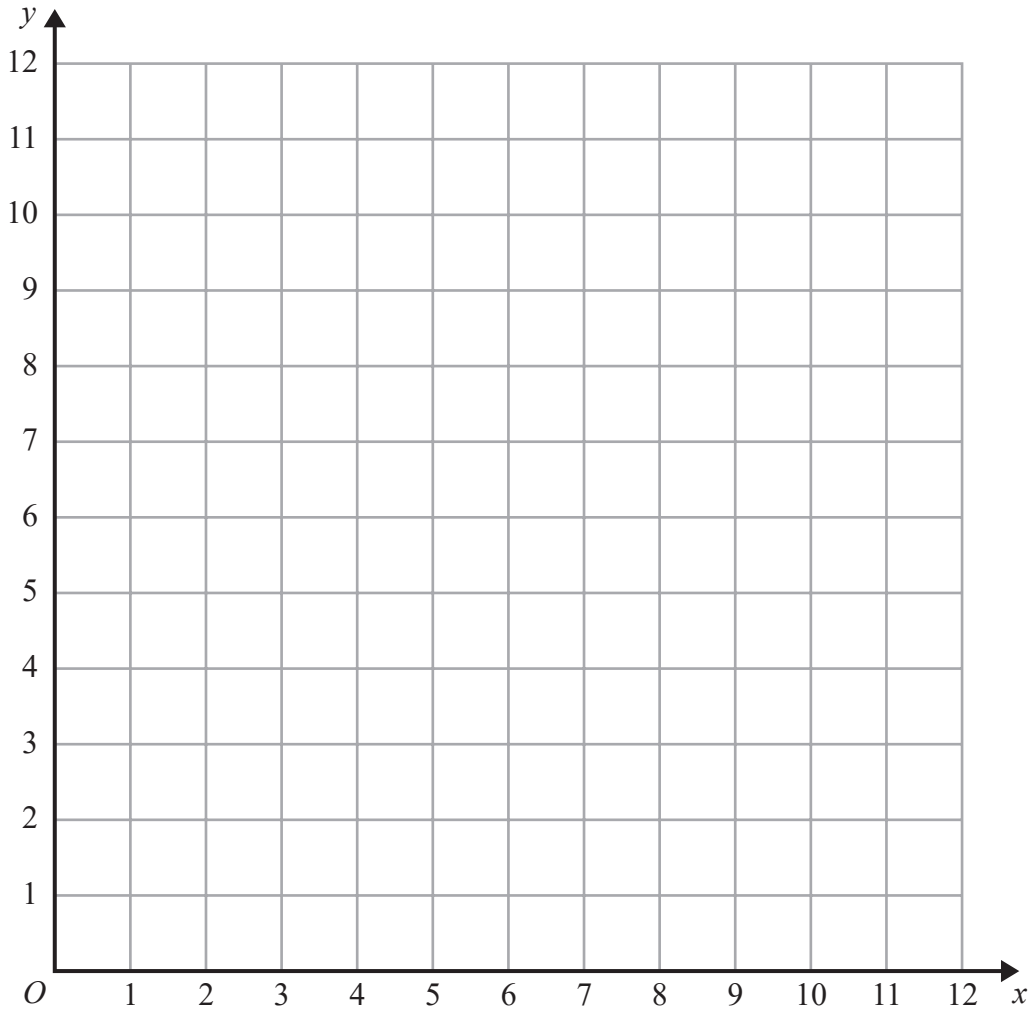

(Total for Question 13 is 3 marks)

DO NOT WRITE IN THIS AREA

DO NOT WRITE IN THIS AREA

DO NOT WRITE IN THIS AREA



- 14  $ABCDE$  is a regular pentagon with sides of length 10 cm.

Diagram **NOT**  
accurately drawn

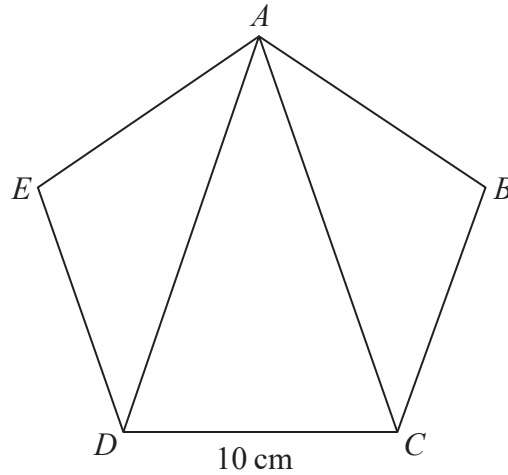

Calculate the area of triangle  $ACD$ .  
Give your answer correct to 3 significant figures.

.....cm<sup>2</sup>

(Total for Question 14 is 6 marks)

DO NOT WRITE IN THIS AREA

DO NOT WRITE IN THIS AREA

DO NOT WRITE IN THIS AREA



15 For the curve C with equation

$$y = 2x^3 - 3x^2 - 12x + 9$$

(a) find  $\frac{dy}{dx}$

.....  
(2)

(b) Find the gradient of C at the point with coordinates (2, -11)

.....  
(2)

The curve C has a gradient of -12 at the point where  $x = k$  and at the point where  $x = m$ .  
Given that  $k > m$

(c) find the value of  $k$  and the value of  $m$ .

$k =$  .....

$m =$  .....

(3)

(Total for Question 15 is 7 marks)

DO NOT WRITE IN THIS AREA

DO NOT WRITE IN THIS AREA

DO NOT WRITE IN THIS AREA





16 Make  $x$  the subject of the formula  $y = \frac{ax + b}{cx + d}$

DO NOT WRITE IN THIS AREA

DO NOT WRITE IN THIS AREA

DO NOT WRITE IN THIS AREA

.....  
(Total for Question 16 is 4 marks)



17

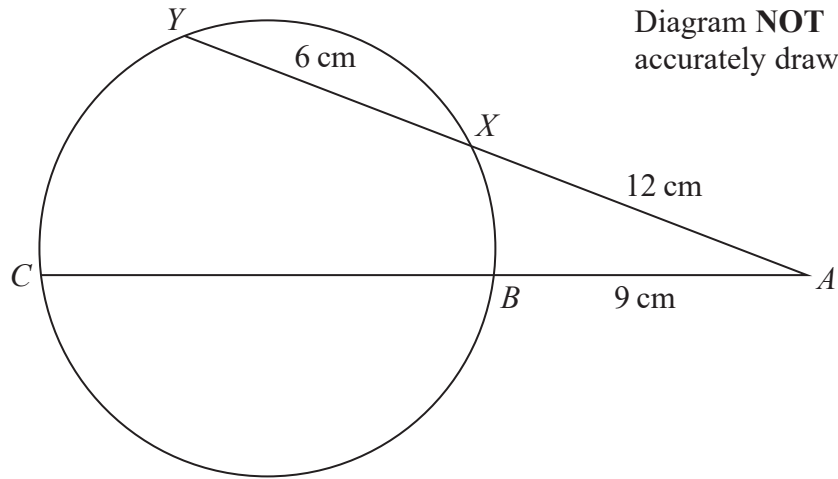

The points  $B$ ,  $C$ ,  $Y$  and  $X$  lie on a circle.  
 $AXY$  and  $ABC$  are straight lines.  
 $AX = 12 \text{ cm}$      $XY = 6 \text{ cm}$      $AB = 9 \text{ cm}$

Calculate the length of  $BC$ .

.....cm

(Total for Question 17 is 3 marks)

DO NOT WRITE IN THIS AREA

DO NOT WRITE IN THIS AREA

DO NOT WRITE IN THIS AREA



18 Solve the simultaneous equations

$$y^2 + 4x = 12$$

$$2x + 3y = 10$$

Show clear algebraic working.

DO NOT WRITE IN THIS AREA

DO NOT WRITE IN THIS AREA

DO NOT WRITE IN THIS AREA

(Total for Question 18 is 6 marks)



P 4 8 4 8 8 A 0 1 9 2 4

- 19 The diagram shows two solid shapes, shape **A** and shape **B**.  
 Shape **A** is made of a hemisphere and a cone.  
 Shape **B** is a cylinder.

**A**

Diagram **NOT**  
accurately drawn

**B**

For shape **A**

radius of the hemisphere is 36 cm  
 radius of the base of the cone is 36 cm  
 height of the cone is 53 cm

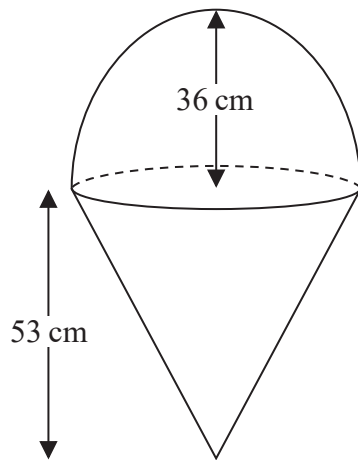
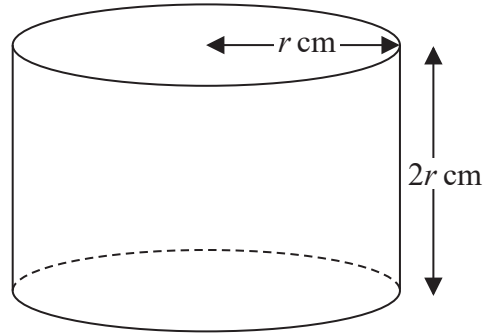
For shape **B**

radius of the cylinder is  $r$  cm  
 height of the cylinder is  $2r$  cm

The volume of shape **A** = the volume of shape **B**

Calculate the height of shape **B**.

DO NOT WRITE IN THIS AREA

DO NOT WRITE IN THIS AREA

DO NOT WRITE IN THIS AREA



DO NOT WRITE IN THIS AREA

DO NOT WRITE IN THIS AREA

DO NOT WRITE IN THIS AREA

.....cm

**(Total for Question 19 is 6 marks)**



P 4 8 4 8 8 A 0 2 1 2 4

20  $k = 2^p - 1$  where  $p$  is an integer  $> 1$

$$N = k^2 - 1$$

Show that  $2^{p+1}$  is a factor of  $N$

(Total for Question 20 is 3 marks)

DO NOT WRITE IN THIS AREA

DO NOT WRITE IN THIS AREA

DO NOT WRITE IN THIS AREA



21 Here is a shape  $ABCDE$ .

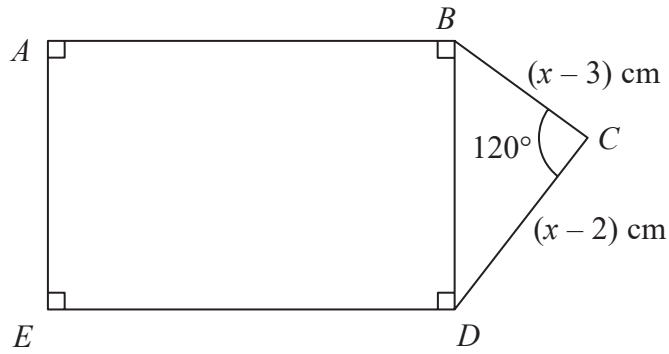

Diagram NOT  
accurately drawn

$ABDE$  is a rectangle in which  $AB = 2BD$

$BCD$  is a triangle in which angle  $BCD = 120^\circ$

$BC = (x - 3)$  cm       $CD = (x - 2)$  cm

The area of the rectangle  $ABDE$  is  $S$  cm<sup>2</sup>

Show that  $S$  can be expressed in the form  $S = ax^2 + bx + c$   
where  $a$ ,  $b$  and  $c$  are integers to be found.

$S = \dots\dots\dots$

(Total for Question 21 is 5 marks)

TOTAL FOR PAPER IS 100 MARKS



DO NOT WRITE IN THIS AREA

DO NOT WRITE IN THIS AREA

DO NOT WRITE IN THIS AREA

**BLANK PAGE**

**Do NOT write on this page**

