



Cambridge IGCSE™

COMBINED SCIENCE

0653/12

Paper 1 Multiple Choice (Core)

October/November 2021

45 minutes

You must answer on the multiple choice answer sheet.

You will need: Multiple choice answer sheet
Soft clean eraser
Soft pencil (type B or HB is recommended)

INSTRUCTIONS

- There are **forty** questions on this paper. Answer **all** questions.
- For each question there are four possible answers **A**, **B**, **C** and **D**. Choose the **one** you consider correct and record your choice in soft pencil on the multiple choice answer sheet.
- Follow the instructions on the multiple choice answer sheet.
- Write in soft pencil.
- Write your name, centre number and candidate number on the multiple choice answer sheet in the spaces provided unless this has been done for you.
- Do **not** use correction fluid.
- Do **not** write on any bar codes.
- You may use a calculator.

INFORMATION

- The total mark for this paper is 40.
- Each correct answer will score one mark.
- Any rough working should be done on this question paper.
- The Periodic Table is printed in the question paper.

This document has **20** pages. Any blank pages are indicated.



1 Movement is a characteristic of all living organisms.

Which two other characteristics of living organisms provide the energy for movement?

- A** excretion and nutrition
- B** growth and sensitivity
- C** nutrition and respiration
- D** respiration and growth

2 Which statement about diffusion is correct?

- A** It only happens through a partially permeable membrane.
- B** It only involves water molecules.
- C** It only occurs between living cells.
- D** It only occurs down a concentration gradient.

3 A biological molecule is analysed and found to contain carbon, oxygen, hydrogen and nitrogen.

What is this biological molecule?

- A** fat
- B** glucose
- C** protein
- D** starch

4 Which graph shows the effect of temperature on the activity of an enzyme from a human?

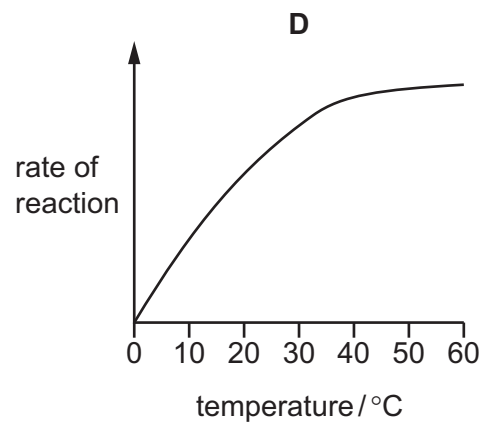
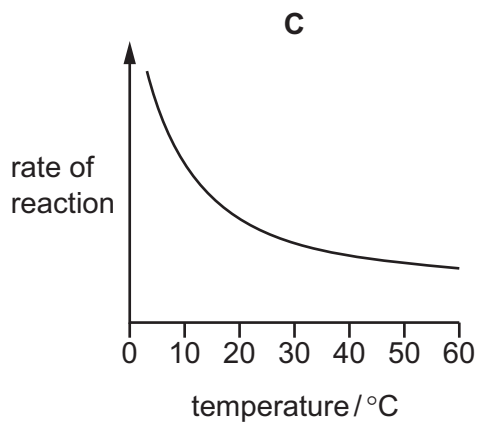
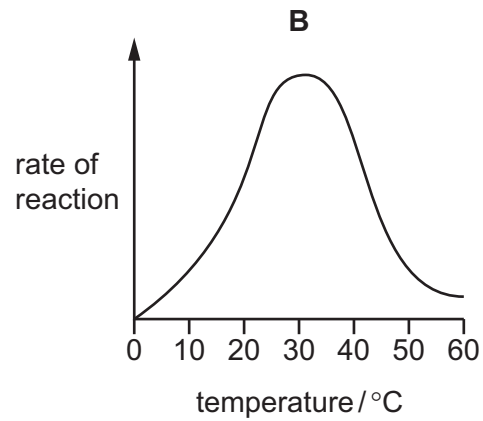
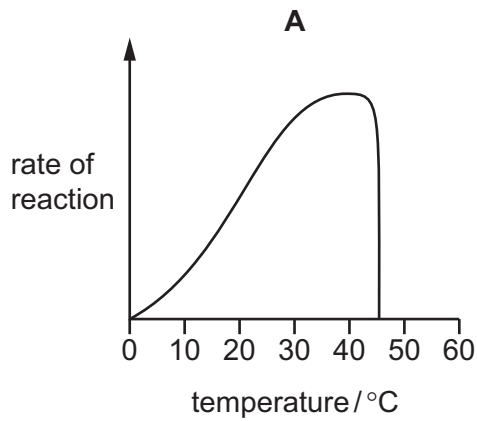

5 Which substance found in plant cells is needed for photosynthesis?

- A** chlorophyll
- B** glucose
- C** haemoglobin
- D** starch

6 Four nutrients are listed.

- 1 calcium
- 2 fat
- 3 fibre
- 4 iron

Milk and cheese are both good sources of two of these nutrients.

Which two nutrients?

- A** 1 and 2
- B** 1 and 4
- C** 2 and 3
- D** 3 and 4

7 What happens during digestion?

	large pieces of food are broken down into small pieces	large molecules are broken down into small molecules
A	✓	✓
B	✓	✗
C	✗	✓
D	✗	✗

8 Which vessel does oxygenated blood enter the heart through?

- A** aorta
- B** pulmonary artery
- C** pulmonary vein
- D** vena cava

9 The graph shows the rate and depth of breathing of a student at rest.

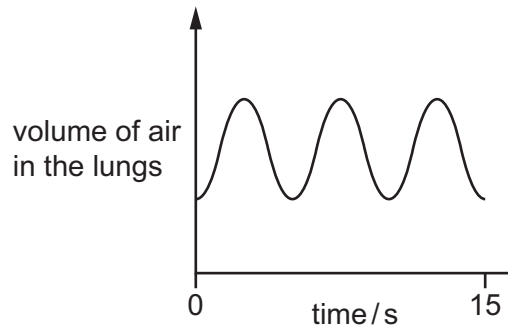

Which graph shows the rate and depth of breathing of the student immediately after five minutes of physical activity?

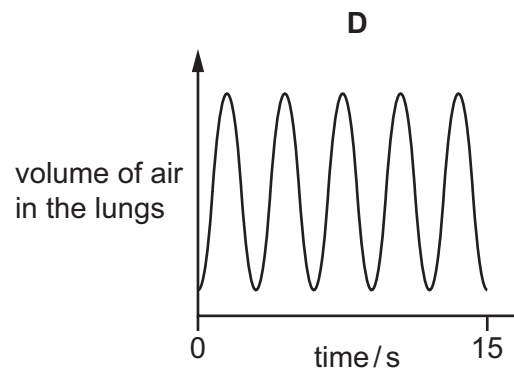
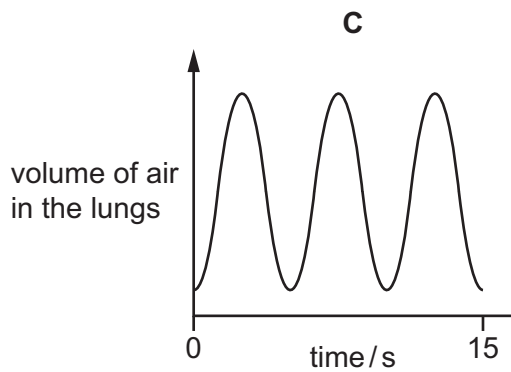
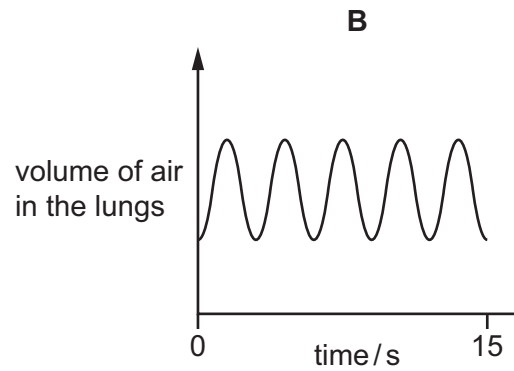
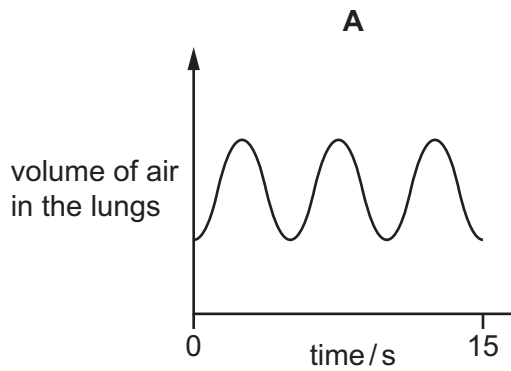

10 A student sets up an experiment to test the effect of phototropism on a seedling.

The student places the seedling in a box and only allows light through a small gap, as shown.

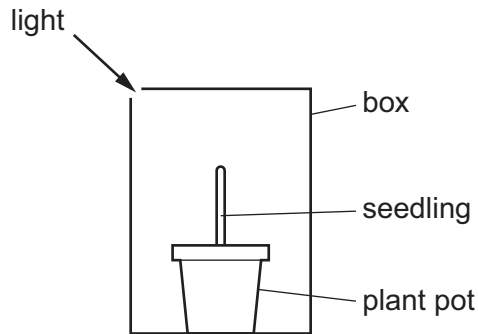

Which diagram shows the expected result of the experiment after two days?

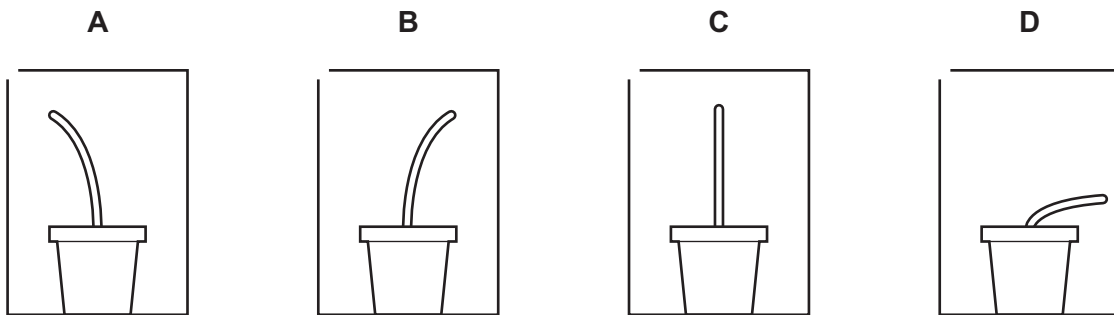

11 Which row is correct for sexual reproduction?

	gametes are formed	offspring genetically identical to parents
A	no	no
B	yes	no
C	no	yes
D	yes	yes

12 The diagram represents four organisms in a food chain.

$$T \rightarrow U \rightarrow V \rightarrow W$$

Which organisms are consumers?

- A** T, U and V **B** T, U and W **C** T, V and W **D** U, V and W

13 The diagram shows part of the carbon cycle.

Which stage in the cycle produces oxygen?

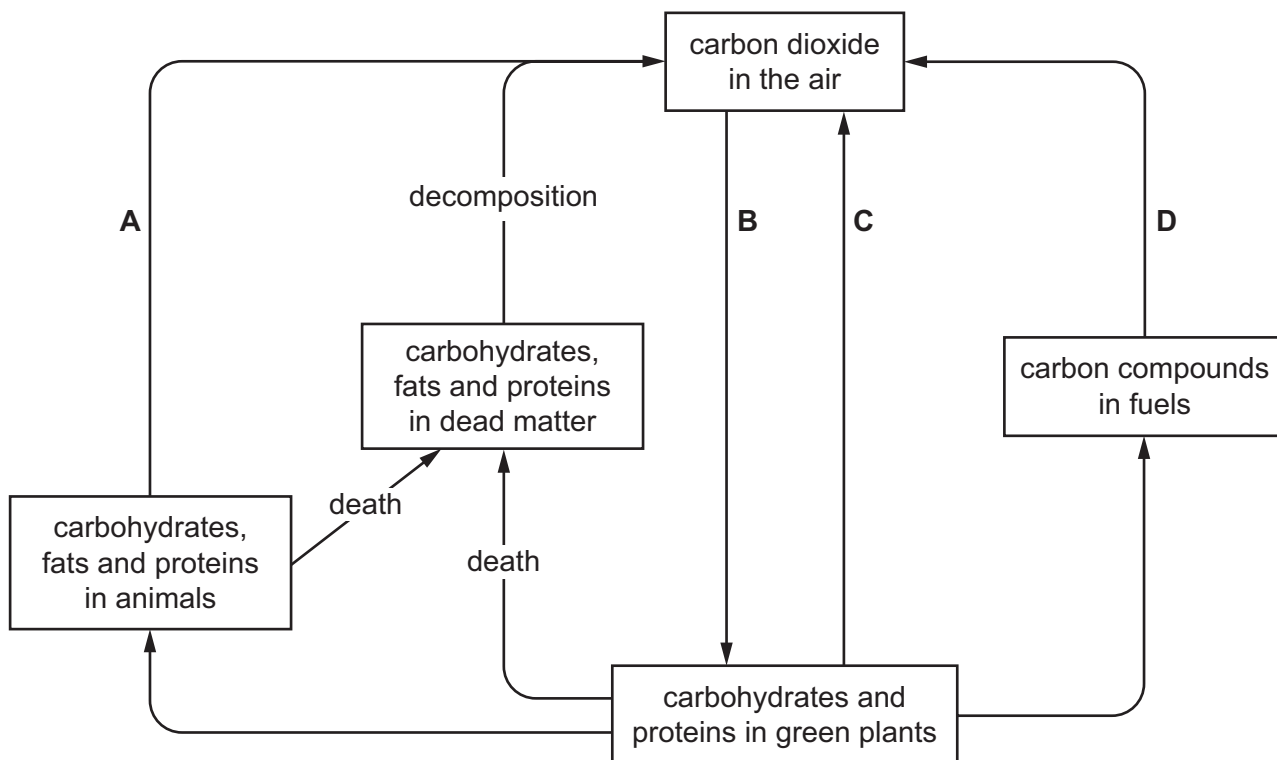

14 Which diagram shows a gas made up of molecules?

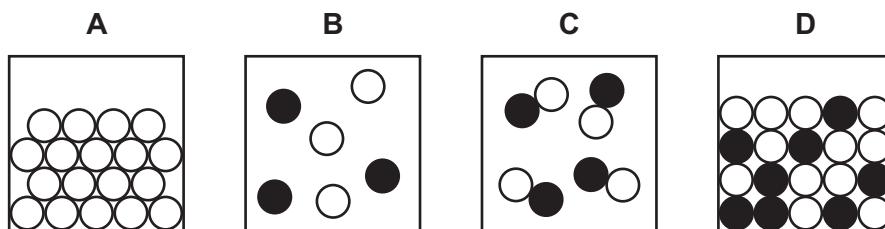

15 Which piece of apparatus is used to measure exactly 12.6 cm³ of dilute hydrochloric acid?

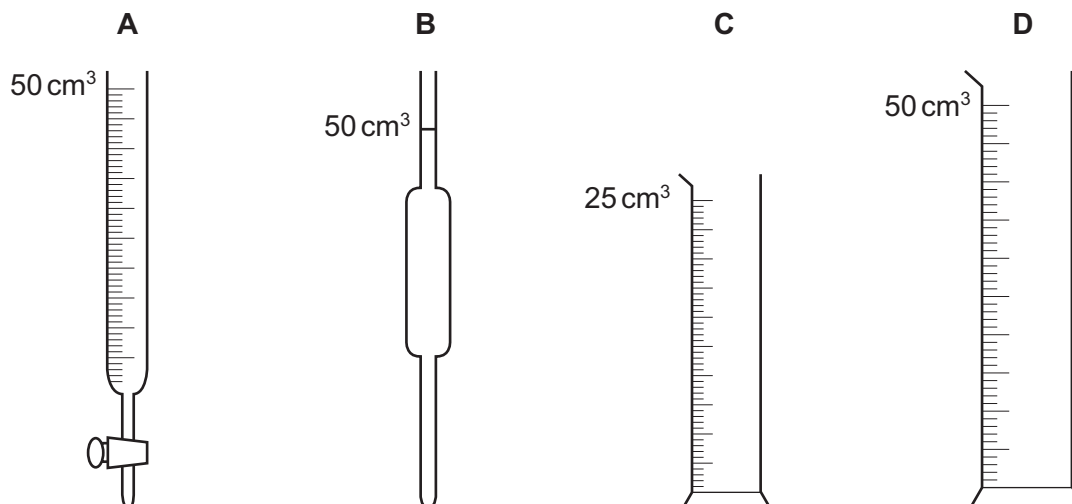

16 Which process is **not** a chemical change?

- A electrolysis of molten lead bromide
- B fractional distillation of petroleum
- C oxidation of copper
- D rusting of iron

17 The diagrams represent the particles in substances X, Y and Z.

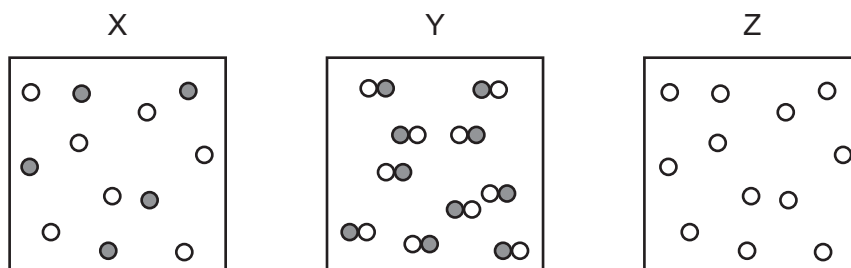

Which row identifies the element, the compound and the mixture?

	element	compound	mixture
A	X	Y	Z
B	X	Z	Y
C	Y	X	Z
D	Z	Y	X

18 The equation for the complete combustion of propane, C_3H_8 , is shown.

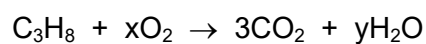

What are x and y?

	x	y
A	3	4
B	3	8
C	5	4
D	5	8

19 The electrolysis of dilute sulfuric acid is shown.

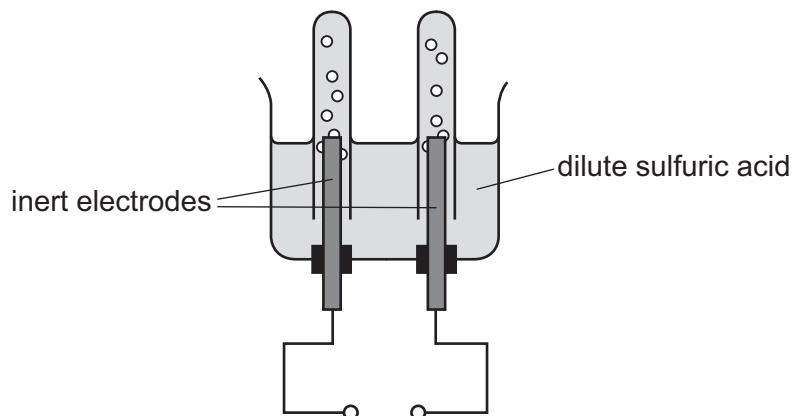

Which statement about this process is correct?

- A** Hydrogen is formed at the positive electrode.
- B** Oxygen is formed at the cathode.
- C** The inert electrodes are made from iron.
- D** More hydrogen is formed than oxygen.
- 20 The initial temperature of a sample of water is measured.
- Ammonium nitrate is mixed with the water. The final temperature is measured.
- The diagram shows the thermometer readings.

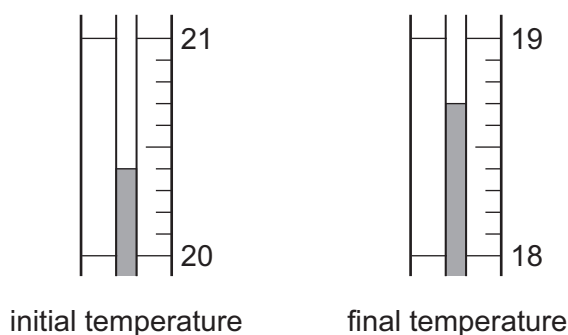

Which row shows the initial temperature, the final temperature and the type of reaction that occurs?

	initial temperature / °C	final temperature / °C	type of reaction
A	20.4	18.7	exothermic
B	21.6	19.3	exothermic
C	20.4	18.7	endothermic
D	21.6	19.3	endothermic

21 Hydrogen peroxide decomposes to form water and oxygen.

Which changes in temperature and in concentration **both** reduce the rate of this reaction?

	temperature of hydrogen peroxide	concentration of hydrogen peroxide
A	decrease	decrease
B	decrease	increase
C	increase	decrease
D	increase	increase

22 Ammonia dissolves in water.

Which test shows that the solution has a pH of 9?

- A** Blue litmus paper stays blue.
- B** Red litmus paper turns blue.
- C** Universal indicator paper turns green.
- D** Universal indicator paper turns blue.

23 A piece of damp blue litmus paper is placed in a gas.

The litmus paper turns red and then turns white.

What is the gas?

- A** carbon dioxide
- B** chlorine
- C** hydrogen
- D** oxygen

24 Which statement about transition elements is **not** correct?

- A** They can act as catalysts.
- B** They can be metals or non-metals.
- C** They have high densities.
- D** They have high melting points.

25 Brass is an alloy.

What is brass?

- A a compound containing two metallic elements
- B a compound containing two non-metallic elements
- C a mixture containing two metallic elements
- D a mixture containing two non-metallic elements

26 Magnesium carbonate reacts with dilute hydrochloric acid.

Calcium carbonate decomposes when heated.

Which gas is produced in **both** reactions?

- A carbon dioxide
- B carbon monoxide
- C chlorine
- D hydrogen

27 Substance X contains only single bonds.

Substance X burns in oxygen to form carbon dioxide and water.

What is substance X?

- A ethene
- B methane
- C carbon
- D propene

28 Which distance–time graph represents an object moving with decreasing speed?

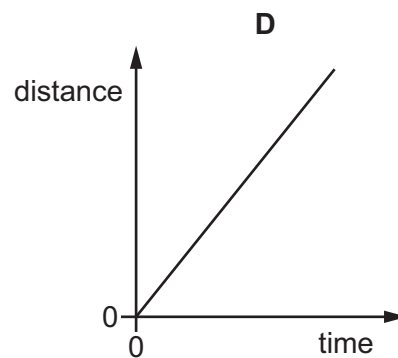
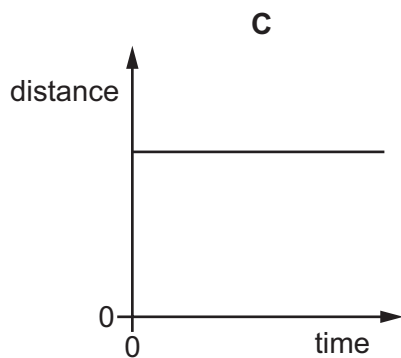
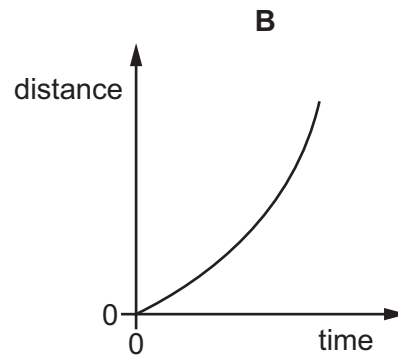
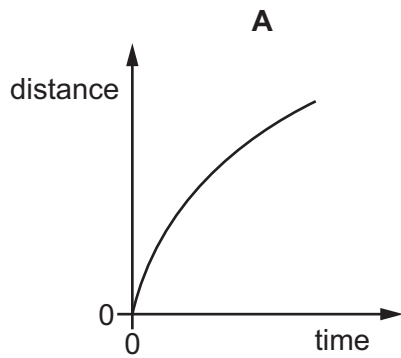

29 What is the unit for force and what is the unit for weight?

	force	weight
A	kg	kg
B	kg	N
C	N	kg
D	N	N

- 30 An empty measuring cylinder has a mass of 65 g. A liquid is poured into the cylinder to the level shown.

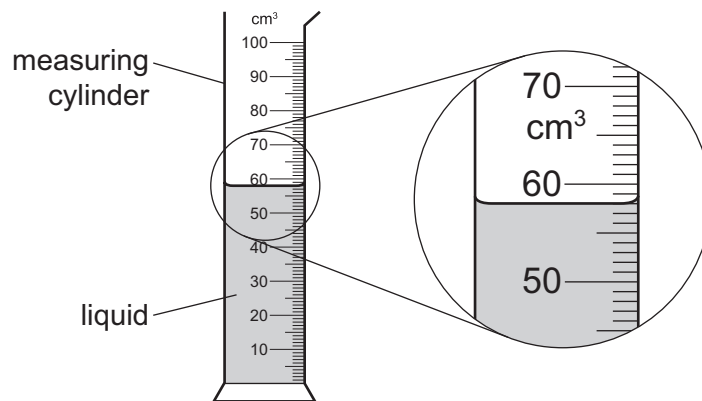

The mass of the measuring cylinder and liquid is now 120 g.

What is the density of the liquid?

- A** 0.89 g/cm^3 **B** 0.95 g/cm^3 **C** 1.1 g/cm^3 **D** 2.1 g/cm^3
- 31 Which two quantities are needed to calculate the work done by a force on an object?
- A** the size of the force and the acceleration of the object
B the size of the force and the distance travelled by the object in the direction of the force
C the size of the force and the mass of the object
D the size of the force and the time for which the force acts
- 32 What is the source of energy for a geothermal power station?
- A** heat from hot rocks in the Earth
B heat from sunlight striking the Earth
C heat produced by burning fossil fuels that are found in the Earth
D heat produced by friction as air moves over the surface of the Earth
- 33 Which statements about liquids and gases are correct?
- 1 Molecules in gases are further apart than molecules in liquids.
 - 2 Molecules in liquids and gases are arranged randomly.
 - 3 When a liquid evaporates, the temperature of the remaining liquid decreases.
- A** 1 and 2 only **B** 1 and 3 only **C** 2 and 3 only **D** 1, 2 and 3

34 What is the method of thermal energy transfer in a solid metal bar?

- A conduction
- B convection
- C evaporation
- D radiation

35 A ray of light passes through a glass window.

Which path does it take?

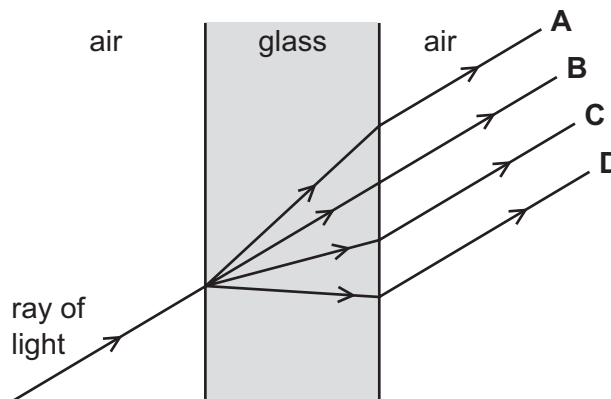

36 Elephants can hear sounds with frequencies between 10 Hz and 12 kHz.

Which frequency of sound can be heard by both elephants and humans with healthy ears?

- A 10 Hz
- B 15 Hz
- C 1500 Hz
- D 15 000 Hz

37 Two charged objects 1 and 2 are close to each other.

Which row describes the force between the objects for the charges shown?

	charge on object 1	charge on object 2	force
A	negative	negative	attraction
B	negative	positive	no force
C	positive	negative	attraction
D	positive	positive	no force

- 38 A circuit contains a battery connected to a resistor.

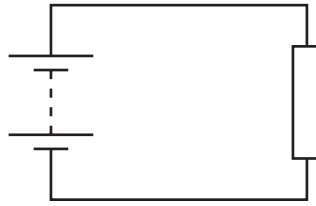

Which values of electromotive force (e.m.f.) and resistance produce the smallest current in the circuit?

	e.m.f./V	resistance/ Ω
A	6.0	10
B	6.0	20
C	24	80
D	24	160

- 39 The diagrams show four circuits, each containing an ammeter and two lamps with different resistances.

Which circuit shows an ammeter with a reading equal to the current in each lamp?

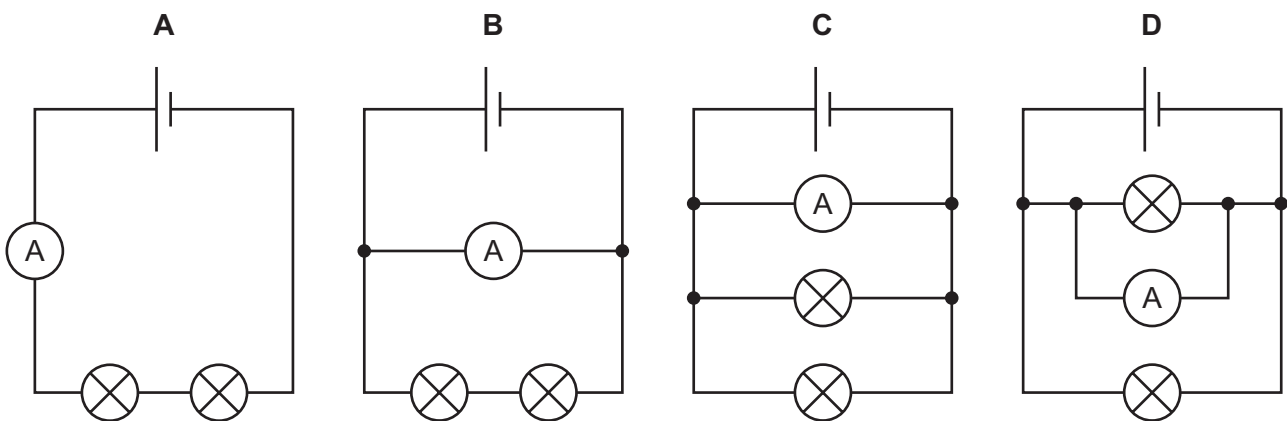

40 The diagram shows a circuit with four labelled components.

One component breaks the circuit automatically when the current becomes too large.

Which component does this?

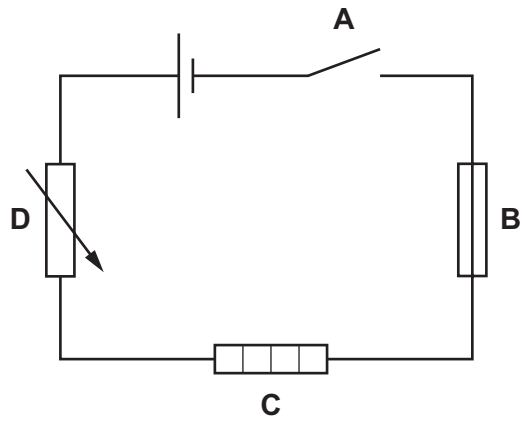

BLANK PAGE

BLANK PAGE

BLANK PAGE

Permission to reproduce items where third-party owned material protected by copyright is included has been sought and cleared where possible. Every reasonable effort has been made by the publisher (UCLES) to trace copyright holders, but if any items requiring clearance have unwittingly been included, the publisher will be pleased to make amends at the earliest possible opportunity.

To avoid the issue of disclosure of answer-related information to candidates, all copyright acknowledgements are reproduced online in the Cambridge Assessment International Education Copyright Acknowledgements Booklet. This is produced for each series of examinations and is freely available to download at www.cambridgeinternational.org after the live examination series.

Cambridge Assessment International Education is part of the Cambridge Assessment Group. Cambridge Assessment is the brand name of the University of Cambridge Local Examinations Syndicate (UCLES), which itself is a department of the University of Cambridge.

The Periodic Table of Elements

		Group								
I	II	III	IV	V	VI	VII	VIII			
3 Li lithium 7	4 Be beryllium 9	<div style="border: 1px solid black; padding: 5px; text-align: center;"> Key atomic number atomic symbol name relative atomic mass </div>						2 He helium 4		
11 Na sodium 23	12 Mg magnesium 24							5 B boron 11	6 C carbon 12	7 N nitrogen 14
19 K potassium 39	20 Ca calcium 40	13 Al aluminium 27	14 Si silicon 28	15 P phosphorus 31	16 S sulfur 32	17 Cl chlorine 35.5	18 Ar argon 40			
37 Rb rubidium 85	38 Sr strontium 88	31 Ga gallium 70	32 Ge germanium 73	33 As arsenic 75	34 Se selenium 79	35 Br bromine 80	36 Kr krypton 84			
55 Cs caesium 133	56 Ba barium 137	49 In indium 115	50 Sn tin 119	51 Sb antimony 122	52 Te tellurium 128	53 I iodine 127	54 Xe xenon 131			
87 Fr francium —	88 Ra radium —	81 Tl thallium 204	82 Pb lead 207	83 Bi bismuth 209	84 Po polonium —	85 At astatine —	86 Rn radon —			
		29 Cu copper 64	28 Ni nickel 59	27 Co cobalt 59	26 Fe iron 56	25 Mn manganese 55	24 Cr chromium 52	23 V vanadium 51	22 Ti titanium 48	
		47 Ag silver 108	46 Pd palladium 106	45 Rh rhodium 103	44 Ru ruthenium 101	43 Tc technetium —	42 Mo molybdenum 96	41 Nb niobium 93	40 Zr zirconium 91	
		79 Au gold 197	78 Pt platinum 195	77 Ir iridium 192	76 Os osmium 190	75 Re rhenium 186	74 W tungsten 184	73 Ta tantalum 181	72 Hf hafnium 178	
		111 Rg roentgenium —	110 Ds darmstadtium —	109 Mt meitnerium —	108 Hs hassium —	107 Bh bohrium —	106 Sg seaborgium —	105 Db dubnium —	104 Rf rutherfordium —	
		112 Cn copernicium —	111 Rg roentgenium —	110 Ds darmstadtium —	109 Mt meitnerium —	108 Hs hassium —	107 Bh bohrium —	106 Sg seaborgium —	105 Db dubnium —	
		114 Fl flerovium —	113 Nh nihonium —	112 Cn copernicium —	111 Rg roentgenium —	110 Ds darmstadtium —	109 Mt meitnerium —	108 Hs hassium —	107 Bh bohrium —	
		116 Lv livermorium —	115 Mc moscovium —	114 Cn copernicium —	113 Nh nihonium —	112 Cn copernicium —	111 Rg roentgenium —	110 Ds darmstadtium —	109 Mt meitnerium —	

lanthanoids	57 La lanthanum 139	58 Ce cerium 140	59 Pr praseodymium 141	60 Nd neodymium 144	61 Pm promethium —	62 Sm samarium 150	63 Eu europium 152	64 Gd gadolinium 157	65 Tb terbium 159	66 Dy dysprosium 163	67 Ho holmium 165	68 Er erbium 167	69 Tm thulium 169	70 Yb ytterbium 173	71 Lu lutetium 175
actinoids	89 Ac actinium —	90 Th thorium 232	91 Pa protactinium 231	92 U uranium 238	93 Np neptunium —	94 Pu plutonium —	95 Am americium —	96 Cm curium —	97 Bk berkelium —	98 Cf californium —	99 Es einsteinium —	100 Fm fermium —	101 Md mendelevium —	102 No nobelium —	103 Lr lawrencium —

The volume of one mole of any gas is 24 dm³ at room temperature and pressure (r.t.p.).