



Cambridge IGCSE™

CANDIDATE
NAME

CENTRE
NUMBER

--	--	--	--	--

CANDIDATE
NUMBER

--	--	--	--



COMBINED SCIENCE

0653/41

Paper 4 Theory (Extended)

October/November 2020

1 hour 15 minutes

You must answer on the question paper.

No additional materials are needed.

INSTRUCTIONS

- Answer **all** questions.
- Use a black or dark blue pen. You may use an HB pencil for any diagrams or graphs.
- Write your name, centre number and candidate number in the boxes at the top of the page.
- Write your answer to each question in the space provided.
- Do **not** use an erasable pen or correction fluid.
- Do **not** write on any bar codes.
- You may use a calculator.
- You should show all your working and use appropriate units.

INFORMATION

- The total mark for this paper is 80.
- The number of marks for each question or part question is shown in brackets [].
- The Periodic Table is printed in the question paper.

This document has **20** pages. Blank pages are indicated.

- 1 (a) Gas exchange takes place at the gas exchange surfaces of organisms.

Fig. 1.1 shows where gas exchange takes place in the lungs.

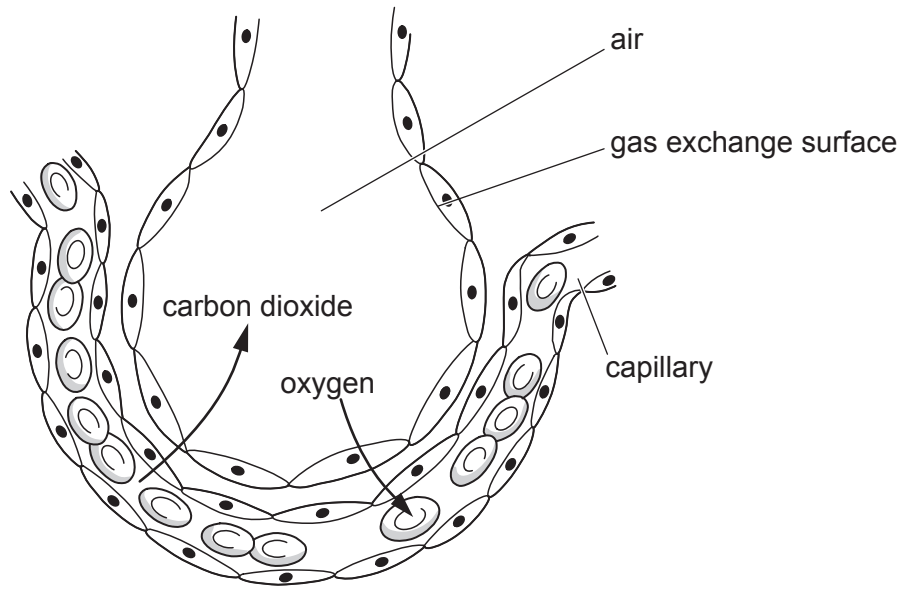

Fig. 1.1

- (i) Use Fig. 1.1 to describe what happens at a *gas exchange surface*.

.....
.....
..... [2]

- (ii) Name the gas exchange surface in the lungs.

..... [1]

- (iii) List **two** features of gas exchange surfaces.

1

2 [2]

(b) Fig. 1.2 shows a fetus inside a uterus.

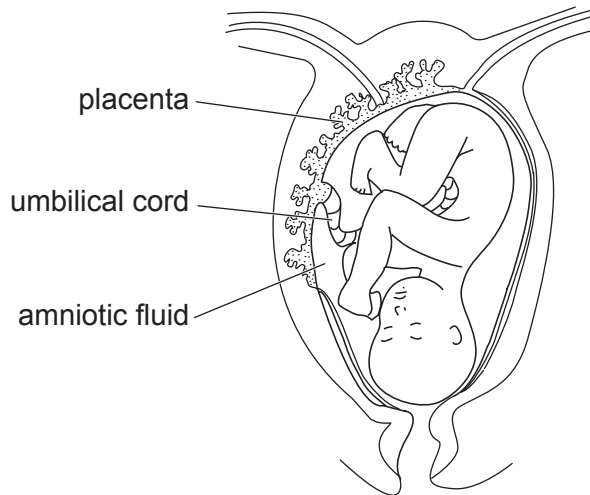

Fig. 1.2

(i) State the function of the umbilical cord.

.....
..... [1]

(ii) State the function of the amniotic fluid.

.....
..... [1]

(iii) Small molecules that are useful for the fetus diffuse across the placenta from the mother to the fetus.

Circle **two** small molecules which diffuse **from** the mother **to** the fetus.

- | | | |
|--------------------|-----------------------|---------------|
| amino acids | carbon dioxide | fats |
| glucose | glycogen | starch |

[2]

[Total: 9]

2 Fig. 2.1 is a simplified diagram of the fractional distillation of petroleum.

The formulae of three compounds contained in different fractions are shown.

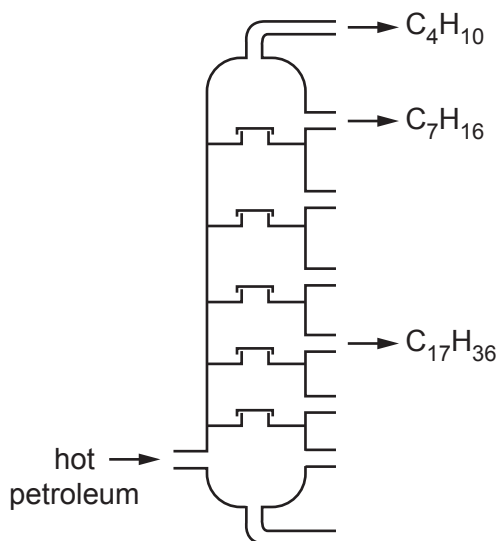

Fig. 2.1

(a) Describe the trend in the boiling points of the compounds C_4H_{10} , C_7H_{16} and $C_{17}H_{36}$.

Use ideas about the sizes of the molecules and the forces between the molecules to explain your answer.

trend

.....

explanation

.....

.....

..... [3]

(b) C_4H_{10} and C_7H_{16} are members of the homologous series of alkanes.

(i) Describe what is meant by a *homologous series*.

.....

.....

..... [2]

- (ii) Draw a dot-and-cross diagram to show the bonding in a molecule of carbon dioxide, CO_2 . Show only the outer shell electrons.

[2]

- (iii) Carbon dioxide is one of the products of the complete combustion of heptane, C_7H_{16} .

Complete and balance the symbol equation for the complete combustion of heptane, C_7H_{16} .

State symbols are **not** required.



[2]

- (c) Carbon dioxide is a greenhouse gas.

State **one** effect of an increase in the concentration of carbon dioxide in the atmosphere.

.....

.....

..... [1]

[Total: 10]

3 Fig. 3.1 shows a woman travelling on an escalator (a moving staircase).

The escalator moves the woman through a vertical distance of 9.0 m, from a lower level to a higher level.

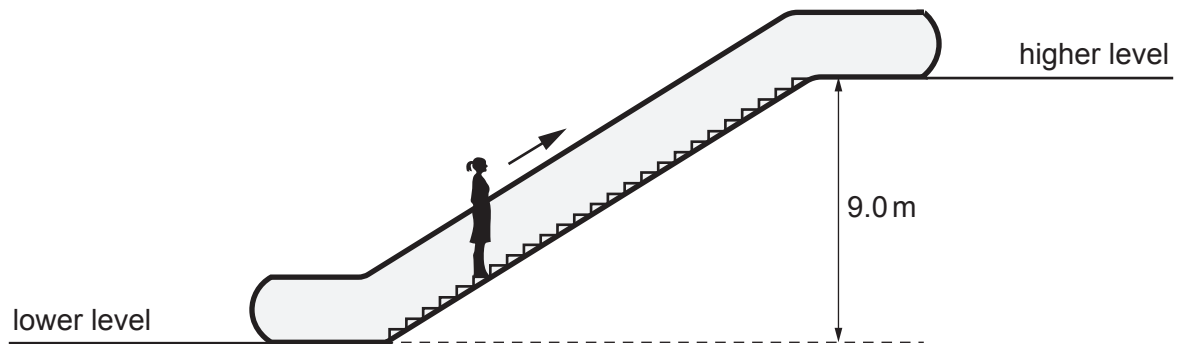

Fig. 3.1

(a) Fig. 3.2 shows a speed–time graph for the woman as:

- she walks on the lower level at a constant speed for 5.0 seconds
- she travels on the escalator at a constant speed for 20 seconds
- she steps off the escalator and walks away on the higher level.

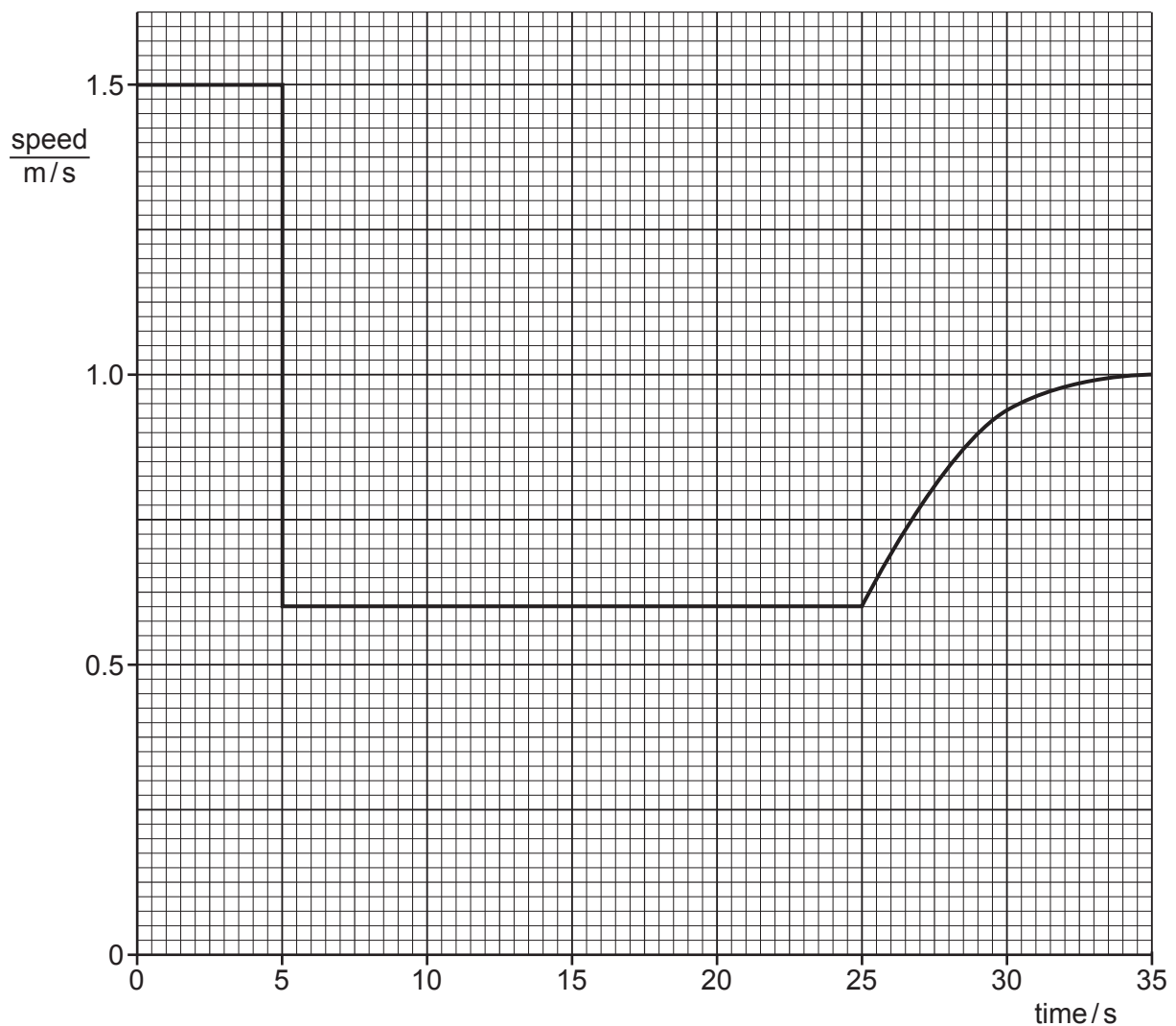

Fig. 3.2

- (i) Use Fig. 3.2 to calculate the distance the woman walks on the lower level.

distance = m [3]

- (ii) Use Fig. 3.2 to state the time at which the woman steps off the escalator.

time = s [1]

- (iii) On Fig. 3.2, draw an **X** on the graph to show when the woman is moving with acceleration that is **not** constant. [1]

- (b) The woman has a weight of 600 N.

- (i) Calculate the change in gravitational potential energy ($\Delta G.P.E.$) of the woman in moving through the vertical distance of 9.0 m.

$\Delta G.P.E.$ = J [2]

- (ii) The electric motor for the escalator has a power of 48 kW.

Calculate the energy supplied by the electric motor in the 20 seconds the woman travels on the escalator.

energy supplied = J [3]

- (iii) Suggest **two** reasons why the answer to (b)(ii) is much greater than the answer to (b)(i).

1

2

[2]

[Total: 12]

4 Fig. 4.1 shows an external view of the heart.

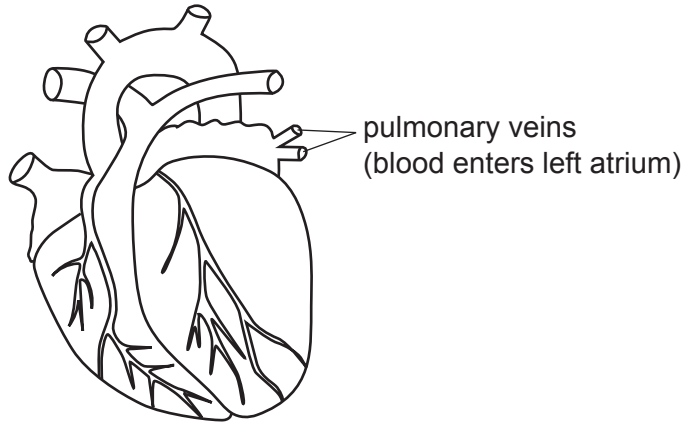

Fig. 4.1

(a) On Fig. 4.1, use a label line and the letter **C** to identify a coronary artery. [1]

(b) Name the substance in red blood cells that carries oxygen.
..... [1]

(c) The heart rate increases during exercise causing the blood to flow more quickly.
Explain why the heart rate increases during exercise.
.....
.....
.....
.....
.....
..... [3]

(d) (i) Hormones are transported in blood plasma.
Define a *hormone*.
.....
..... [2]

(ii) Name the hormone that causes an increase in heart rate.
..... [1]

[Total: 8]

- 5 (a) Sodium reacts with water to form aqueous sodium hydroxide, NaOH, and hydrogen gas.
 (i) This reaction is exothermic.

Fig. 5.1 is an energy level diagram for the reaction.

On Fig. 5.1, label the energy level diagram to show the *reactants*, the *products* and the *activation energy*.

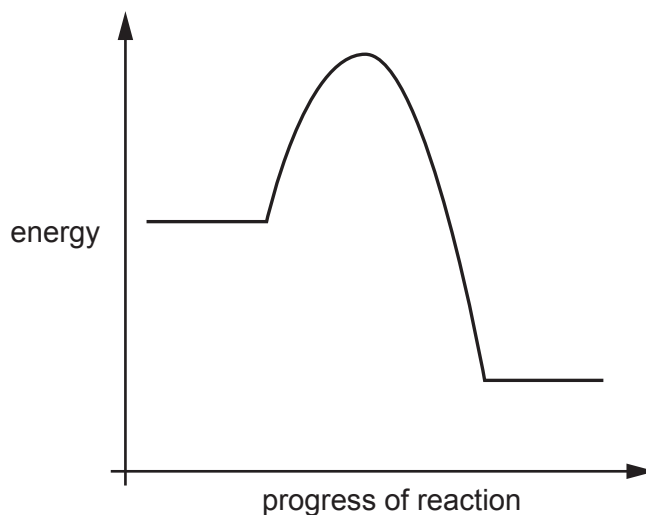

Fig. 5.1

[2]

- (ii) During the reaction, the sodium melts.

Describe, in terms of particle bonds and energy, what happens when sodium melts.

.....

 [2]

- (iii) Suggest the pH of the aqueous sodium hydroxide.

Give a reason for your answer.

pH

reason

..... [1]

- (iv) State the formulae of the two ions present in sodium hydroxide.

..... and [1]

(b) Explain why sodium must **not** be added to dilute hydrochloric acid.

.....
..... [1]

(c) Sodium is extracted from molten sodium chloride by electrolysis.

Sodium is formed at the cathode.

Name the product formed at the anode.

..... [1]

(d) Sodium is an element in Period 3 of the Periodic Table.

Describe the relationship between the number of outer shell electrons and the metallic character of elements across a period.

.....
..... [1]

[Total: 9]

- 6 Fig. 6.1 shows a girl using a bicycle pump to 'pump up' (add air to) a bicycle tyre.

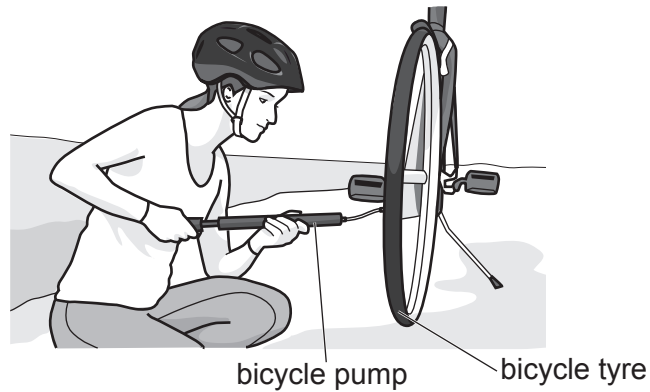

Fig. 6.1

- (a) After pumping up the tyre, the pressure of the air inside the tyre is greater than the pressure of the air outside the tyre.

Describe how the distances between the molecules in the air are different inside the tyre and outside the tyre.

.....
 [1]

- (b) The pressure of the air inside the bicycle tyre is $3.0 \times 10^5 \text{ N/m}^2$.

The total surface area of the inside wall of the bicycle tyre is 0.25 m^2 .

Calculate the total force exerted by the air inside the bicycle tyre on the inside wall of the tyre.

force = N [2]

(c) Fig. 6.2 shows the structure of the girl's bicycle helmet.

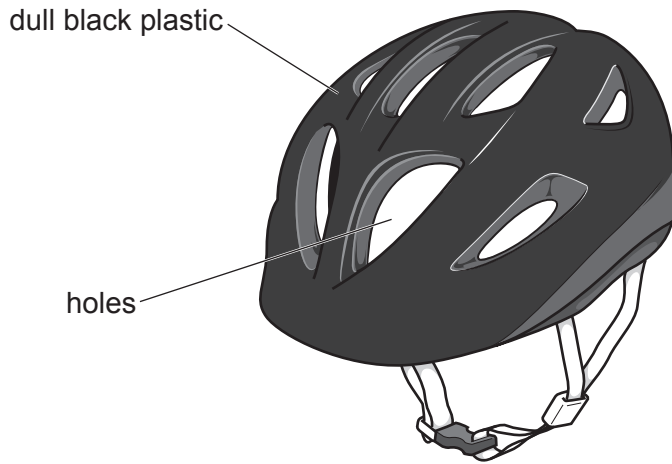

Fig. 6.2

(i) When the girl is cycling, her head gets hot. The skin on her head sweats.

Suggest how the structure of the helmet helps the sweat on her head to evaporate.

.....
.....
..... [2]

(ii) Suggest a change to the appearance of the helmet that would reduce the amount of radiation absorbed by the helmet.

Give a reason for your answer.

.....
.....
..... [2]

(d) Fig. 6.3 shows a bell on the handlebars of the bicycle.

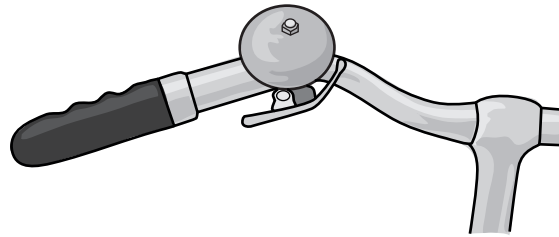

Fig. 6.3

When the girl rings the bell, it emits sound waves of frequency 1320 Hz.

The speed of sound in air is 330 m/s.

Calculate the wavelength of the sound waves emitted.

wavelength = m [2]

[Total: 9]

7 During sexual reproduction in flowering plants, both pollination and fertilisation take place.

(a) Describe fertilisation in a flower.

.....

.....

..... [2]

(b) Fig. 7.1 shows a diagram of a wind-pollinated flower **X** and a diagram of an insect-pollinated flower **Y**.

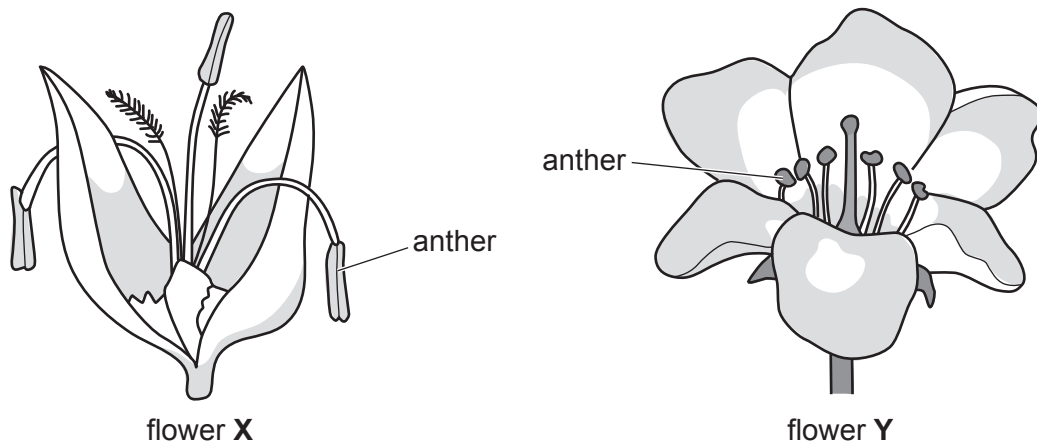

Fig. 7.1

(i) Describe how the anthers of **X** are adapted for wind pollination.

.....

.....

..... [2]

(ii) Give **two** pieces of evidence in Fig. 7.1 that show that **Y** is an insect-pollinated flower.

1

2

[2]

(c) Explain why flowering plants are called *producers*.

.....

.....

..... [2]

(d) Producers are the first trophic level of every food chain.

Explain why food chains usually have fewer than five trophic levels.

.....
.....
..... [2]

[Total: 10]

8 Copper chloride is produced when dilute hydrochloric acid reacts with copper carbonate.

(a) State **one** other substance that reacts with dilute hydrochloric acid to produce copper chloride.

..... [1]

(b) Copper is a transition element. Potassium is a Group I element.

(i) State **one** property of copper that is also a property of potassium.

.....
..... [1]

(ii) State **one** property of copper compounds that is **not** a property of potassium compounds.

.....
..... [1]

(c) Copper is extracted by heating copper oxide with carbon.

A redox reaction occurs.

The equation for this reaction is shown.



Explain, in detail, why this reaction is a *redox reaction*.

.....
.....
.....
..... [3]

(d) Fig. 8.1 shows the arrangement of copper atoms and zinc atoms in a sample of brass.

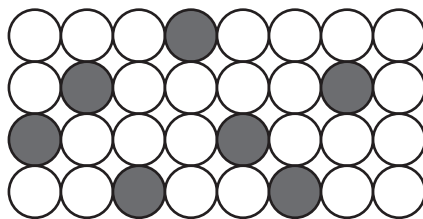

Key



Fig. 8.1

Circle words from the list that can be used to describe brass.

alloy

compound

element

mixture

molecule

[1]

[Total: 7]

9 Fig. 9.1 shows an electric lawnmower that is used for cutting grass.



Fig. 9.1

The lawnmower operates from a 230V mains electricity supply.

The circuit in the lawnmower contains:

- an electric motor
- a switch to switch the motor on and off
- a lamp to show when the motor is switched on
- a variable resistor to vary the current in the motor but not the current in the lamp
- a fuse to protect the circuit.

(a) On Fig. 9.2, complete the circuit diagram for the lawnmower.

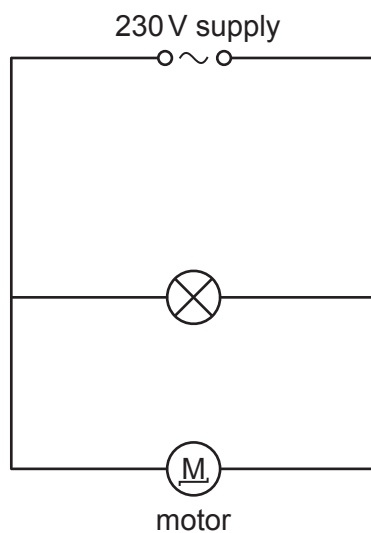

Fig. 9.2

[4]

(b) The current in the lamp is 0.25 A.

The potential difference across the lamp is 230 V.

Calculate the resistance of the lamp.

resistance = Ω [2]

[Total: 6]

Permission to reproduce items where third-party owned material protected by copyright is included has been sought and cleared where possible. Every reasonable effort has been made by the publisher (UCLES) to trace copyright holders, but if any items requiring clearance have unwittingly been included, the publisher will be pleased to make amends at the earliest possible opportunity.

To avoid the issue of disclosure of answer-related information to candidates, all copyright acknowledgements are reproduced online in the Cambridge Assessment International Education Copyright Acknowledgements Booklet. This is produced for each series of examinations and is freely available to download at www.cambridgeinternational.org after the live examination series.

Cambridge Assessment International Education is part of the Cambridge Assessment Group. Cambridge Assessment is the brand name of the University of Cambridge Local Examinations Syndicate (UCLES), which itself is a department of the University of Cambridge.

The Periodic Table of Elements

Group																				
I	II	III	IV	V	VI	VII	VIII													
3 Li lithium 7	4 Be beryllium 9	1 H hydrogen 1	5 B boron 11	6 C carbon 12	7 N nitrogen 14	8 O oxygen 16	9 F fluorine 19	10 Ne neon 20												
11 Na sodium 23	12 Mg magnesium 24	Key atomic number atomic symbol name relative atomic mass		13 Al aluminium 27	14 Si silicon 28	15 P phosphorus 31	16 S sulfur 32	17 Cl chlorine 35.5	18 Ar argon 40											
19 K potassium 39	20 Ca calcium 40	21 Sc scandium 45	22 Ti titanium 48	23 V vanadium 51	24 Cr chromium 52	25 Mn manganese 55	26 Fe iron 56	27 Co cobalt 59	28 Ni nickel 59	29 Cu copper 64	30 Zn zinc 65	31 Ga gallium 70	32 Ge germanium 73	33 As arsenic 75	34 Se selenium 79	35 Br bromine 80	36 Kr krypton 84			
37 Rb rubidium 85	38 Sr strontium 88	39 Y yttrium 89	40 Zr zirconium 91	41 Nb niobium 93	42 Mo molybdenum 96	43 Tc technetium —	44 Ru ruthenium 101	45 Rh rhodium 103	46 Pd palladium 106	47 Ag silver 108	48 Cd cadmium 112	49 In indium 115	50 Sn tin 119	51 Sb antimony 122	52 Te tellurium 128	53 I iodine 127	54 Xe xenon 131			
55 Cs caesium 133	56 Ba barium 137	57–71 lanthanoids	72 Hf hafnium 178	73 Ta tantalum 181	74 W tungsten 184	75 Re rhenium 186	76 Os osmium 190	77 Ir iridium 192	78 Pt platinum 195	79 Au gold 197	80 Hg mercury 201	81 Tl thallium 204	82 Pb lead 207	83 Bi bismuth 209	84 Po polonium —	85 At astatine —	86 Rn radon —			
87 Fr francium —	88 Ra radium —	89–103 actinoids	104 Rf rutherfordium —	105 Db dubnium —	106 Sg seaborgium —	107 Bh bohrium —	108 Hs hassium —	109 Mt meitnerium —	110 Ds darmstadtium —	111 Rg roentgenium —	112 Cn copernicium —	114 Fl flerovium —	116 Lv livermorium —							

57 La lanthanum 139	58 Ce cerium 140	59 Pr praseodymium 141	60 Nd neodymium 144	61 Pm promethium —	62 Sm samarium 150	63 Eu europium 152	64 Gd gadolinium 157	65 Tb terbium 159	66 Dy dysprosium 163	67 Ho holmium 165	68 Er erbium 167	69 Tm thulium 169	70 Yb ytterbium 173	71 Lu lutetium 175
89 Ac actinium —	90 Th thorium 232	91 Pa protactinium 231	92 U uranium 238	93 Np neptunium —	94 Pu plutonium —	95 Am americium —	96 Cm curium —	97 Bk berkelium —	98 Cf californium —	99 Es einsteinium —	100 Fm fermium —	101 Md mendelevium —	102 No nobelium —	103 Lr lawrencium —

lanthanoids

actinoids

The volume of one mole of any gas is 24 dm³ at room temperature and pressure (r.t.p.).