



**Cambridge International Examinations**  
Cambridge International General Certificate of Secondary Education

**COMBINED SCIENCE**

**0653/23**

Paper 2 Multiple Choice (Extended)

**October/November 2018**

**45 minutes**

Additional Materials: Multiple Choice Answer Sheet  
Soft clean eraser  
Soft pencil (type B or HB is recommended)

\* 1 6 1 8 4 8 2 9 8 7 \*

**READ THESE INSTRUCTIONS FIRST**

Write in soft pencil.

Do not use staples, paper clips, glue or correction fluid.

Write your name, Centre number and candidate number on the Answer Sheet in the spaces provided unless this has been done for you.

**DO NOT WRITE IN ANY BARCODES.**

There are **forty** questions on this paper. Answer **all** questions. For each question there are four possible answers **A, B, C** and **D**.

Choose the **one** you consider correct and record your choice in **soft pencil** on the separate Answer Sheet.

**Read the instructions on the Answer Sheet very carefully.**

Each correct answer will score one mark. A mark will not be deducted for a wrong answer.

Any rough working should be done in this booklet.

A copy of the Periodic Table is printed on page 16.

Electronic calculators may be used.

This document consists of **16** printed pages.

1 The diagram shows a typical plant cell.

Which part of the cell contains the genetic information of the cell?

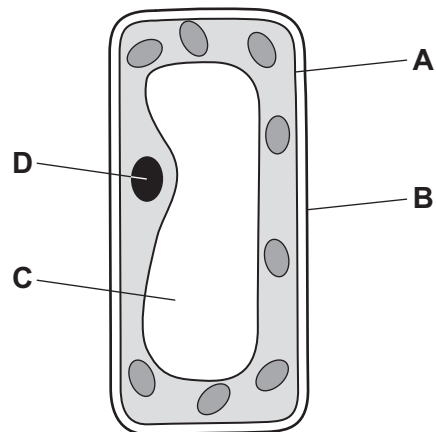

2 Which process depends on diffusion?

- A circulation
- B digestion
- C gaseous exchange
- D phagocytosis

- 3 A human enzyme breaks down starch into simple sugars.

A solution of this human enzyme was heated to 90 °C for 30 minutes.

2 cm<sup>3</sup> of this human enzyme solution was added to starch solution in several different test-tubes. The test-tubes were kept at different temperatures for 15 minutes.

Which graph shows the amount of sugar produced in the test-tubes?

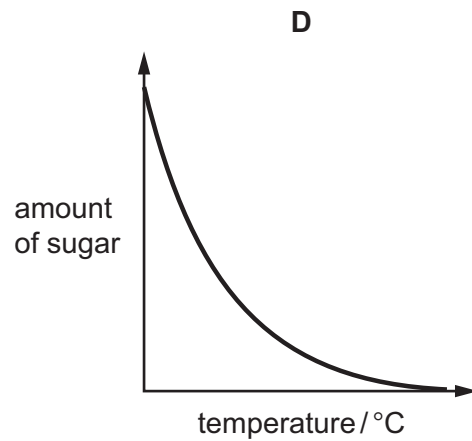
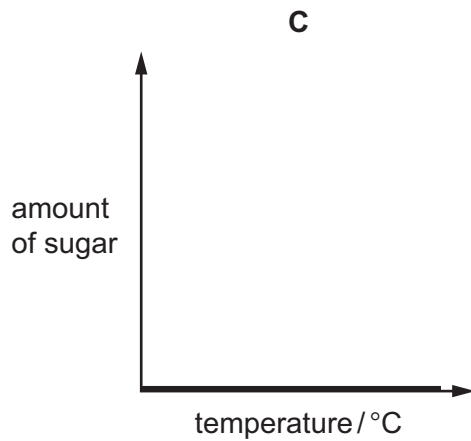
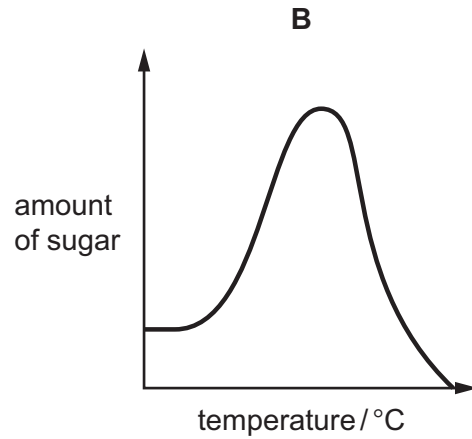
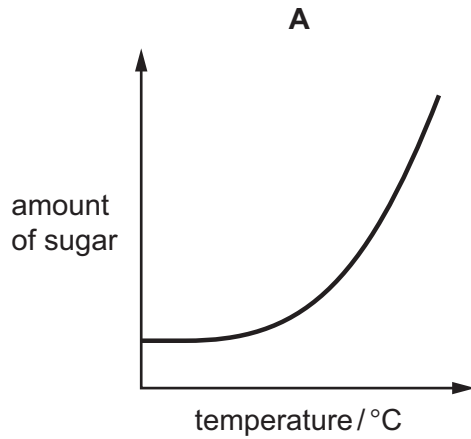

- 4 The diagram shows a leaf that was tested for starch using iodine solution.

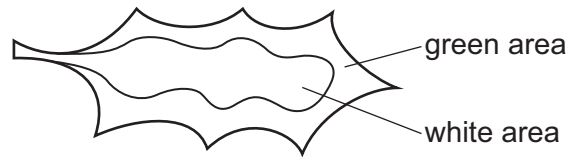

Which row shows the results for this leaf and explains the results?

	green area of leaf after test	white area of leaf after test	explanation
<b>A</b>	blue-black	blue-black	chlorophyll is found in all parts of the leaf
<b>B</b>	blue-black	brown	chlorophyll is found in only part of the leaf
<b>C</b>	brown	brown	chlorophyll is found in all parts of the leaf
<b>D</b>	brown	blue-black	chlorophyll is found in only part of the leaf

- 5 A doctor advises a man to change his diet and reduce his intake of saturated fat and salt.

Which condition is the man most likely to be suffering from?

- A** constipation
  - B** coronary heart disease
  - C** dental decay
  - D** starvation
- 6 The diagram shows a cross-section of a root hair cell.

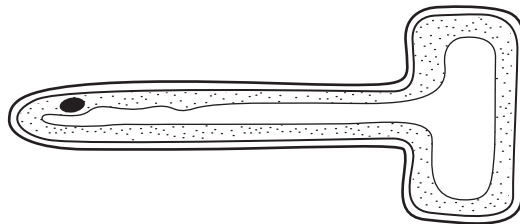

Which row describes the root hair cell and its function?

	animal cell or plant cell	function
<b>A</b>	animal cell	water and glucose uptake
<b>B</b>	animal cell	water and ion uptake
<b>C</b>	plant cell	water and glucose uptake
<b>D</b>	plant cell	water and ion uptake

7 Which blood vessel contains blood at the highest pressure?

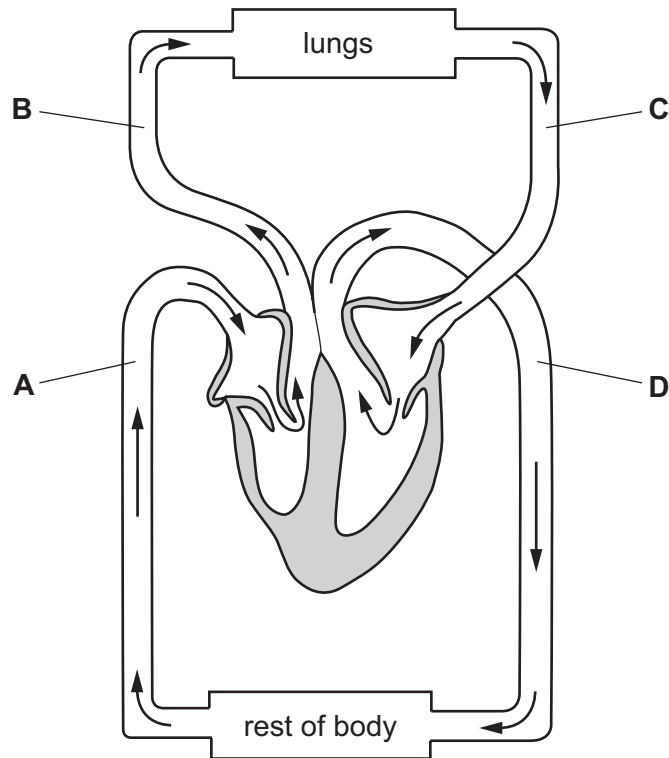

8 The diagram shows two different types of cell which line the trachea in the gas exchange system.

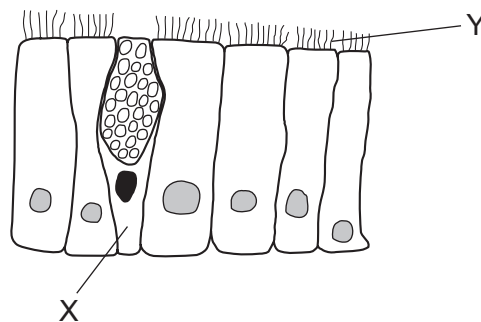

What is the role of X and Y?

	X	Y
<b>A</b>	produces mucus	traps pathogens
<b>B</b>	produces mucus	moves pathogens towards the mouth
<b>C</b>	moves pathogens towards the mouth	traps pathogens
<b>D</b>	moves pathogens towards the mouth	moves pathogens towards the mouth

9 Which statement about adrenaline is **not** correct?

- A It decreases blood glucose concentration.
- B It is carried by the blood.
- C It is produced by a gland.
- D The heart is one of its target organs.

10 In an investigation, four test-tubes containing seeds were set up as shown in the diagram.

After several days, which test-tube will contain the most germinated seeds?

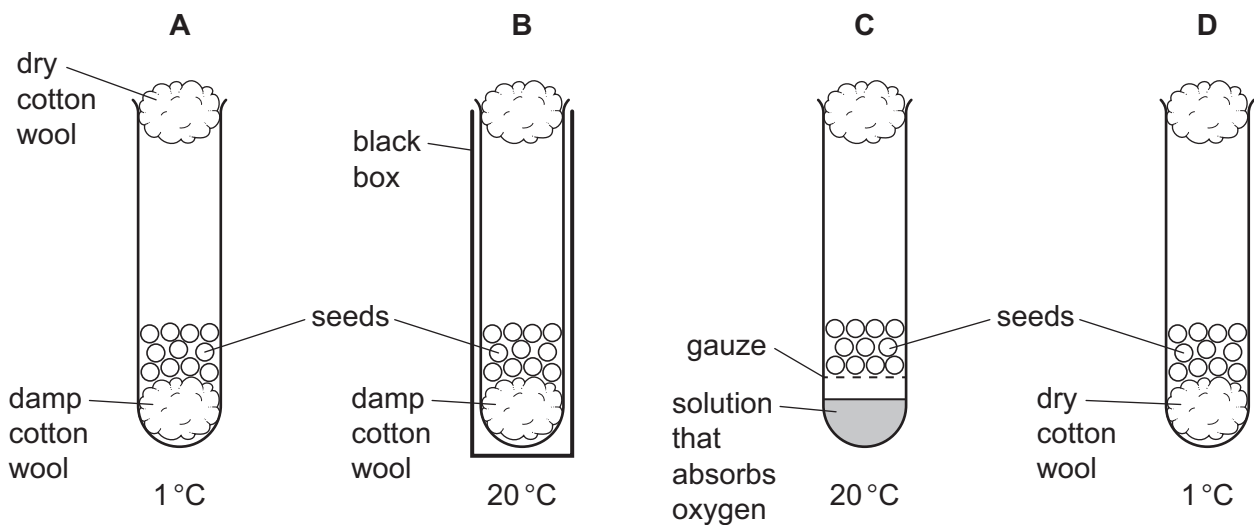

11 During pregnancy in humans, gas exchange occurs between a mother and her fetus.

Where does this gas exchange occur?

- A amniotic fluid
- B amniotic sac
- C placenta
- D umbilical cord

12 What is the definition of a trophic level?

- A It shows how an organism loses energy.
- B It shows the position of an organism in a food chain.
- C It shows the consumers of an organism.
- D It shows the food eaten by an organism.

13 Which are possible harmful effects of deforestation?

	global warming	species extinction
<b>A</b>	✓	✓
<b>B</b>	✓	x
<b>C</b>	x	✓
<b>D</b>	x	x

14 Sucrose is a covalent compound.

It is a solid at room temperature.

Which statement about sucrose is correct?

- A** It is made of atoms that are close together and in continuous random motion.
- B** It is made of atoms that are far apart and vibrating about a fixed point.
- C** It is made of molecules that are close together and vibrating about a fixed point.
- D** It is made of molecules that are far apart and in continuous random motion.

15 Which diagram shows how apparatus is used to separate the different colours in an ink?

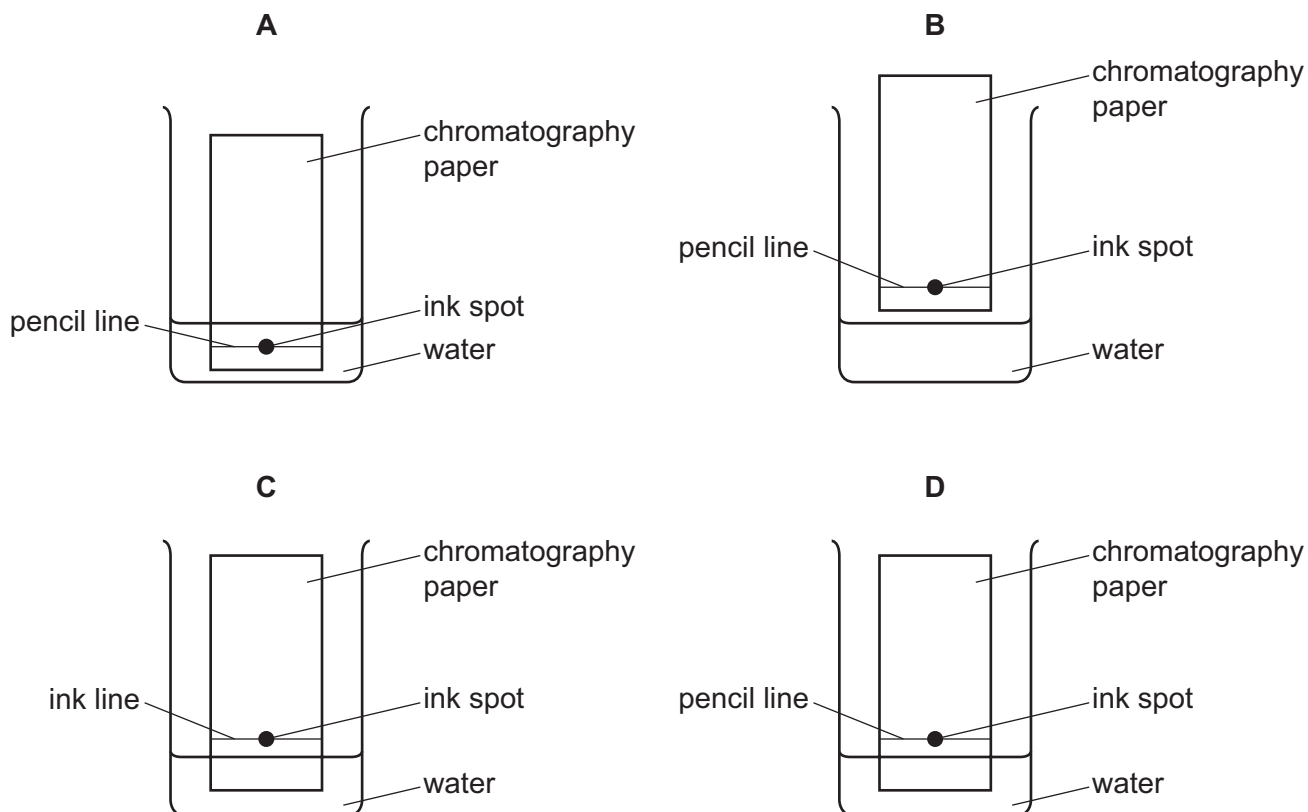

- 16 Which is the electronic structure of a noble gas?
- A 2,6                      B 2,8                      C 2,8,1                      D 2,8,7
- 17 What is the formula of nitric acid?
- A HCl                      B HNO<sub>3</sub>                      C NaOH                      D NH<sub>3</sub>
- 18 During the electrolysis of molten potassium chloride, which particles in the electrolyte move towards the cathode?
- A electrons  
B chloride ions  
C chlorine molecules  
D potassium ions
- 19 The temperature of some water is recorded.  
Sodium chloride is dissolved in the water and the temperature of the solution is recorded.
- temperature of water = 20 °C  
temperature of solution = 18 °C
- Which statement about the process is correct?
- A It is endothermic because chemical energy is changed into heat energy.  
B It is endothermic because heat energy is changed into chemical energy.  
C It is exothermic because chemical energy is changed into heat energy.  
D It is exothermic because heat energy is changed into chemical energy.
- 20 Substance X increases the rate of a chemical reaction, but it remains unchanged at the end of the reaction.
- Which word describes substance X?
- A catalyst  
B electrolyte  
C product  
D unreactive





25 What is observed when magnesium ribbon is placed into aqueous copper sulfate?

- A The blue solution gets darker and a brown solid appears.
- B The blue solution gets darker and no solid is visible.
- C The blue solution gets paler and a brown solid appears.
- D The blue solution gets paler and no solid is visible.

26 Gasoline is a hydrocarbon fuel obtained from petroleum.

Which statement is correct?

- A Gasoline burns to form carbon dioxide and water.
- B Gasoline contains the elements carbon, hydrogen and oxygen.
- C Gasoline is used as a fuel in diesel engines.
- D The combustion of gasoline is an endothermic reaction.

27 Which substance rapidly decolourises bromine?

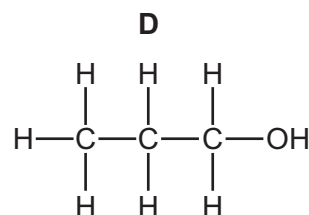
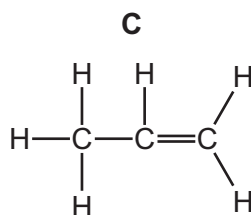
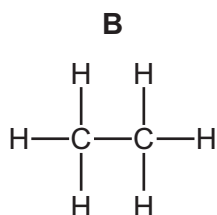
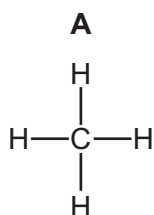

28 The graph shows the motion of a cyclist over a period of 30 s.

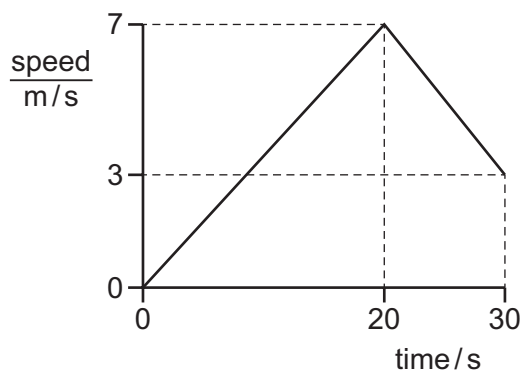

Which distance does she travel?

- A 90 m
- B 105 m
- C 115 m
- D 120 m

- 29 A cube of aluminium has sides of length 1.0 cm.

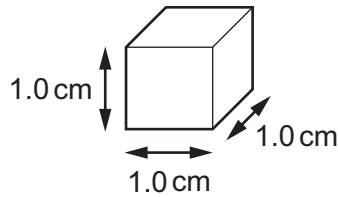

Compared with this cube, which statement about a cube of aluminium with sides of 2.0 cm is correct?

- A It has the same density.  
 B It has the same mass.  
 C It has twice the density.  
 D It has twice the mass.
- 30 A stretching force is applied to a copper wire. The wire obeys Hooke's Law until it reaches the limit of proportionality.

Which is the extension-load graph for the wire and shows the limit of proportionality labelled P?

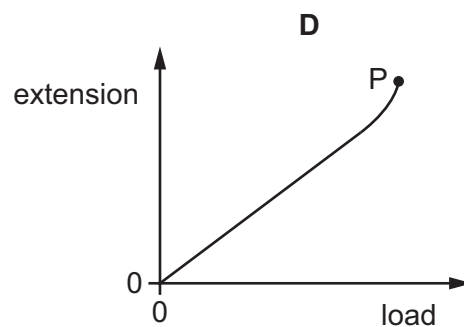
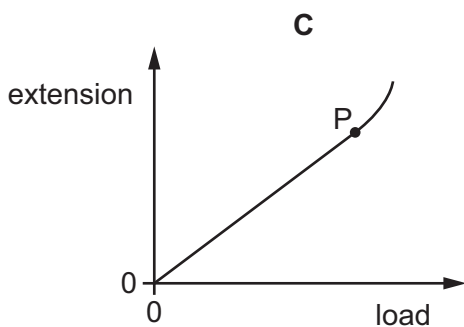
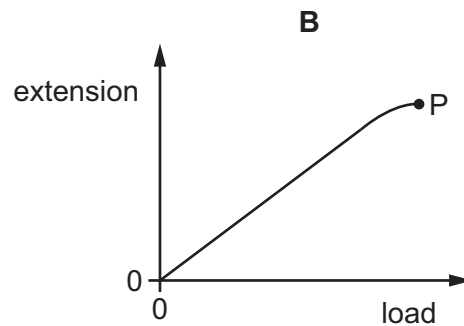
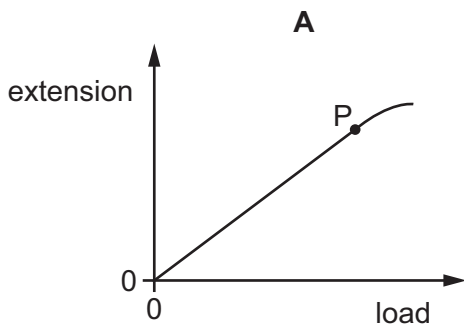

- 31** A brick of mass 4.0 kg rests on a window ledge. It falls off the window ledge and drops through a height of 5.0 m to the ground. The acceleration of free fall  $g$  is  $10 \text{ m/s}^2$ .

Air resistance can be ignored.

Which row states the kinetic energy and the speed of the brick just before it hits the ground?

	kinetic energy of brick/J	<u>speed of brick</u> m/s
<b>A</b>	20	2.2
<b>B</b>	20	3.2
<b>C</b>	200	7.1
<b>D</b>	200	10

- 32** A liquid evaporates when molecules leave its surface.

Which molecules leave the surface, and what happens to the temperature of the remaining liquid?

- A** The more energetic molecules leave and the temperature falls.
- B** The more energetic molecules leave and the temperature rises.
- C** The less energetic molecules leave and the temperature falls.
- D** The less energetic molecules leave and the temperature rises.
- 33** Convection is a process by which thermal energy is transferred from one place to another.

Where can convection take place?

- A** in a gas and in a vacuum
- B** in a liquid and in a gas
- C** in a liquid and in a solid
- D** in a solid and in a vacuum

- 34 A musical instrument produces a note of frequency 170 Hz. The sound wave produced travels through the air at a speed of 340 m/s.

Which row describes the sound wave?

	nature of wave	wavelength / m
<b>A</b>	longitudinal	0.50
<b>B</b>	longitudinal	2.0
<b>C</b>	transverse	0.50
<b>D</b>	transverse	2.0

- 35 A girl stands in front of a plane mirror and observes her image. She walks 2.0 m towards the mirror.

What is the change in the distance between the girl and her image?

- A** 0 m                      **B** 1.0 m                      **C** 2.0 m                      **D** 4.0 m

- 36 The diagrams represent four different sound waves. The scales are the same in all the diagrams.

Which sound has the lowest pitch?

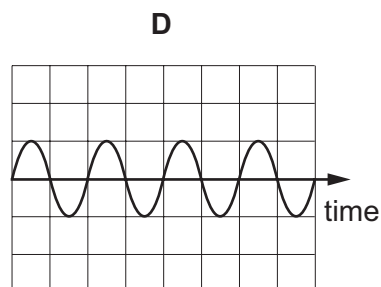
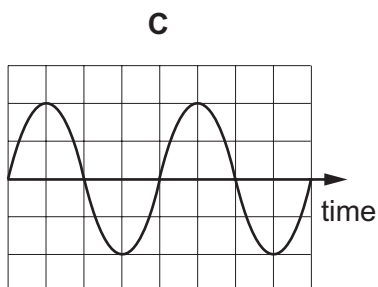
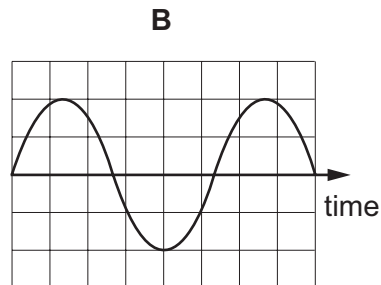
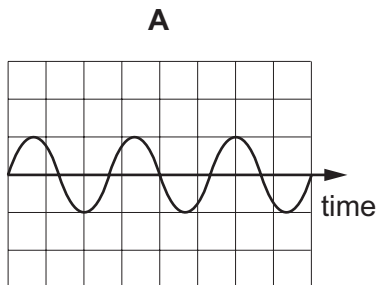

- 37 Three pieces of resistance wire X, Y and Z are made of the same metal.

The diagram shows the lengths and the diameters of the wires.

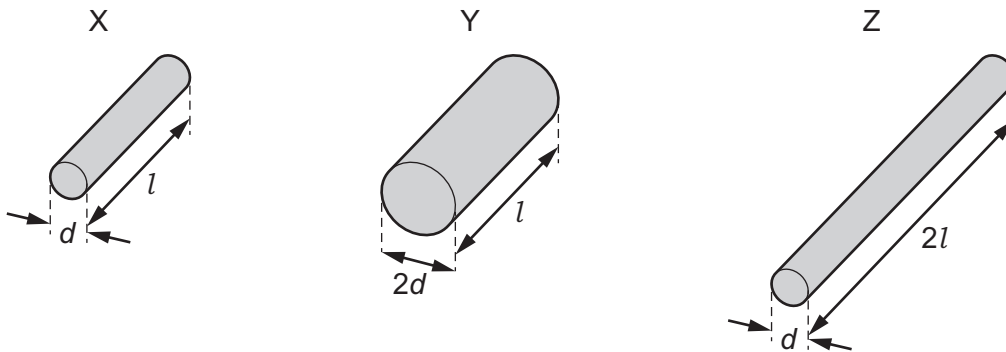

What is the order of the wires when they are placed in order of increasing resistance, least resistance first?

- A  $Y \rightarrow X \rightarrow Z$     B  $Y \rightarrow Z \rightarrow X$     C  $Z \rightarrow X \rightarrow Y$     D  $Z \rightarrow Y \rightarrow X$
- 38 A lamp has a potential difference  $V$  across it that causes a current  $I$  in it.

Which equation gives the power  $P$  produced by the lamp?

- A  $P = \frac{I}{V}$     B  $P = \frac{V}{I}$     C  $P = IV$     D  $P = I + V$

- 39 A kettle is connected to a power supply as shown.

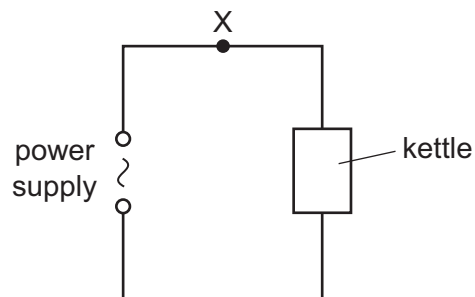

If too much current flows, a component connected at X automatically disconnects the power supply.

Which symbol represents the component at X?

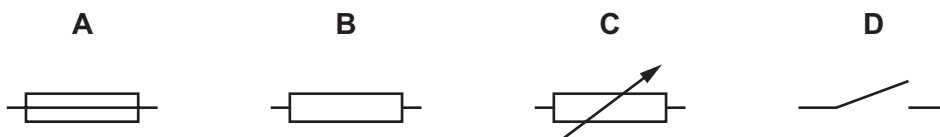

- 40 A student sets up the circuit shown in the diagram. The ammeter reads 0.60 A and the voltmeter reads 3.0 V.

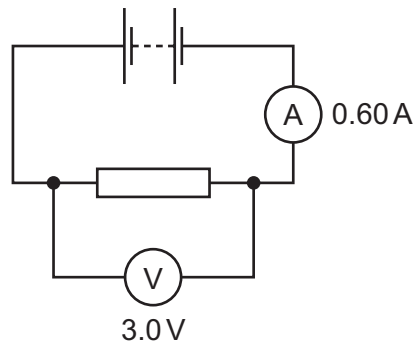

The student now takes two resistors that are identical to the original resistor. She connects them in series with the original resistor.

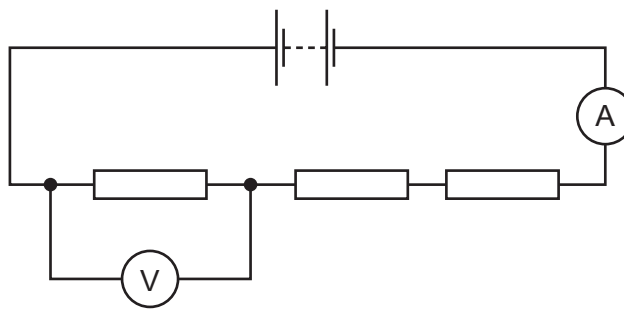

What are the new readings on the ammeter and the voltmeter?

	ammeter / A	voltmeter / V
<b>A</b>	0.20	1.0
<b>B</b>	0.20	3.0
<b>C</b>	0.60	1.0
<b>D</b>	0.60	3.0

Permission to reproduce items where third-party owned material protected by copyright is included has been sought and cleared where possible. Every reasonable effort has been made by the publisher (UCLES) to trace copyright holders, but if any items requiring clearance have unwittingly been included, the publisher will be pleased to make amends at the earliest possible opportunity.

To avoid the issue of disclosure of answer-related information to candidates, all copyright acknowledgements are reproduced online in the Cambridge International Examinations Copyright Acknowledgements Booklet. This is produced for each series of examinations and is freely available to download at [www.cie.org.uk](http://www.cie.org.uk) after the live examination series.

Cambridge International Examinations is part of the Cambridge Assessment Group. Cambridge Assessment is the brand name of University of Cambridge Local Examinations Syndicate (UCLES), which is itself a department of the University of Cambridge.

