



Cambridge International Examinations
Cambridge International General Certificate of Secondary Education

COMBINED SCIENCE

0653/22

Paper 2 Multiple Choice (Extended)

October/November 2017

45 minutes

Additional Materials: Multiple Choice Answer Sheet
Soft clean eraser
Soft pencil (type B or HB is recommended)



READ THESE INSTRUCTIONS FIRST

Write in soft pencil.

Do not use staples, paper clips, glue or correction fluid.

Write your name, Centre number and candidate number on the Answer Sheet in the spaces provided unless this has been done for you.

DO NOT WRITE IN ANY BARCODES.

There are **forty** questions on this paper. Answer **all** questions. For each question there are four possible answers **A, B, C** and **D**.

Choose the **one** you consider correct and record your choice in **soft pencil** on the separate Answer Sheet.

Read the instructions on the Answer Sheet very carefully.

Each correct answer will score one mark. A mark will not be deducted for a wrong answer.

Any rough working should be done in this booklet.

A copy of the Periodic Table is printed on page 20.

Electronic calculators may be used.

This document consists of **17** printed pages and **3** blank pages.

1 Which characteristics help to define a living organism?

- A diffusion, movement, respiration
- B excretion, nutrition, sensitivity
- C excretion, reproduction, transpiration
- D growth, inspiration, nutrition

2 The diagram shows a palisade cell.

Which structure converts energy from light into chemical energy?

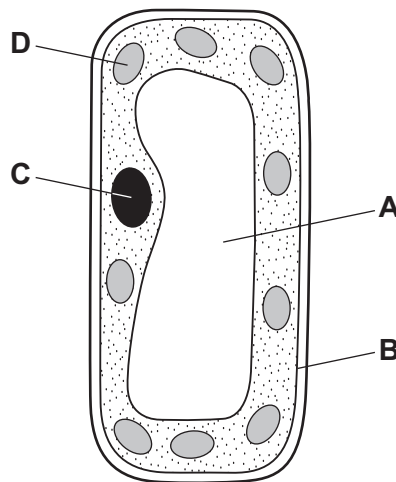

3 What is the role of microorganisms in the manufacture of yoghurt?

- A to turn lactic acid into lactose sugar and lower the pH
- B to turn lactic acid into lactose sugar and raise the pH
- C to turn lactose sugar into lactic acid and lower the pH
- D to turn lactose sugar into lactic acid and raise the pH

4 In which order does food pass through parts of the alimentary canal?

- A oesophagus → colon → small intestine
- B small intestine → oesophagus → rectum
- C small intestine → rectum → anus
- D stomach → colon → small intestine

5 These four conditions may be a result of malnutrition.

- 1 constipation
- 2 coronary heart disease
- 3 obesity
- 4 starvation

Which conditions are a direct result of an imbalance between energy intake and energy output?

- A** 1 and 2 **B** 1 and 4 **C** 2 and 3 **D** 3 and 4

6 What are the functions of root hairs?

	uptake of ions	uptake of sugar	uptake of water
A	✓	x	x
B	✓	x	✓
C	x	✓	x
D	x	✓	✓

7 When we cut ourselves, blood comes out of the wound.

Which constituent of blood is most important in the formation of a blood clot?

- A** plasma
B platelets
C red blood cells
D white blood cells

8 What is the equation for aerobic respiration?

- A** $6\text{CO}_2 + 6\text{O}_2 \rightarrow \text{C}_6\text{H}_{12}\text{O}_6 + 6\text{H}_2\text{O}$
B $6\text{H}_2\text{O} + 6\text{CO}_2 \rightarrow \text{C}_6\text{H}_{12}\text{O}_6 + 6\text{O}_2$
C $\text{C}_6\text{H}_{12}\text{O}_6 + 6\text{H}_2\text{O} \rightarrow 6\text{CO}_2 + 6\text{O}_2$
D $\text{C}_6\text{H}_{12}\text{O}_6 + 6\text{O}_2 \rightarrow 6\text{CO}_2 + 6\text{H}_2\text{O}$

- 9 The depth and rate of breathing can be measured by a spirometer, and recorded in the form of a graph.

Graph X shows the depth and rate of breathing of a person at rest.

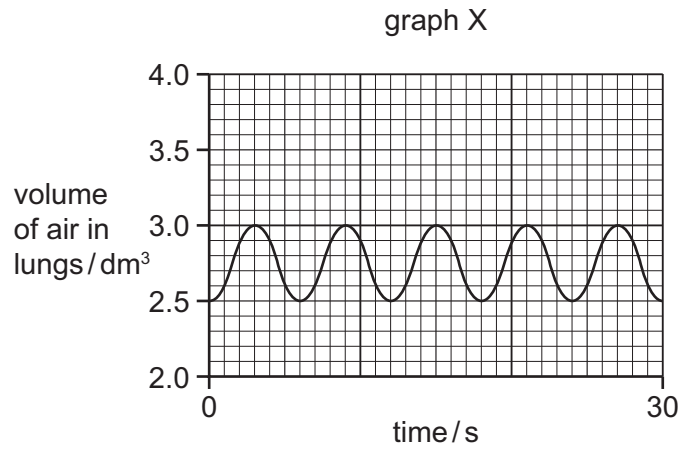

Which graph shows the depth and rate of breathing when the same person is running?

A

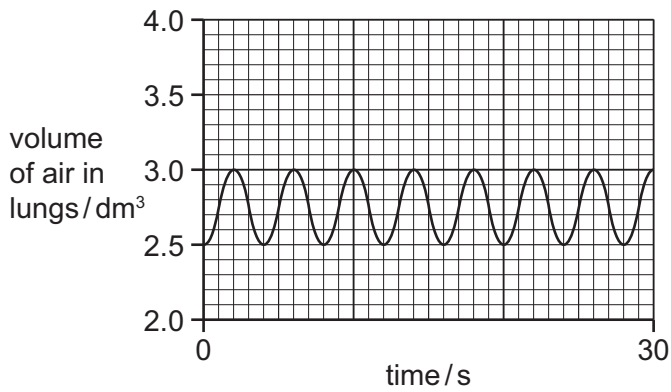

B

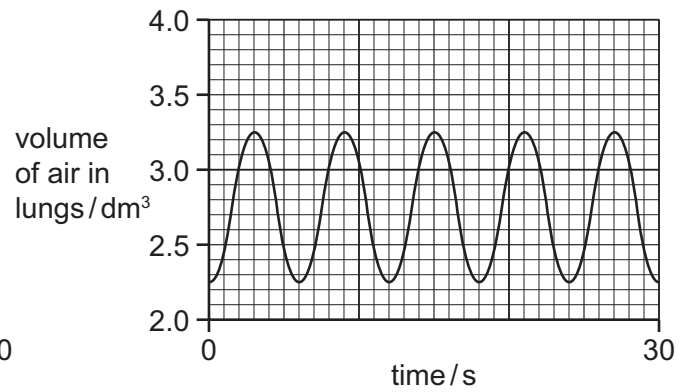

C

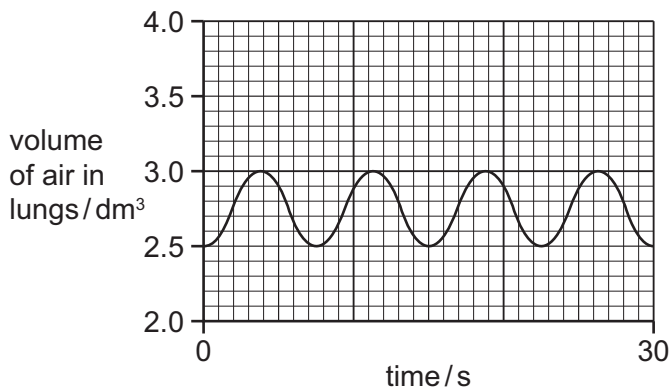

D

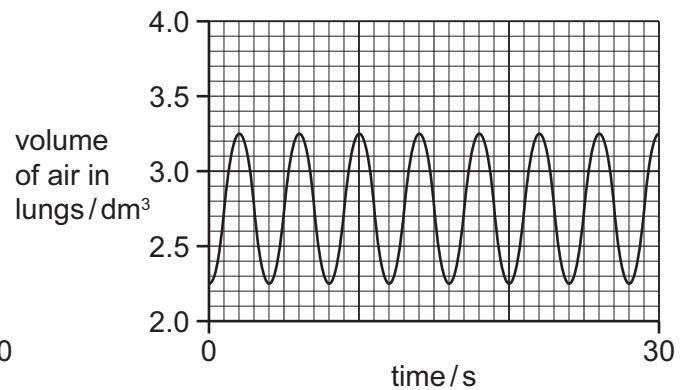

10 A student carried out an experiment to test geotropism.

A bean seed was pinned to a card with wet cotton wool, as shown.

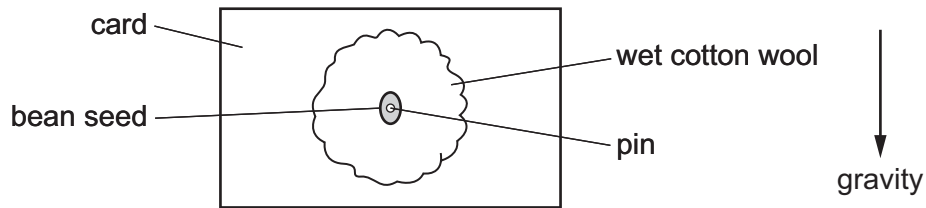

Every day the card was turned 90° clockwise.

After a few days the student drew the results of the root growth.

Which diagram shows the student's result?

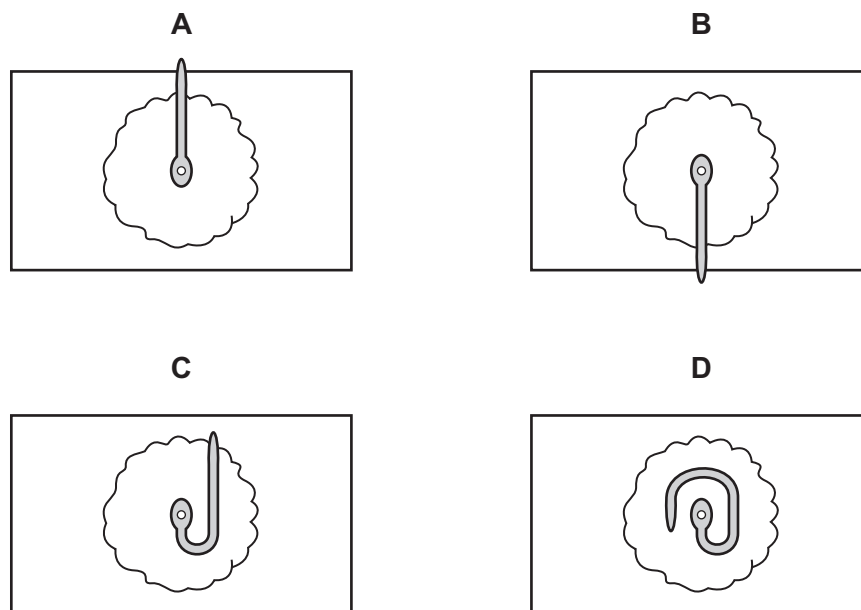

11 During pregnancy, the fetus is contained within the amniotic sac. The amniotic sac contains amniotic fluid.

What is the function of the amniotic fluid?

- A It protects the fetus against knocks and bumps.
- B It provides the fetus with oxygen and nutrients.
- C It removes the fetal waste products.
- D It supplies the fetus with blood.

12 The diagram shows a food web.

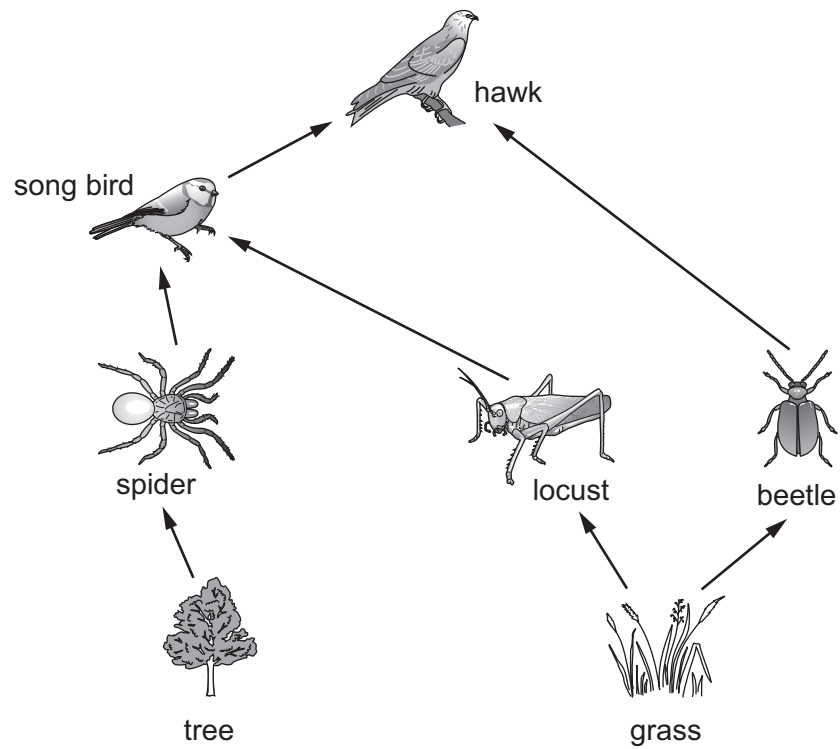

Which statement about this food web is correct?

- A** Some of the energy from the grass eventually passes to the hawk.
- B** The producers get their energy from the soil.
- C** There are more carnivores shown than herbivores.
- D** There are six consumers shown.

- 13 Which graph shows the effect of large-scale deforestation on the changes in the concentrations of oxygen and carbon dioxide in the air?

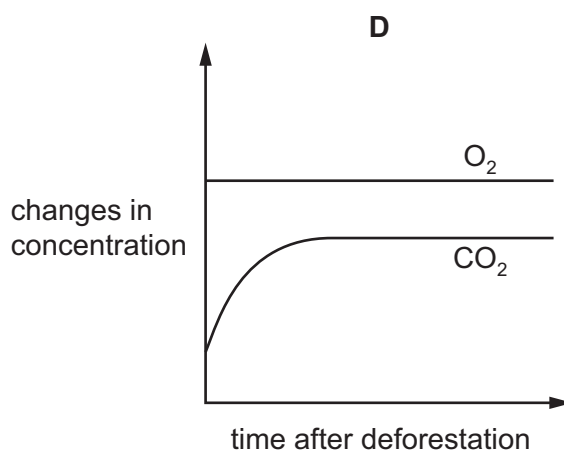
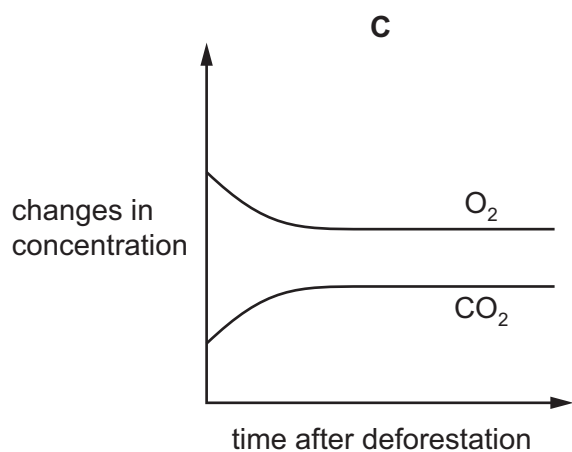
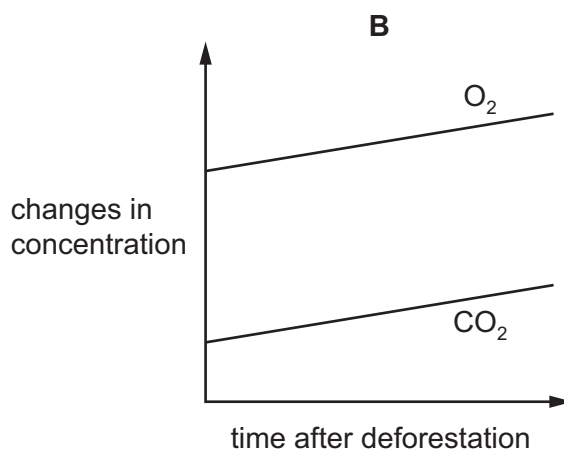
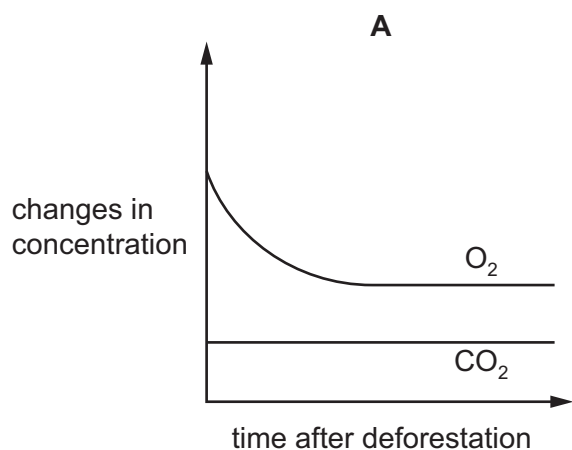

- 14 The formulae of three substances are shown.

substance	formula
methane	CH_4
water	H_2O
oxygen	O_2

Which statement is correct?

- A** Methane is made from five different types of atom.
- B** Methane, water and oxygen are molecules.
- C** Only methane and water are molecules.
- D** Oxygen is made from two different types of atom.

- 15 What is the correct sequence that takes place during fractional distillation?
- A evaporate → condense → collect → heat
 B evaporate → condense → heat → collect
 C heat → condense → collect → evaporate
 D heat → evaporate → condense → collect
- 16 Which substances react to produce a mixture of an element and a compound?
- A copper oxide and carbon
 B hydrochloric acid and sodium carbonate
 C hydrogen and oxygen
 D nitric acid and sodium hydroxide

- 17 The electronic structure of a sodium atom is 2,8,1.

The electronic structure of a sodium ion is 2,8.

Which statement is **not** correct?

- A Sodium ions form metallic bonds.
 B The electronic structure of a sodium ion is more stable than that of a sodium atom.
 C The sodium atom loses one electron to become an ion.
 D The sodium ion has a noble gas electronic structure.
- 18 The symbols for some ions are shown.

name of ion	symbol
silver	Ag^+
nitrate	NO_3^-
magnesium	Mg^{2+}
chloride	Cl^-

Which symbol equation is correct?

- A $\text{AgNO}_3 + \text{MgCl} \rightarrow \text{AgCl} + \text{MgNO}_3$
 B $\text{Ag}_2\text{NO}_3 + \text{MgCl} \rightarrow \text{Ag}_2\text{Cl} + \text{MgNO}_3$
 C $2\text{AgNO}_3 + \text{MgCl}_2 \rightarrow 2\text{AgCl} + \text{Mg}(\text{NO}_3)_2$
 D $2\text{AgNO}_3 + \text{Mg}_2\text{Cl} \rightarrow 2\text{AgCl} + 2\text{MgNO}_3$

19 What is formed at the cathode during the electrolysis of aqueous copper chloride?

- A chlorine
- B copper
- C hydrogen
- D oxygen

20 The diagram shows gas X burning and heating a liquid.

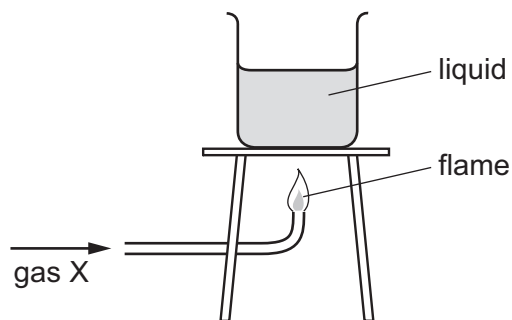

Which row is correct?

	gas X	the burning of gas X is exothermic
A	hydrogen	✓
B	hydrogen	x
C	oxygen	✓
D	oxygen	x

21 What is the effect of increasing the temperature on the collisions between reacting particles during a chemical reaction?

	number of collisions per second	energy of collisions
A	decreases	decreases
B	decreases	increases
C	increases	decreases
D	increases	increases

- 22 The word equation for the reaction between hydrogen and copper oxide is shown.

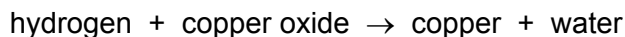

Which substance, shown in the word equation, is reduced in the reaction?

- A copper
 - B copper oxide
 - C hydrogen
 - D water
- 23 Excess aqueous barium nitrate is added to dilute sulfuric acid to produce barium sulfate.
- How is barium sulfate obtained from the reaction mixture?
- A electrolysis
 - B evaporation
 - C filtration
 - D fractional distillation
- 24 Weather balloons are used to carry scientific instruments into the atmosphere.
- Which gas is used to fill the balloons?
- A argon
 - B helium
 - C krypton
 - D xenon
- 25 Which reaction does **not** take place in the blast furnace?
- A Calcium carbonate decomposes to make calcium oxide.
 - B Carbon dioxide reacts with carbon to make carbon monoxide.
 - C Carbon monoxide reacts with iron oxide to make iron.
 - D Limestone reacts with iron oxide to make slag.

26 P, Q, R and S are four gases found in clean air.

P is very unreactive.

Q makes up 21% of the air.

R makes up 78% of the air.

S is formed when fossil fuels are burned.

Which row is correct?

	P	Q	R	S
A	argon	nitrogen	oxygen	carbon dioxide
B	argon	oxygen	nitrogen	carbon dioxide
C	carbon dioxide	oxygen	nitrogen	argon
D	carbon dioxide	nitrogen	oxygen	argon

27 In the fractional distillation of petroleum, fractions X and Y are removed at the positions shown.

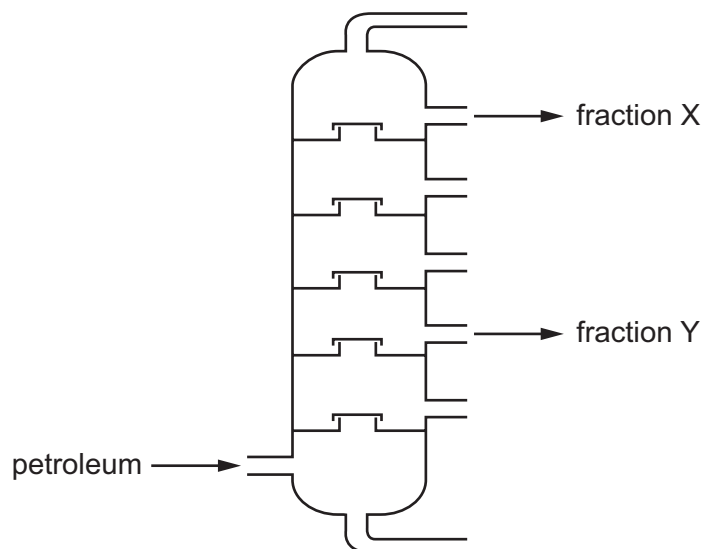

Which row describes the molecular sizes and the intermolecular attractive forces in fractions X and Y?

	molecular sizes	intermolecular attractive forces
A	X larger than Y	X greater than Y
B	X larger than Y	Y greater than X
C	Y larger than X	X greater than Y
D	Y larger than X	Y greater than X

28 The speed-time graph shown is for a bus travelling between stops.

Where on the graph is the acceleration of the bus greatest?

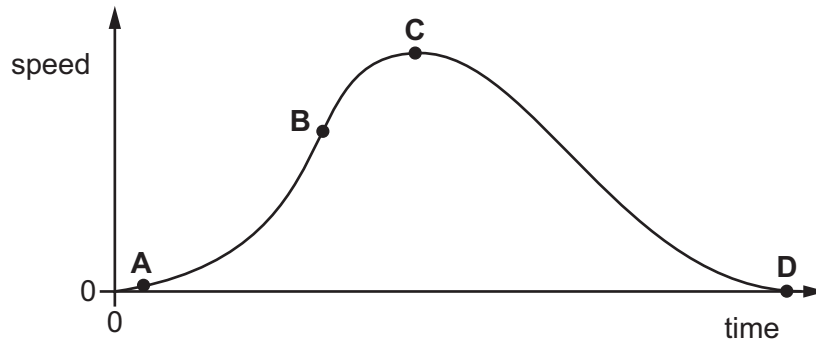

29 The table gives the volumes and masses of four objects.

Which object has the greatest density?

	mass/g	volume/cm ³
A	5.4	2.0
B	13	3.0
C	15	6.0
D	18	5.0

30 A student stretches a steel spring by hanging a load on it. The measurements for the extension of the spring are shown in the table.

load/N	1.0	2.0	3.0	4.0	5.0	6.0
extension/cm	0.5	1.0	1.5	2.0	2.5	3.0

What is the value for the spring constant k of the spring?

A 0.50 N/cm **B** 1.0 N/cm **C** 2.0 N/cm **D** 18 N/cm

31 A 600 W motor is 75% efficient. The motor is used to do 3600 J of useful work.

How long does it take the motor to do this work?

A 4.5 s **B** 6.0 s **C** 8.0 s **D** 24 s

32 Which description is correct for the molecules of a gas with a temperature that is rising?

	force between molecules	average speed of molecules
A	negligible	decreasing
B	negligible	increasing
C	strong	decreasing
D	strong	increasing

33 The diagram shows a heater above a thermometer. The thermometer bulb is in the position shown.

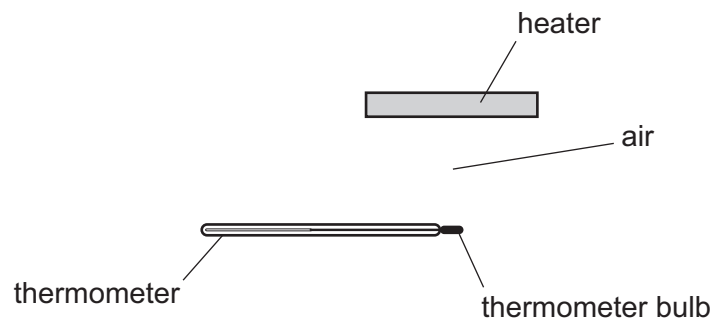

Which row shows how the heat energy from the heater reaches the thermometer bulb?

	conduction	convection	radiation
A	no	no	yes
B	no	yes	no
C	no	yes	yes
D	yes	yes	no

34 The diagram shows a section of a rope.

Four wave crests pass a point on the rope every second.

Each wave crest travels 80 cm in one second.

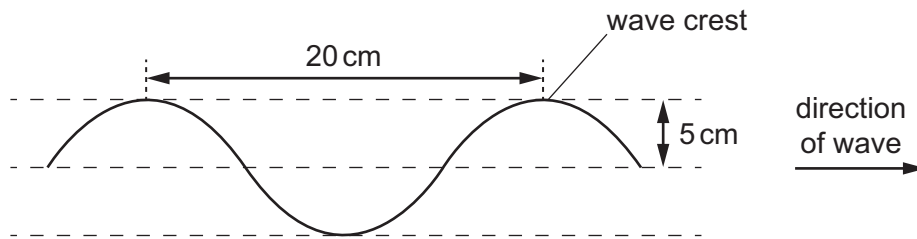

What is the speed of the wave?

- A 4.0 cm/s B 5.0 cm/s C 20 cm/s D 80 cm/s

35 Two plane mirrors are placed at 90° to each other. A ray of light strikes one mirror at an angle of incidence of 60° .

Which diagram shows this ray and its path after reflection?

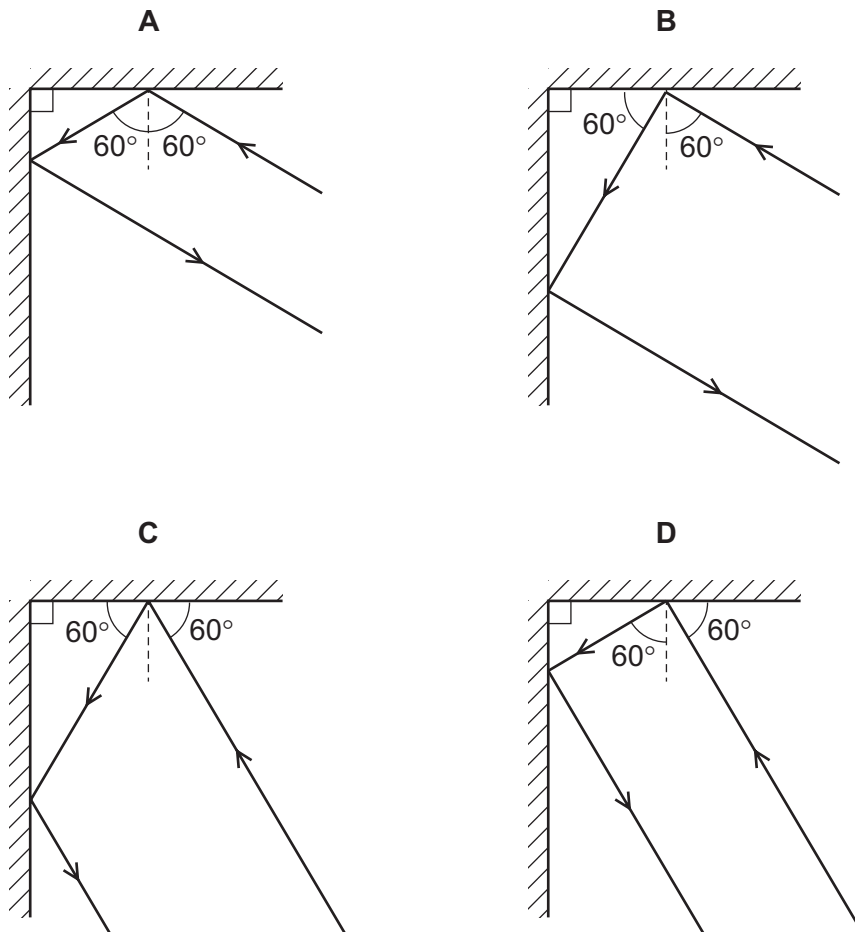

36 Electromagnetic waves are used to scan passengers' luggage before they board an aeroplane.

Electromagnetic waves are also used in a television remote controller.

Which type of electromagnetic wave is used for each of these purposes?

	scanning luggage	television remote controller
A	radio waves	infra-red waves
B	radio waves	ultraviolet waves
C	X-rays	infra-red waves
D	X-rays	ultraviolet waves

37 The diagram represents a wave in air. Molecules are closer together in region P than they are in region Q.

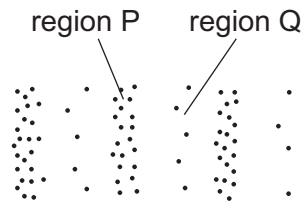

What are the names of regions P and Q, and which type of wave is represented?

	region P	region Q	type of wave
A	compression	rarefaction	longitudinal
B	compression	rarefaction	transverse
C	rarefaction	compression	longitudinal
D	rarefaction	compression	transverse

38 A piece of wire has electrical resistance.

The wire is stretched so that it becomes longer and thinner.

What, if anything, happens to its resistance?

- A** It could increase or decrease depending on how much it is stretched.
- B** It does not change because its smaller diameter cancels the effect of its greater length.
- C** It must decrease.
- D** It must increase.

- 39 The device Z in this circuit is designed to cut off the electricity supply **automatically** if too much current flows.

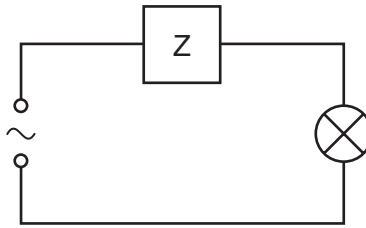

What is device Z?

- A a fuse
 - B a resistor
 - C a switch
 - D an ammeter
- 40 The diagram shows three resistors connected to a 12 V battery.

The current at two points in the circuit and the p.d. across one resistor are shown.

Another resistor is labelled R.

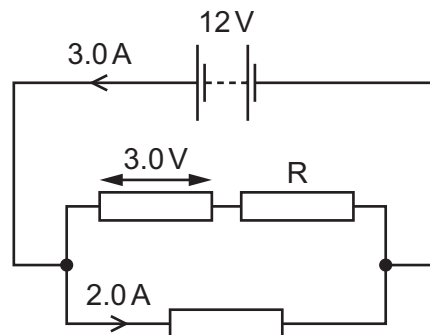

What is the current in resistor R and what is the p.d. across resistor R?

	current in resistor R / A	p.d. across resistor R / V
A	1.0	3.0
B	1.0	9.0
C	2.0	3.0
D	2.0	9.0

BLANK PAGE

BLANK PAGE

BLANK PAGE

Permission to reproduce items where third-party owned material protected by copyright is included has been sought and cleared where possible. Every reasonable effort has been made by the publisher (UCLES) to trace copyright holders, but if any items requiring clearance have unwittingly been included, the publisher will be pleased to make amends at the earliest possible opportunity.

To avoid the issue of disclosure of answer-related information to candidates, all copyright acknowledgements are reproduced online in the Cambridge International Examinations Copyright Acknowledgements Booklet. This is produced for each series of examinations and is freely available to download at www.cie.org.uk after the live examination series.

Cambridge International Examinations is part of the Cambridge Assessment Group. Cambridge Assessment is the brand name of University of Cambridge Local Examinations Syndicate (UCLES), which is itself a department of the University of Cambridge.

