



Cambridge International Examinations
Cambridge International General Certificate of Secondary Education

COMBINED SCIENCE

0653/13

Paper 1 Multiple Choice

October/November 2015

45 minutes

Additional Materials: Multiple Choice Answer Sheet
Soft clean eraser
Soft pencil (type B or HB is recommended)



READ THESE INSTRUCTIONS FIRST

Write in soft pencil.

Do not use staples, paper clips, glue or correction fluid.

Write your name, Centre number and candidate number on the Answer Sheet in the spaces provided unless this has been done for you.

DO NOT WRITE IN ANY BARCODES.

There are **forty** questions on this paper. Answer **all** questions. For each question there are four possible answers **A, B, C** and **D**.

Choose the **one** you consider correct and record your choice in **soft pencil** on the separate Answer Sheet.

Read the instructions on the Answer Sheet very carefully.

Each correct answer will score one mark. A mark will not be deducted for a wrong answer.

Any rough working should be done in this booklet.

A copy of the Periodic Table is printed on page 20.

Electronic calculators may be used.

This document consists of **18** printed pages and **2** blank pages.

1 What are three characteristics of living organisms?

	characteristic 1	characteristic 2	characteristic 3
A	breathing	reproduction	sensitivity
B	digestion	growth	movement
C	excretion	nutrition	transpiration
D	nutrition	reproduction	sensitivity

2 The diagram shows a liver cell, as seen using a light microscope.

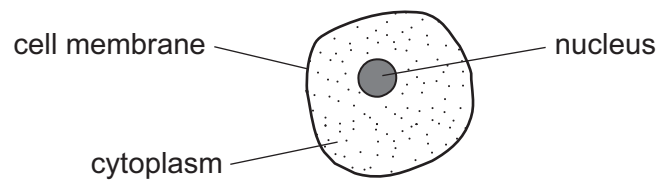

Which of the labelled structures would also be present in a palisade cell?

- A** all of them
- B** cell membrane only
- C** cell membrane and cytoplasm only
- D** cytoplasm and nucleus only

- 3 A student carries out an experiment to investigate diffusion. Two dyes are injected into the middle of a sealed tube of water. The diagram shows the particles of dye in the tube just after the dyes are injected.

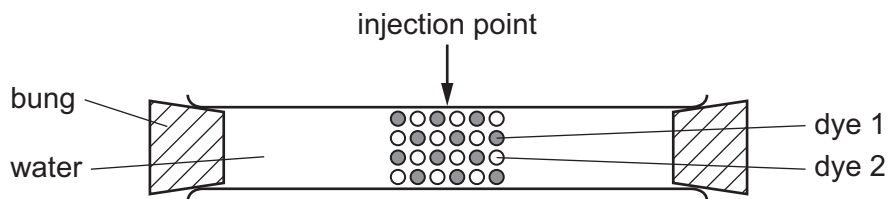

The tube is left for an hour.

Which diagram shows the distribution of the particles of dye after this time?

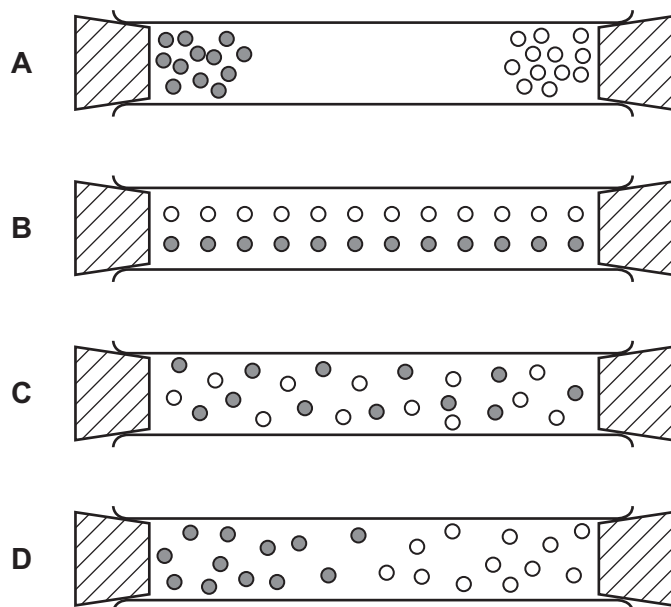

- 4 The graph shows the effect of temperature on the rate of an enzyme-controlled reaction.

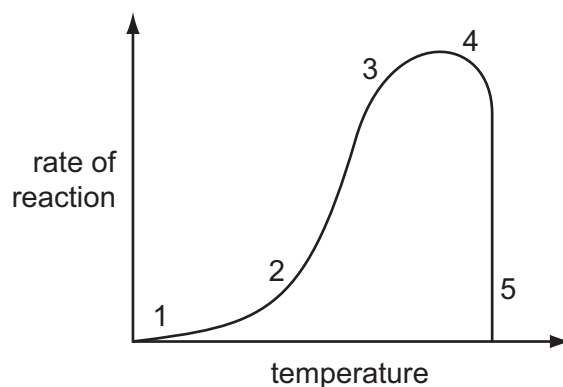

Where on the graph has all the enzyme been denatured?

- A 1 B 2 and 3 C 3 and 4 D 5

5 The diagram shows a section through a leaf.

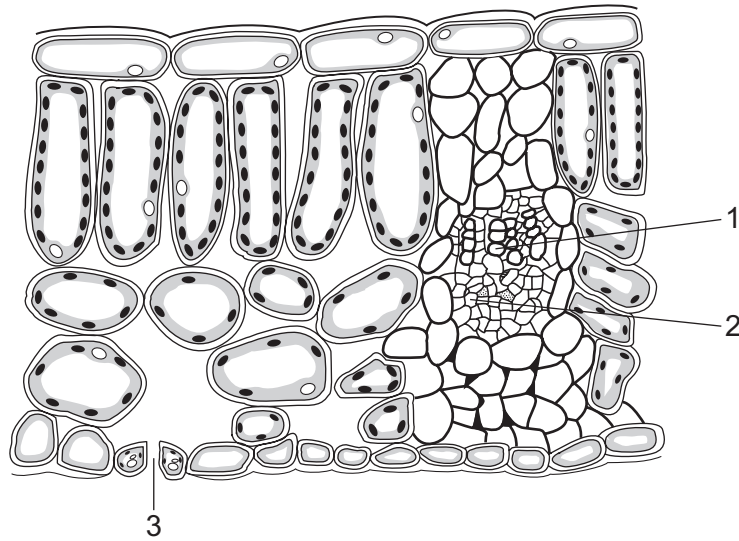

Where does carbon dioxide enter the leaf and where does water leave?

	carbon dioxide enters	water leaves
A	1	2
B	1	3
C	3	1
D	3	3

6 The drawing shows some blood, as it appears under the microscope.

Which part carries glucose to muscles?

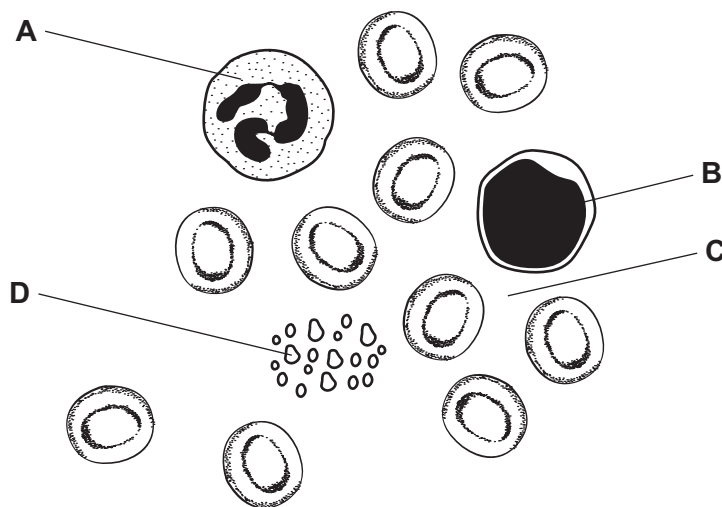

7 The diagram shows some structures in the human thorax (chest).

Into which part does carbon dioxide pass immediately after leaving the blood?

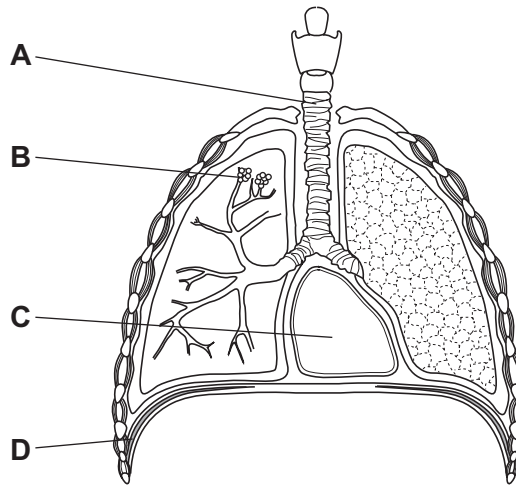

8 Carbon dioxide turns limewater milky (cloudy).

Which diagram shows apparatus being used to demonstrate that expired air contains more carbon dioxide than inspired air?

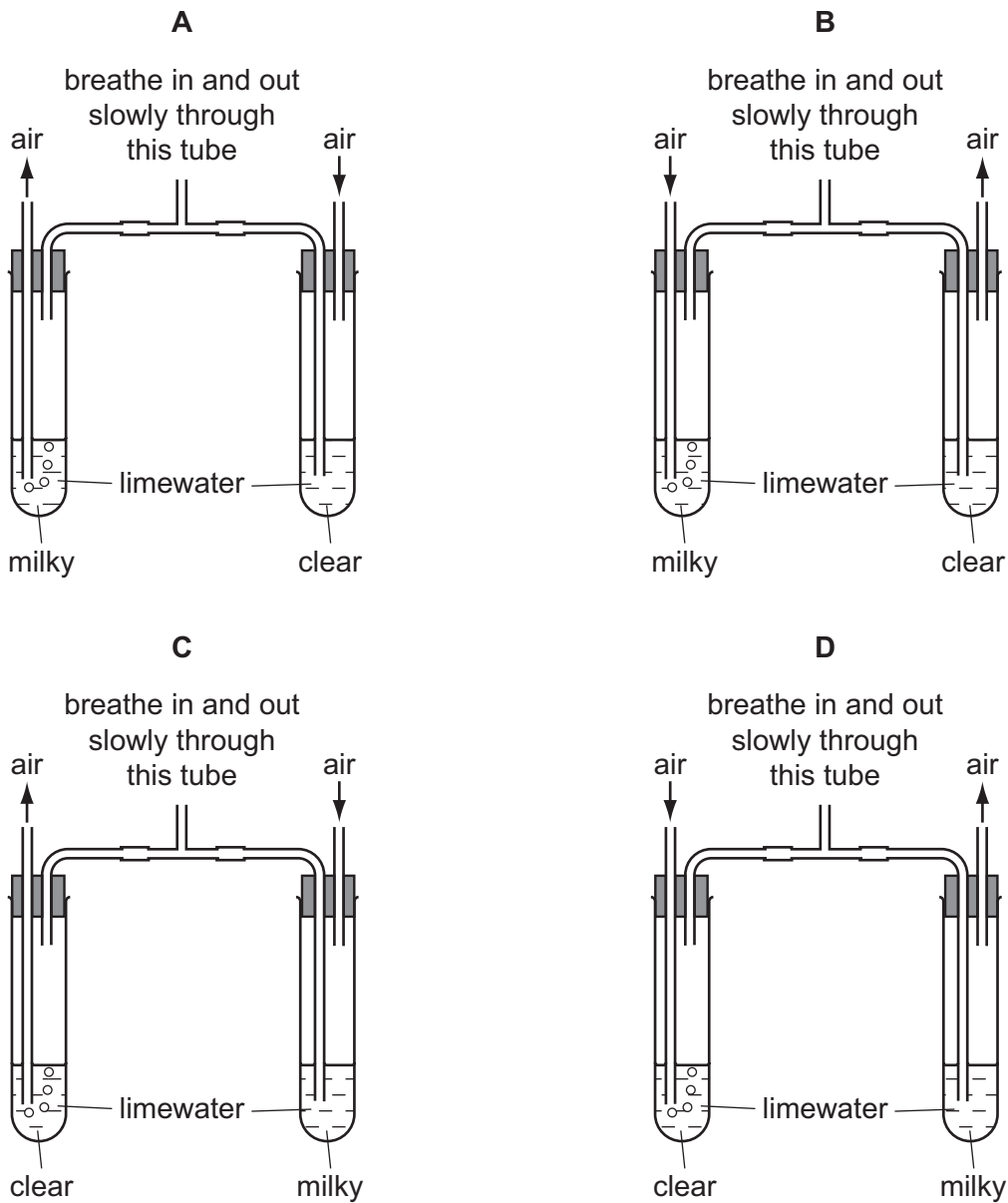

9 Which are effects of the hormone adrenaline?

	increase in blood glucose concentration	decrease in pulse rate
A	✓	✓
B	✓	x
C	x	✓
D	x	x

10 The diagram shows the root of a plant exposed to light and gravity, and the same root a day later.

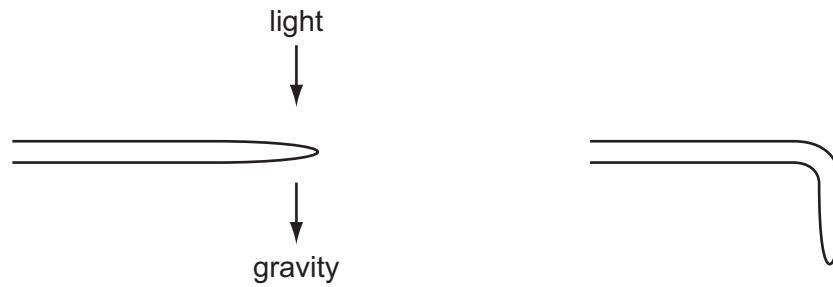

Light does **not** influence the growth of roots in this plant.

Which row shows how the root has responded?

	geotropism	phototropism
A	grows away from the stimulus	no response
B	grows towards the stimulus	no response
C	no response	grows away from the stimulus
D	no response	grows towards the stimulus

11 Which structure in a flower produces pollen?

- A sepal
- B stamen
- C stigma
- D style

12 The diagram shows the female reproductive system.

Which labelled structure is the cervix?

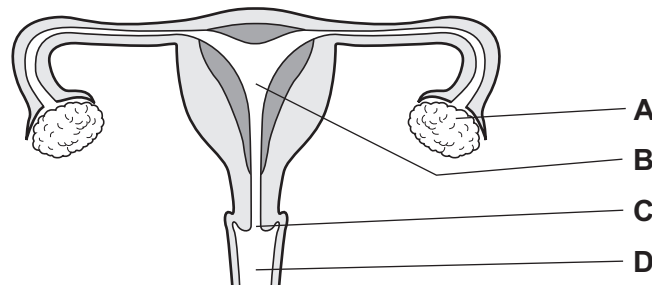

13 The diagram shows a food web.

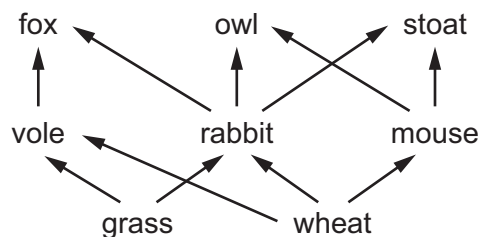

Which food chain is part of this food web?

- A grass → mouse → owl
- B grass → vole → stoat
- C wheat → mouse → owl
- D wheat → vole → stoat

14 The diagram represents a mixture of carbon dioxide, CO₂, and carbon monoxide, CO.

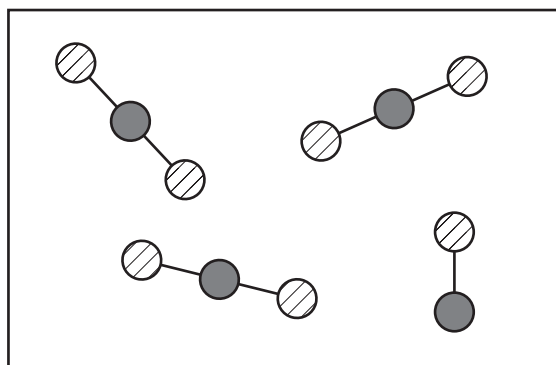

Which statement is correct?

- A The mixture contains 4 elements.
- B The mixture contains 4 molecules.
- C The mixture contains 11 elements.
- D The mixture contains 11 molecules.

- 15 In an experiment, a mixture of 0.5g of copper and 3g of zinc is added to an excess of dilute sulfuric acid.

The copper acts as a catalyst.

After all the zinc has dissolved, the resulting mixture is filtered.

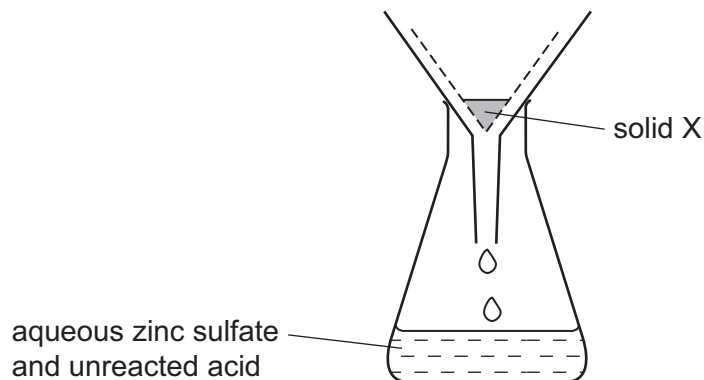

What is solid X and what is its mass?

	solid X	mass of pure X
A	copper	less than 0.5g
B	copper	0.5g
C	copper(II) oxide	0.5g
D	copper(II) oxide	greater than 0.5g

- 16 Element Y has a proton number of 18 and a nucleon number of 40.

Which statements about element Y are correct?

- 1 It has 40 neutrons in its nucleus.
- 2 It has 22 electrons.
- 3 It is unreactive.
- 4 It is in Group 0 of the Periodic Table.

- A** 1 and 2 **B** 2 and 3 **C** 2 and 4 **D** 3 and 4

- 17 The structure of a compound is shown.

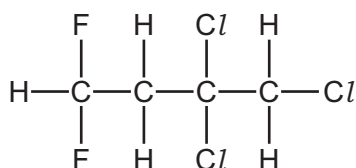

What is the formula of the compound?

- A** CHClF **B** C₄H₅Cl₂F₂ **C** C₄H₅Cl₃F₂ **D** C₄H₅Cl₃F

18 The apparatus shown is set up.

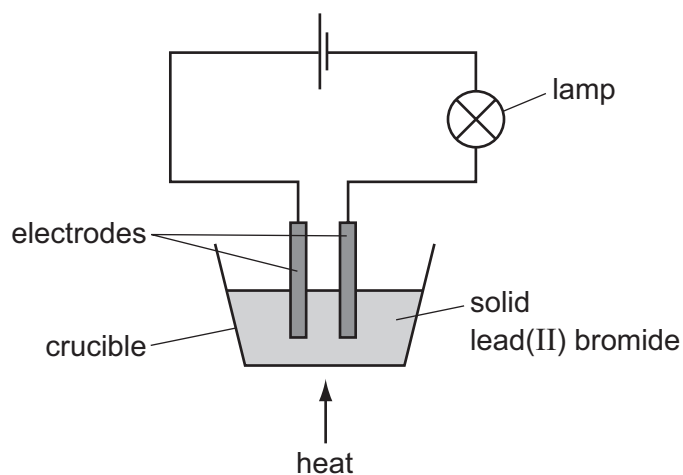

The crucible needs to be heated for the lamp to give out light.

Why is heat needed?

- A An exothermic reaction takes place in the crucible.
- B Electrodes only conduct electricity when hot.
- C Heat causes the lead(II) bromide to react with air.
- D The lead(II) bromide must be molten.

19 Hydrochloric acid is slowly added to sodium hydroxide in an insulated beaker.

The reaction is exothermic.

Which graph shows how the temperature changes during the reaction?

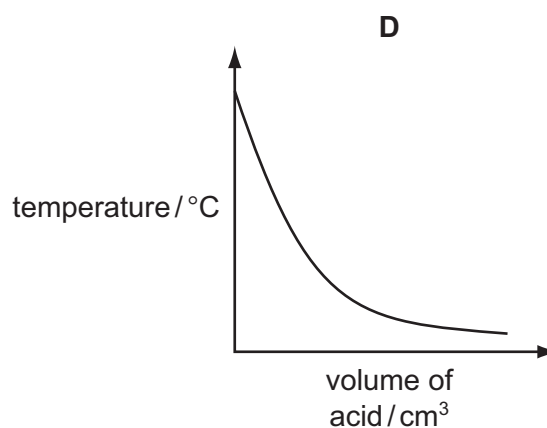
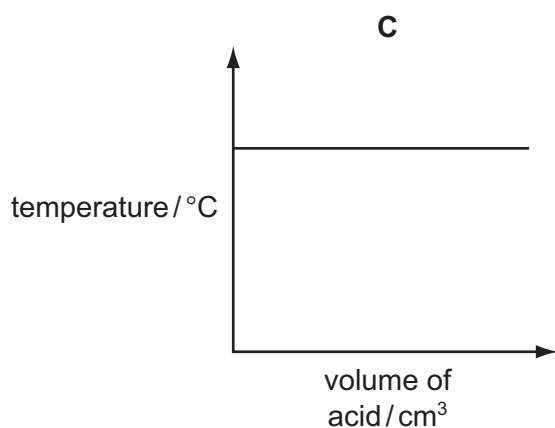
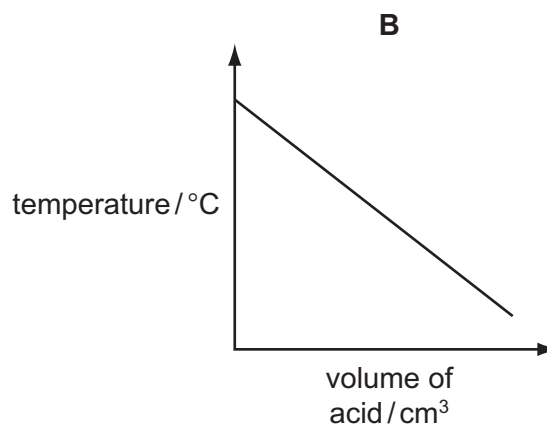
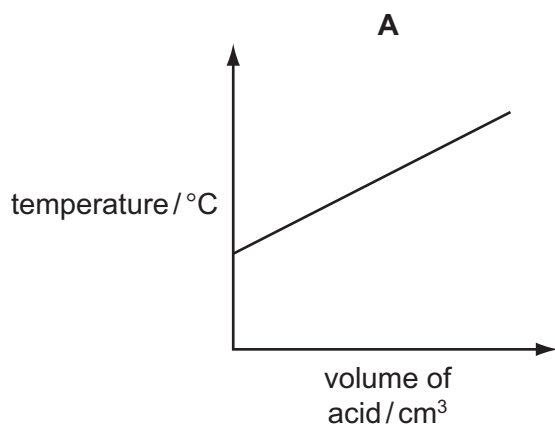

20 When a solid lump of calcium carbonate is added to excess hydrochloric acid, it reacts and bubbles can be seen.

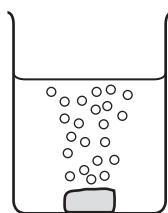

Which change does **not** increase the rate of reaction?

- A** Increase the concentration of the acid.
- B** Increase the surface area of the solid.
- C** Increase the temperature.
- D** Increase the volume of the acid.

21 Copper sulfate crystals are prepared by reacting copper oxide with sulfuric acid.

Which process is **not** used in the preparation of copper sulfate crystals?

- A chromatography
- B crystallisation
- C evaporation
- D filtration

22 A substance reacts with dilute acid, producing a gas.

The gas ignites with a pop when tested with a lighted splint.

What is the substance?

- A copper
- B copper(II) oxide
- C magnesium
- D magnesium carbonate

23 The positions of four elements are shown in the outline of the Periodic Table.

Which element has a high melting point and forms coloured compounds?

								A										B
C	D																	

24 Element X has a high density and is used as a catalyst.

What is X?

- A carbon
- B sodium
- C sulfur
- D vanadium

25 A metal is added to water. It floats and reacts vigorously.

What is the pH of the resulting solution?

- A 1 B 5 C 7 D 14

26 What is a chemical test for water?

- A Blue cobalt chloride paper turns pink.
B Measure its boiling point which is 100 °C.
C Measure its melting point which is 0 °C.
D Pink cobalt chloride paper turns blue.

27 Gas oil is a fraction formed when petroleum is fractionally distilled.

What is a use of gas oil?

- A bottled gas
B cooking
C diesel engine fuel
D heating

28 A tunnel is 50 km long. A train takes 20 min to travel between the two ends of the tunnel.

What is the average speed of the train in the tunnel?

- A 2.5 km/hour
B 16.6 km/hour
C 150 km/hour
D 1000 km/hour

29 Which of the following has the same unit as weight?

- A density
B energy
C force
D mass

30 Which items of apparatus are used to determine the density of a liquid?

- A balance and measuring cylinder
- B balance and thermometer
- C metre rule and measuring cylinder
- D metre rule and thermometer

31 What is the unit for work and what is the unit for power?

	work	power
A	J	N
B	J	W
C	N	W
D	W	J

32 The diagram shows a cyclist riding along a hilly road.

At which position does the cyclist have the least gravitational (potential) energy?

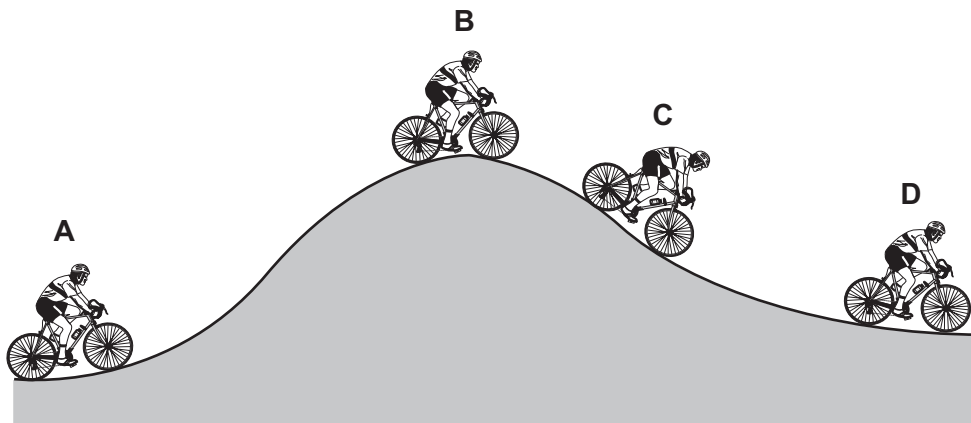

33 Which statement describes the molecules in a gas?

- A They are close together and move about quickly.
- B They are close together and move about slowly.
- C They are far apart and move about quickly.
- D They are far apart and move about slowly.

- 34 On a cold night, two children sit next to a camp fire to warm their hands. Their hands are the same distance from the fire. Child 1 holds his hands over the fire and child 2 holds her hands in front of the fire.

child 1's hands



child 2's hands

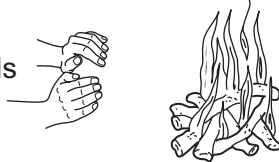

How does the heat from the fire reach each child's hands?

	child 1	child 2
A	convection only	radiation only
B	convection and radiation	radiation only
C	radiation only	convection and radiation
D	radiation only	convection only

- 35 A girl writes the word **LEFT** on a piece of card.



She looks at the image of this card, made by reflection by a plane mirror.

What does she see?

A
B
C
D

LEEF

TFEJ

LEET

TFEL

- 36 The diagram shows a ray of light travelling in glass from point P. Angle x is greater than the critical angle.

In which labelled direction does the ray continue?

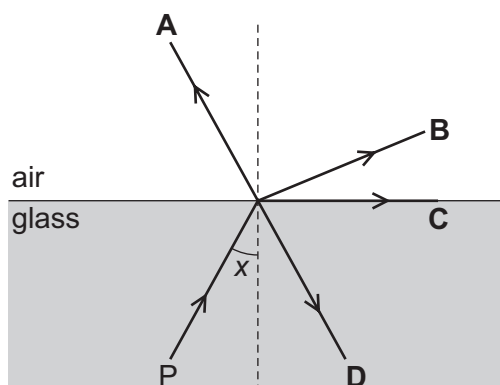

- 37 A student measures the speed of sound. He claps his hands and the sound reflects from a wall which is 100 m away from him.

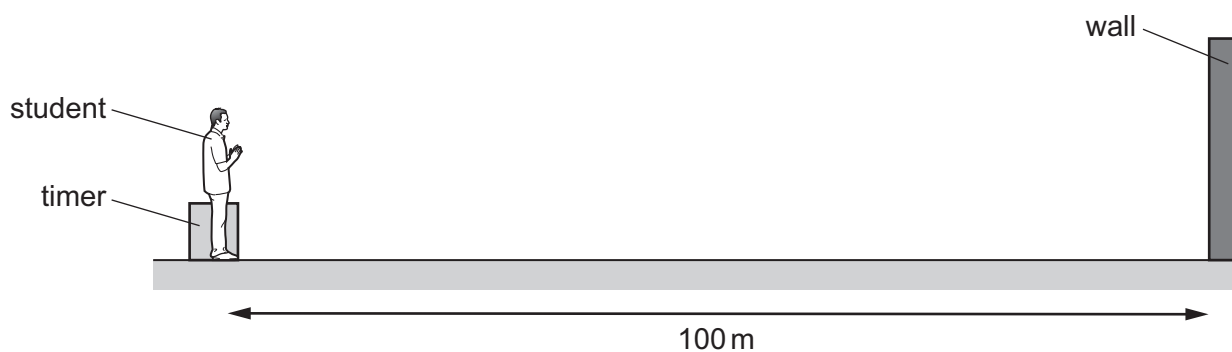

An electronic timer detects the echo of the sound 0.60 s after it is made.

Which calculation should the student use to determine the speed of sound?

- A $\frac{100}{0.60}$ m/s B $\frac{100}{1.2}$ m/s C $\frac{200}{0.30}$ m/s D $\frac{200}{0.60}$ m/s
- 38 A negative ion X is close to a positive ion and another negative ion. Electrical forces act on ion X because of the charges in the other two ions.

Which diagram shows the directions of the two forces acting on ion X?

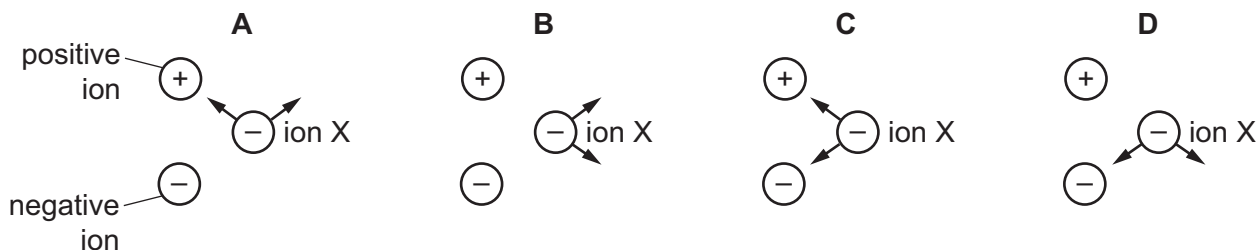

39 The diagram shows a circuit with three ammeters X, Y and Z.

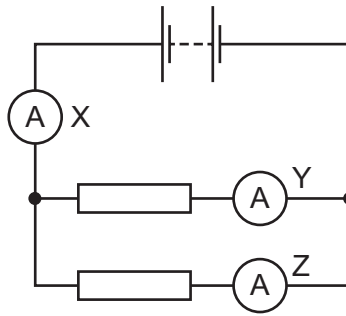

Which set of readings on the ammeters is possible?

	X	Y	Z
A	2A	3A	5A
B	3A	2A	5A
C	3A	3A	3A
D	5A	2A	3A

40 Two identical lamps P and Q are connected in a circuit as shown in the diagram.

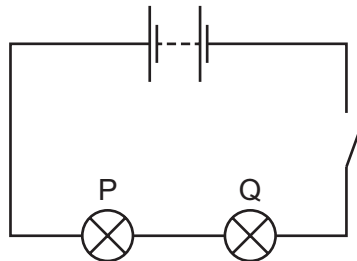

The circuit is now switched on.

Which statement is correct?

- A** Each lamp can be switched off independently.
- B** If lamp Q breaks, lamp P stays alight.
- C** Lamp P is brighter than lamp Q.
- D** The current is the same in both lamps.

BLANK PAGE

BLANK PAGE

DATA SHEET
The Periodic Table of the Elements

Group		III	IV	V	VI	VII	0	
I	II	1 H Hydrogen 1					VII	4 He Helium 2
7 Li Lithium 3	9 Be Beryllium 4						19 F Fluorine 9	20 Ne Neon 10
23 Na Sodium 11	24 Mg Magnesium 12	11 B Boron 5	12 C Carbon 6	14 N Nitrogen 7	16 O Oxygen 8	17 Cl Chlorine 17	40 Ar Argon 18	
39 K Potassium 19	40 Ca Calcium 20	27 Al Aluminium 13	28 Si Silicon 14	31 P Phosphorus 15	32 S Sulfur 16	35.5 Cl Chlorine 17	84 Kr Krypton 36	
85 Rb Rubidium 37	88 Sr Strontium 38	70 Ga Gallium 31	73 Ge Germanium 32	75 As Arsenic 33	79 Se Selenium 34	80 Br Bromine 35	131 Xe Xenon 54	
133 Cs Caesium 55	137 Ba Barium 56	65 Zn Zinc 30	64 Cu Copper 29	106 Pd Palladium 46	112 Cd Cadmium 48	128 Te Tellurium 52	222 Rn Radon 86	
223 Fr Francium 87	226 Ra Radium 88	115 In Indium 49	108 Ag Silver 47	195 Pt Platinum 78	201 Hg Mercury 80	210 Po Polonium 84		
		59 Ni Nickel 28	59 Co Cobalt 27	103 Rh Rhodium 45	192 Ir Iridium 77	209 Bi Bismuth 83		
		55 Mn Manganese 25	56 Fe Iron 26	101 Ru Ruthenium 44	190 Os Osmium 76	207 Pb Lead 82		
		52 Cr Chromium 24	55 Mn Manganese 25	106 Pd Palladium 46	195 Pt Platinum 78			
		51 V Vanadium 23	56 Fe Iron 26	103 Rh Rhodium 45	192 Ir Iridium 77			
		48 Ti Titanium 22	55 Mn Manganese 25	101 Ru Ruthenium 44	190 Os Osmium 76			
		45 Sc Scandium 21	56 Fe Iron 26	106 Pd Palladium 46	195 Pt Platinum 78			
		89 Y Yttrium 39	56 Fe Iron 26	101 Ru Ruthenium 44	190 Os Osmium 76			
		139 La Lanthanum 57	56 Fe Iron 26	101 Ru Ruthenium 44	190 Os Osmium 76			
		178 Hf Hafnium 72	56 Fe Iron 26	101 Ru Ruthenium 44	190 Os Osmium 76			
		181 Ta Tantalum 73	56 Fe Iron 26	101 Ru Ruthenium 44	190 Os Osmium 76			
		184 W Tungsten 74	56 Fe Iron 26	101 Ru Ruthenium 44	190 Os Osmium 76			
		186 Re Rhenium 75	56 Fe Iron 26	101 Ru Ruthenium 44	190 Os Osmium 76			
		227 Ac Actinium 89	56 Fe Iron 26	101 Ru Ruthenium 44	190 Os Osmium 76			
		140 Ce Cerium 58	147 Pm Promethium 61	150 Sm Samarium 62	157 Gd Gadolinium 64	162 Dy Dysprosium 66	165 Ho Holmium 67	
		141 Pr Praseodymium 59	147 Pm Promethium 61	150 Sm Samarium 62	157 Gd Gadolinium 64	162 Dy Dysprosium 66	165 Ho Holmium 67	
		144 Nd Neodymium 60	147 Pm Promethium 61	150 Sm Samarium 62	157 Gd Gadolinium 64	162 Dy Dysprosium 66	165 Ho Holmium 67	
		147 Pm Promethium 61	147 Pm Promethium 61	150 Sm Samarium 62	157 Gd Gadolinium 64	162 Dy Dysprosium 66	165 Ho Holmium 67	
		150 Sm Samarium 62	147 Pm Promethium 61	150 Sm Samarium 62	157 Gd Gadolinium 64	162 Dy Dysprosium 66	165 Ho Holmium 67	
		152 Eu Europium 63	147 Pm Promethium 61	150 Sm Samarium 62	157 Gd Gadolinium 64	162 Dy Dysprosium 66	165 Ho Holmium 67	
		159 Tb Terbium 65	147 Pm Promethium 61	150 Sm Samarium 62	157 Gd Gadolinium 64	162 Dy Dysprosium 66	165 Ho Holmium 67	
		162 Dy Dysprosium 66	147 Pm Promethium 61	150 Sm Samarium 62	157 Gd Gadolinium 64	162 Dy Dysprosium 66	165 Ho Holmium 67	
		167 Er Erbium 68	147 Pm Promethium 61	150 Sm Samarium 62	157 Gd Gadolinium 64	162 Dy Dysprosium 66	165 Ho Holmium 67	
		173 Yb Ytterbium 70	147 Pm Promethium 61	150 Sm Samarium 62	157 Gd Gadolinium 64	162 Dy Dysprosium 66	165 Ho Holmium 67	
		175 Lu Lutetium 71	147 Pm Promethium 61	150 Sm Samarium 62	157 Gd Gadolinium 64	162 Dy Dysprosium 66	165 Ho Holmium 67	
		169 Tm Thulium 69	147 Pm Promethium 61	150 Sm Samarium 62	157 Gd Gadolinium 64	162 Dy Dysprosium 66	165 Ho Holmium 67	
		257 Fm Fermium 100	147 Pm Promethium 61	150 Sm Samarium 62	157 Gd Gadolinium 64	162 Dy Dysprosium 66	165 Ho Holmium 67	
		258 Md Mendelevium 101	147 Pm Promethium 61	150 Sm Samarium 62	157 Gd Gadolinium 64	162 Dy Dysprosium 66	165 Ho Holmium 67	
		260 Lr Lawrencium 103	147 Pm Promethium 61	150 Sm Samarium 62	157 Gd Gadolinium 64	162 Dy Dysprosium 66	165 Ho Holmium 67	

The volume of one mole of any gas is 24 dm³ at room temperature and pressure (r.t.p.).

*58-71 Lanthanoid series
†90-103 Actinoid series

Key

a	X	a = relative atomic mass
b	X	X = atomic symbol
		b = proton (atomic) number