



Cambridge IGCSE™

CANDIDATE
NAME

CENTRE
NUMBER

--	--	--	--	--

CANDIDATE
NUMBER

--	--	--	--

* 2 2 4 4 1 8 0 8 0 6 *



CHEMISTRY

0620/62

Paper 6 Alternative to Practical

October/November 2022

1 hour

You must answer on the question paper.

No additional materials are needed.

INSTRUCTIONS

- Answer **all** questions.
- Use a black or dark blue pen. You may use an HB pencil for any diagrams or graphs.
- Write your name, centre number and candidate number in the boxes at the top of the page.
- Write your answer to each question in the space provided.
- Do **not** use an erasable pen or correction fluid.
- Do **not** write on any bar codes.
- You may use a calculator.
- You should show all your working and use appropriate units.

INFORMATION

- The total mark for this paper is 40.
- The number of marks for each question or part question is shown in brackets [].

This document has **12** pages. Any blank pages are indicated.

- 1 A mixture of three coloured compounds was separated using the apparatus shown in the diagram.

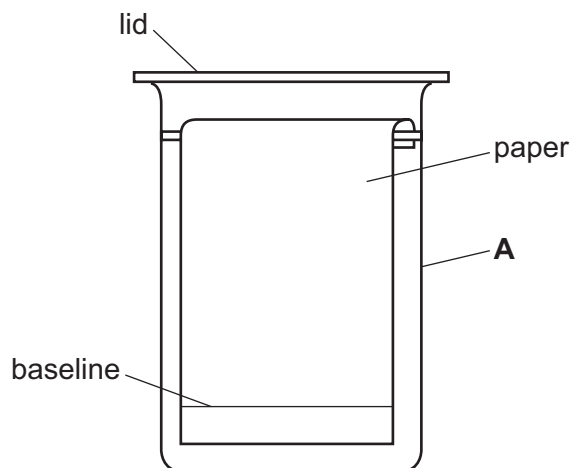

- (a) Give the name of the item of apparatus labelled **A**.

..... [1]

- (b) One drop of the mixture of coloured compounds was placed on the paper and some solvent was poured into **A**.

Draw **on the diagram**:

- a spot (●) to show where the drop of the mixture of coloured compounds should be placed on the paper at the start of the experiment
- a line to show the level of the solvent in **A** at the start of the experiment.

[2]

- (c) Name an item of apparatus that should be used to place a drop of the mixture of coloured compounds onto the paper.

..... [1]

- (d) State when the paper should be removed from the solvent in **A**.

..... [1]

- (e) Name this method of separation of coloured compounds.

..... [1]

[Total: 6]

- 2 A student investigated the temperature change when two different aqueous solutions of sodium hydroxide, solution **G** and solution **H**, reacted with dilute hydrochloric acid.

Two experiments were done.

(a) *Experiment 1*

- A burette was rinsed with distilled water and then with dilute hydrochloric acid.
- The burette was filled with the dilute hydrochloric acid. The hydrochloric acid was then run out through the tap until the level was on the 0.00 cm^3 mark.
- A 50 cm^3 measuring cylinder was used to pour 20 cm^3 of solution **G** into a beaker.
- A thermometer was used to measure the initial temperature of solution **G**.
- 5 cm^3 of dilute hydrochloric acid was added from the burette into the beaker.
- The mixture in the beaker was stirred using the thermometer and the temperature of the mixture was measured.
- Another 5 cm^3 of dilute hydrochloric acid was added from the burette into the beaker.
- The mixture in the beaker was stirred using the thermometer and the temperature of the mixture was measured.
- 5 cm^3 portions of dilute hydrochloric acid continued to be added and the temperature measured until a total of 35 cm^3 of dilute hydrochloric acid had been added.

Experiment 2

- Experiment 1 was repeated using solution **H** instead of solution **G**.

Use the thermometer diagrams to complete the table.

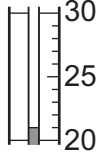
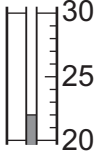
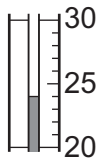
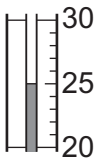
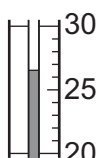
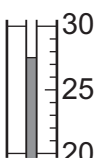
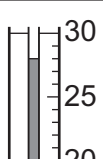
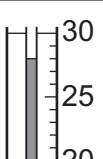
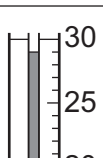
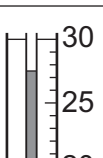
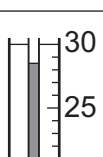
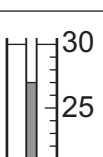
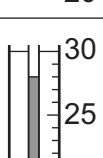
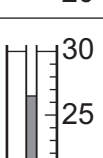
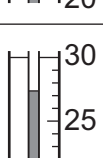
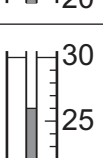
total volume of dilute hydrochloric acid added /cm ³	Experiment 1 using solution G			Experiment 2 using solution H		
	thermometer diagram	temperature /°C	temperature change since start /°C	thermometer diagram	temperature /°C	temperature change since start /°C
0						
5						
10						
15						
20						
25						
30						
35						

[5]

- (b) Complete a suitable scale on the y -axis and plot the results from Experiments 1 and 2 on the grid.

Draw two smooth line graphs. Both curves must start at (0,0). Clearly label your lines.

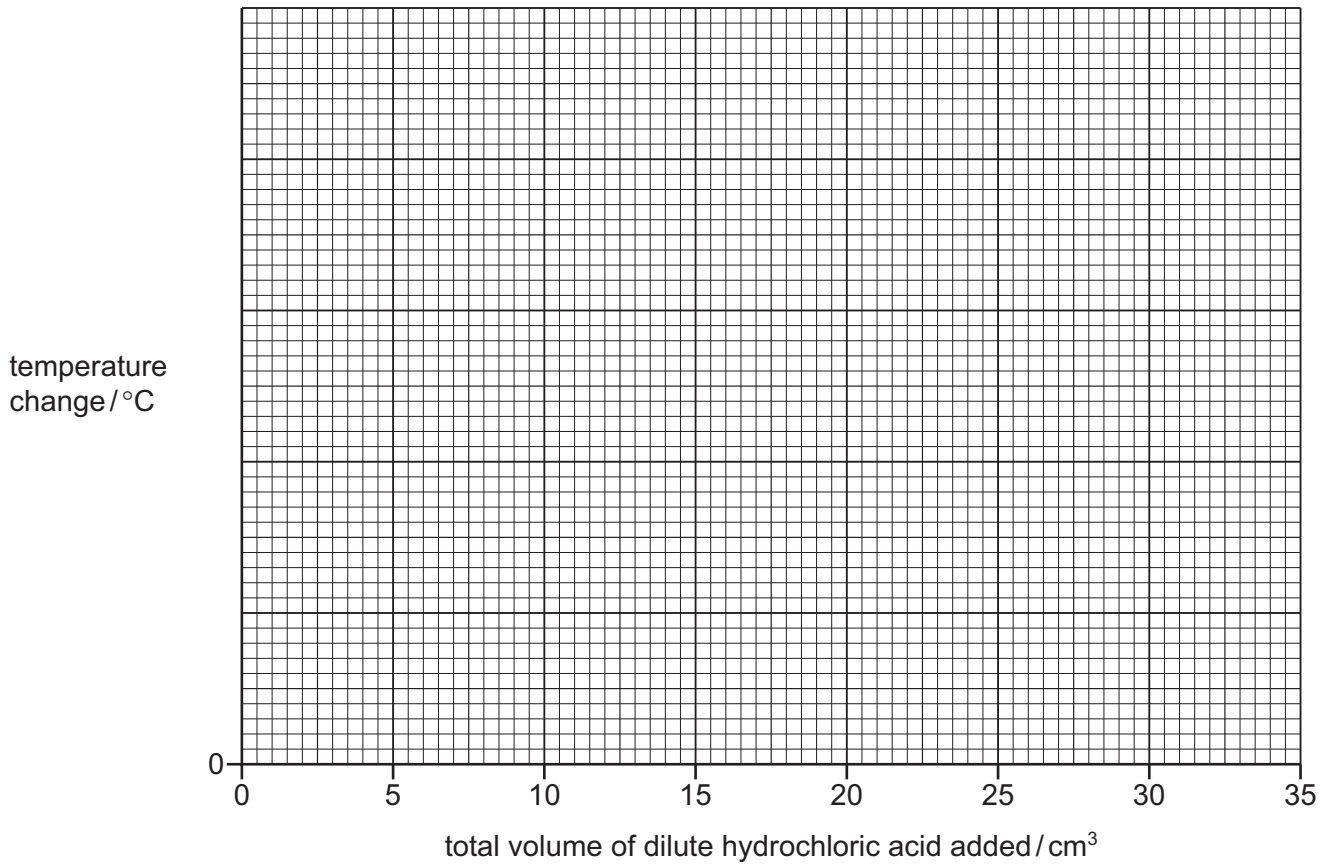

[5]

- (c) **From your graph**, deduce the temperature change obtained when a total volume of 13 cm^3 of dilute hydrochloric acid is added in Experiment 1.

Show clearly **on the grid** how you worked out your answer.

temperature change = °C [2]

- (d) Explain why the temperature change decreases towards the end of each experiment.

.....
 [1]

(e) Explain what conclusion about the concentrations of solution **G** and solution **H** can be made from the results of Experiments 1 and 2.

.....
.....
.....
..... [2]

(f) Explain how the results obtained would be different if a polystyrene cup is used instead of the beaker.

.....
.....
.....
..... [2]

(g) Give an advantage and a disadvantage of using a burette rather than a measuring cylinder to add the dilute hydrochloric acid to solution **G** and solution **H**.

advantage

.....

disadvantage

.....

[2]

[Total: 19]

- 3 Solid **I** and solid **J** were analysed.
Tests were done on each substance.

tests on solid I

tests	observations
test 1 Dilute hydrochloric acid was added to a boiling tube containing solid I . Any gas produced was tested.	 effervescence was seen, the solid dissolved to form a colourless solution the gas turned limewater milky
test 2 A flame test was carried out on the solution formed in test 1 .	 a red flame was seen

- (a) Identify the gas made in **test 1**.

..... [1]

- (b) Identify solid **I**.

.....

..... [2]

tests on solid J

Solid **J** was aluminium chloride.

Solid **J** was dissolved in water to form solution **J**. Solution **J** was divided into four approximately equal portions in four test-tubes.

- (c) Aqueous sodium hydroxide was added dropwise and then in excess to the first portion of solution **J**.

observations

..... [2]

- (d) Aqueous ammonia was added dropwise and then in excess to the second portion of solution **J**.

observations

..... [2]

- (e) About 1 cm depth of dilute nitric acid followed by a few drops of aqueous barium nitrate were added to the third portion of solution **J**.

observations [1]

- (f) About 1 cm depth of dilute nitric acid followed by a few drops of aqueous silver nitrate were added to the fourth portion of solution **J**.

observations [1]

[Total: 9]

BLANK PAGE

BLANK PAGE

BLANK PAGE

Permission to reproduce items where third-party owned material protected by copyright is included has been sought and cleared where possible. Every reasonable effort has been made by the publisher (UCLES) to trace copyright holders, but if any items requiring clearance have unwittingly been included, the publisher will be pleased to make amends at the earliest possible opportunity.

To avoid the issue of disclosure of answer-related information to candidates, all copyright acknowledgements are reproduced online in the Cambridge Assessment International Education Copyright Acknowledgements Booklet. This is produced for each series of examinations and is freely available to download at www.cambridgeinternational.org after the live examination series.

Cambridge Assessment International Education is part of Cambridge Assessment. Cambridge Assessment is the brand name of the University of Cambridge Local Examinations Syndicate (UCLES), which is a department of the University of Cambridge.