



Cambridge IGCSE™

BIOLOGY

0610/22

Paper 2 Multiple Choice (Extended)

October/November 2021

45 minutes

You must answer on the multiple choice answer sheet.

You will need: Multiple choice answer sheet
Soft clean eraser
Soft pencil (type B or HB is recommended)

INSTRUCTIONS

- There are **forty** questions on this paper. Answer **all** questions.
- For each question there are four possible answers **A, B, C** and **D**. Choose the **one** you consider correct and record your choice in soft pencil on the multiple choice answer sheet.
- Follow the instructions on the multiple choice answer sheet.
- Write in soft pencil.
- Write your name, centre number and candidate number on the multiple choice answer sheet in the spaces provided unless this has been done for you.
- Do **not** use correction fluid.
- Do **not** write on any bar codes.
- You may use a calculator.

INFORMATION

- The total mark for this paper is 40.
- Each correct answer will score one mark.
- Any rough working should be done on this question paper.

This document has **16** pages.



- 1 All living things can remove toxic materials and other substances that are in excess of requirements.

What is this process called?

- A egestion
- B excretion
- C nutrition
- D respiration

- 2 Two animals have an identical sequence of amino acids in one of the proteins found in their cells.

What does this indicate about these animals?

- A They have been eating the same types of food.
- B They have not been exposed to substances that cause mutation.
- C They must be members of the same genus.
- D They share an ancestor.

- 3 The diagram shows some tissues in part of a plant root. The arrows represent the movement of water into and across the plant root tissues.

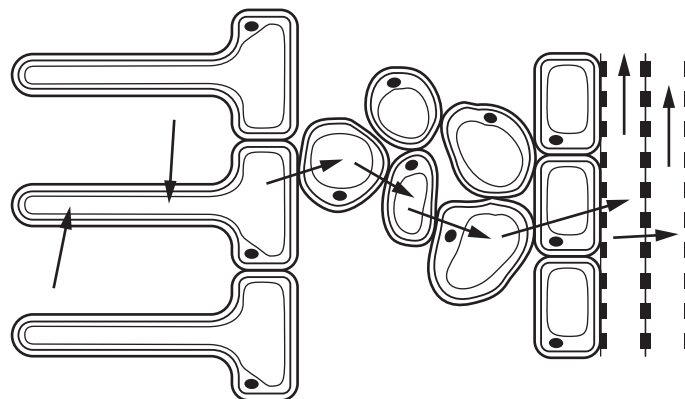

How many different tissues are shown?

- A 2
- B 4
- C 5
- D 7

- 4 The length of a mitochondrion in a photomicrograph is 15 mm.

The actual length of the mitochondrion is 3 μm .

What is the magnification of the photomicrograph?

- A $\times 5$
- B $\times 45$
- C $\times 5000$
- D $\times 45000$

- 5 The diagram shows some cells.

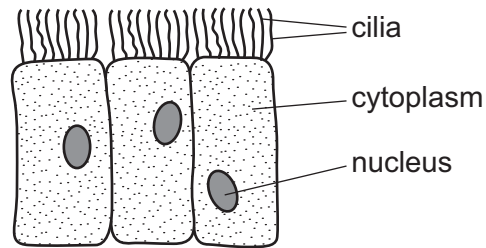

Where are these cells found?

- A alimentary canal
 - B blood
 - C bronchus
 - D plant roots
- 6 Which statement about diffusion is correct?
- A The process requires energy from respiration.
 - B The particles must cross a cell membrane.
 - C The net movement of particles is up a concentration gradient.
 - D The process involves the random movement of particles.
- 7 The diagram shows the uptake of mineral ions by root hair cells.

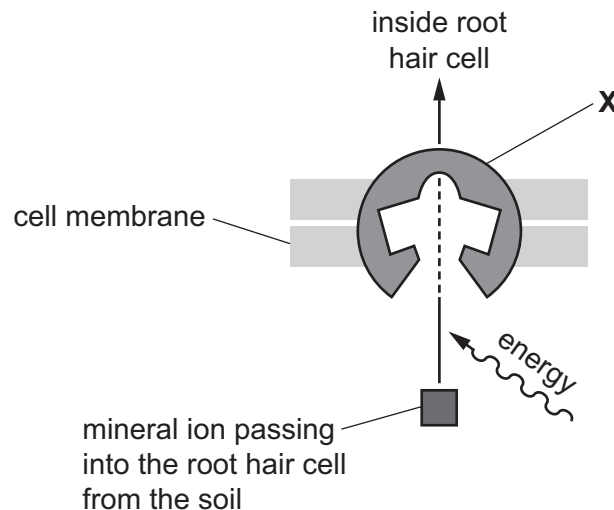

Which type of molecule is labelled **X** in the diagram?

- A glucose
- B lipid
- C protein
- D starch

- 8 The bases on one of the strands of a DNA molecule have the sequence shown.

A-A-T-C-T-G

What is the corresponding sequence of bases on the other strand?

- A** A-A-T-C-T-G
B C-C-G-A-G-T
C G-G-C-T-C-A
D T-T-A-G-A-C
- 9 In a photosynthesis experiment, a plant is left in bright sunlight for several hours. A leaf is then removed from the plant and tested for starch, using iodine solution.

The diagram shows the leaf from the plant that was used in the experiment.

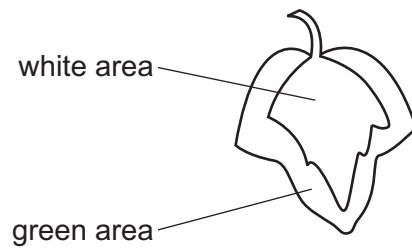

Which diagram shows the result of the experiment?

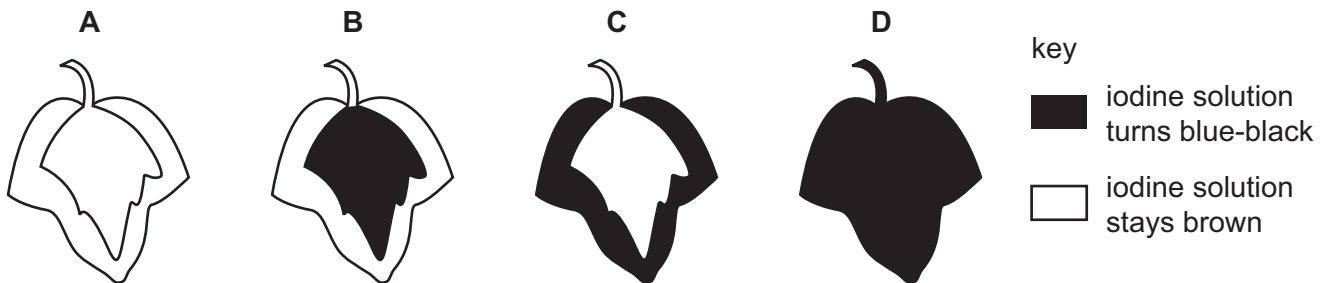

- 10 An experiment was carried out to investigate the effect of pH on enzyme action. The graph shows the results.

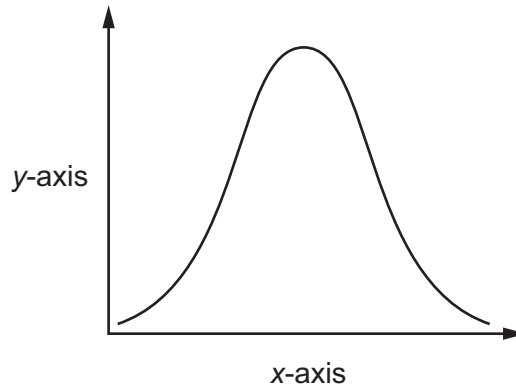

What are the labels for the x-axis and the y-axis?

	x-axis	y-axis
A	pH	rate of reaction
B	pH	time
C	rate of reaction	pH
D	time	pH

- 11 Four test-tubes were set up as shown in the diagram.

In which test-tube is the starch digested most quickly?

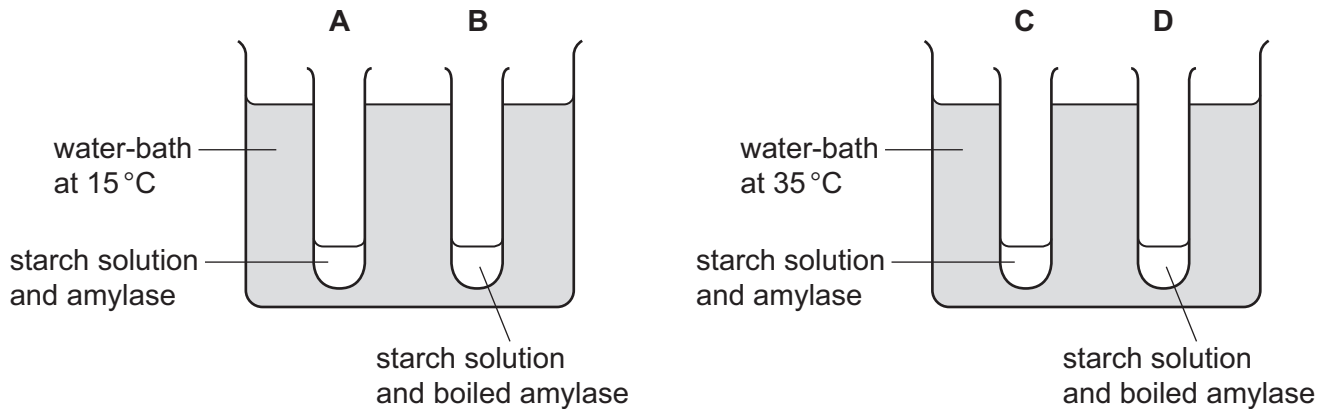

- 12 Two similar leaves are set up in test-tubes as shown. One is exposed to light, while the other is kept in the dark.

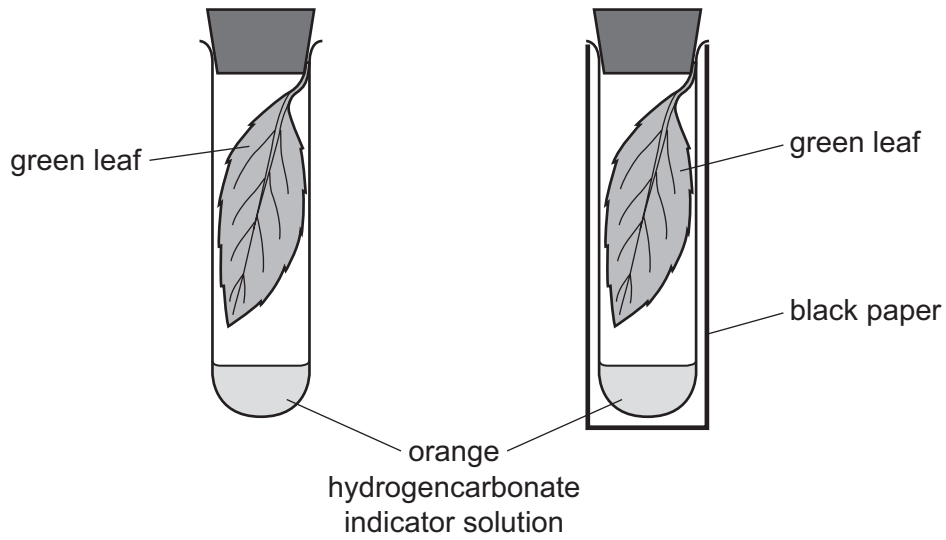

After a few hours, which colour would the hydrogencarbonate indicator solution be in each test-tube?

	light	dark
A	colourless	blue-black
B	purple	yellow
C	red	blue
D	yellow	purple

- 13 The diagram shows the surface view of part of the epidermis of a leaf.

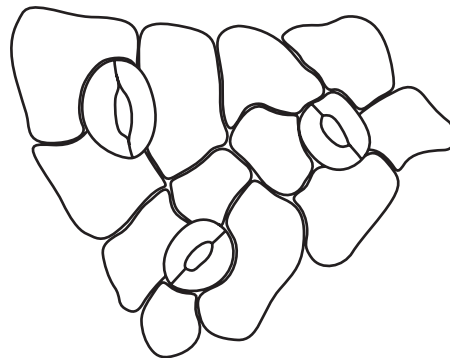

How many guard cells are present?

- A** 0 **B** 3 **C** 6 **D** 12

14 The diagram shows part of the alimentary canal and associated organs.

Where does most water absorption take place?

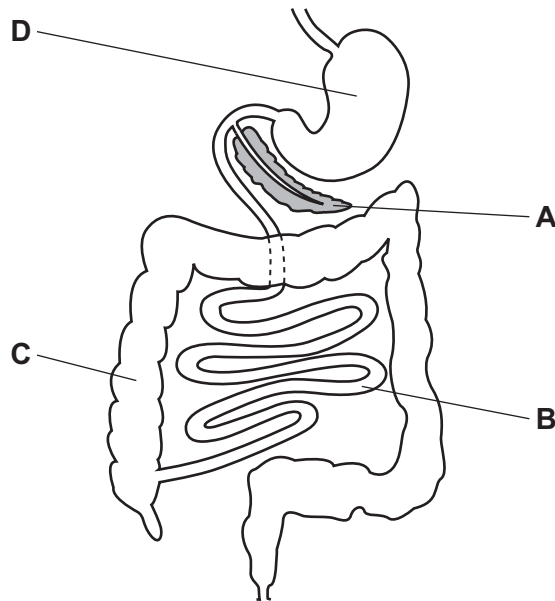

15 The diagram shows a large food molecule changing into smaller molecules.

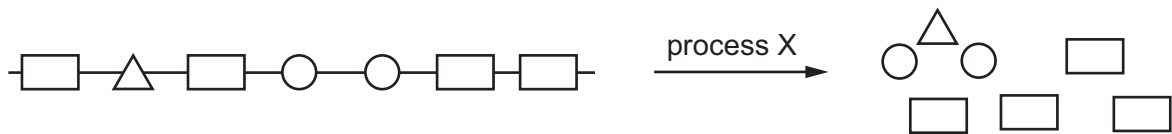

What is process X?

- A absorption
- B chewing
- C digestion
- D secretion

- 16 The diagram shows a newly planted seedling and the same seedling a few hours after being planted.

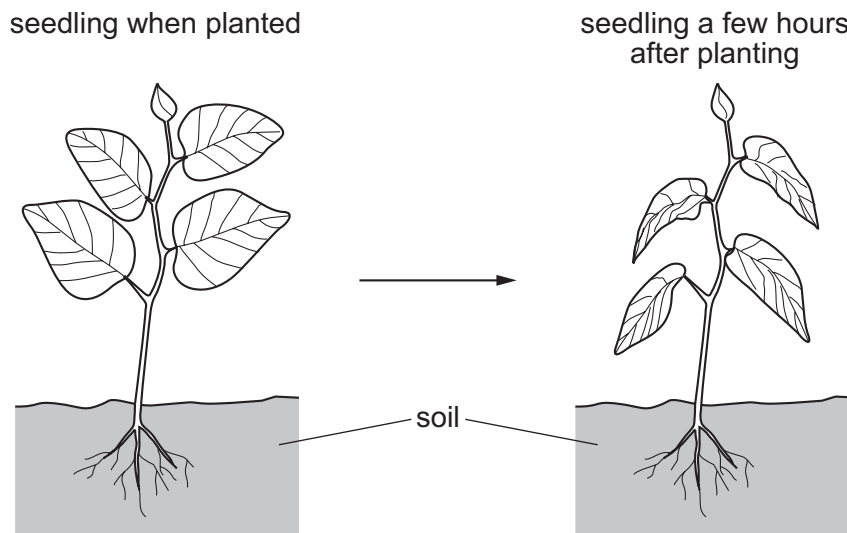

What is the correct explanation for the change in the appearance of the leaves?

- A Transpiration is faster than water uptake by root hairs so cells have become flaccid.
 - B Transpiration is faster than water uptake by root hairs so cells have become turgid.
 - C Transpiration is slower than water uptake by root hairs so cells have become flaccid.
 - D Transpiration is slower than water uptake by root hairs so cells have become turgid.
- 17 Translocation is the movement of sucrose and amino acids in the phloem tissue of a plant from source to sink.

Which organ can act as a source?

- A flower
 - B growing shoot tip
 - C new developing root
 - D storage root
- 18 Which component of blood produces antibodies?
- A lymphocytes
 - B phagocytes
 - C plasma
 - D red blood cells

19 What do shunt vessels connect?

- A arterioles to capillaries
- B arterioles to venules
- C capillaries to lymphatic vessels
- D capillaries to venules

20 Which graph shows how the pressure inside the lungs changes when taking one breath in?

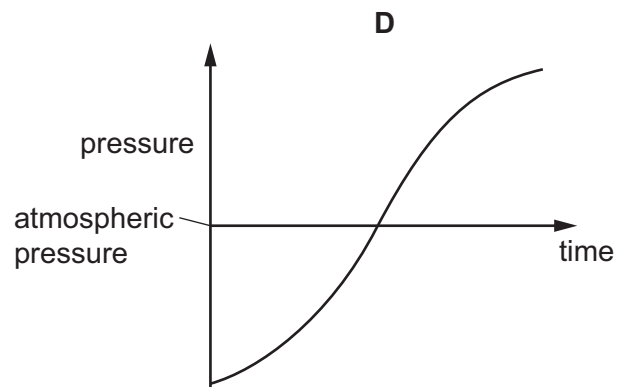
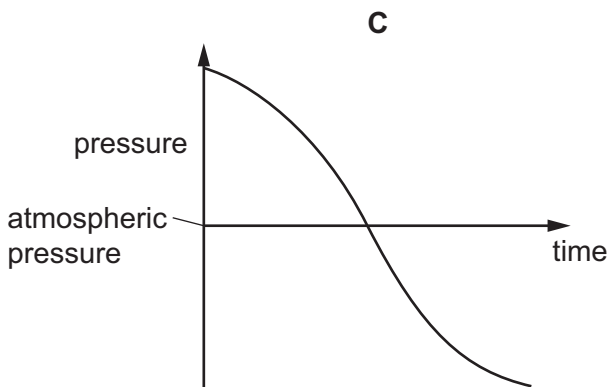
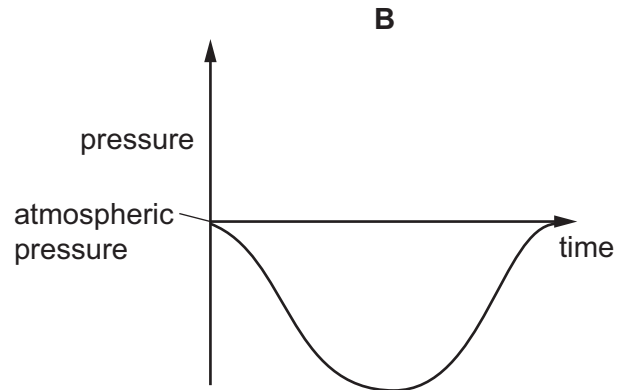
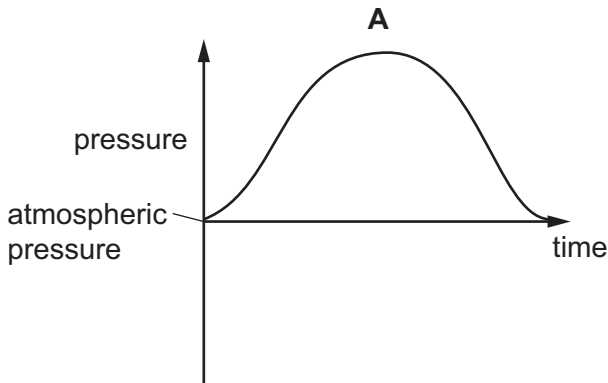

21 Some features that help to defend the body against pathogens are listed.

- 1 mucus
- 2 skin
- 3 stomach acid
- 4 phagocytosis

Which features can prevent pathogens entering body tissues?

- A 1, 2, 3 and 4
- B 1, 2 and 3 only
- C 2 and 3 only
- D 4 only

- 22 The diagram shows the apparatus used to measure the rate of respiration in germinating seeds. As the seeds respire, the bubble of coloured water moves along the glass tube.

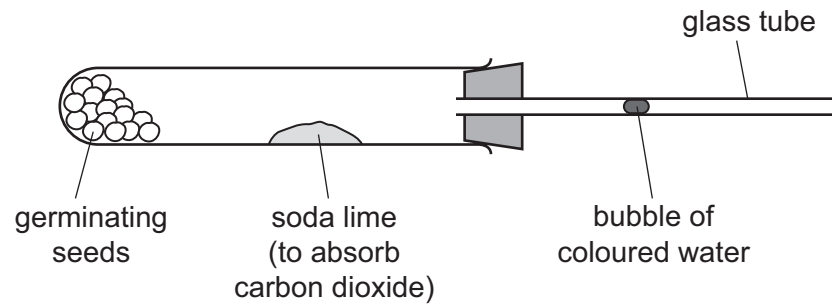

The temperature is increased from 20 °C to 40 °C.

What happens to the movement of the bubble as the temperature increases?

- A The bubble moves more quickly towards the seeds at 40 °C than at 20 °C.
 - B The bubble moves more quickly away from the seeds at 40 °C than at 20 °C.
 - C The bubble moves more quickly towards the seeds at 20 °C than at 40 °C.
 - D The bubble moves more quickly away from the seeds at 20 °C than at 40 °C.
- 23 Which statement about lactic acid is correct?
- A Lactic acid is a product of anaerobic respiration in yeast.
 - B Lactic acid build-up in tissues can lead to an oxygen debt.
 - C Lactic acid is produced from sucrose during anaerobic respiration.
 - D Lactic acid is transported from the liver to the muscles after exercise.

24 The diagram shows a mammalian kidney.

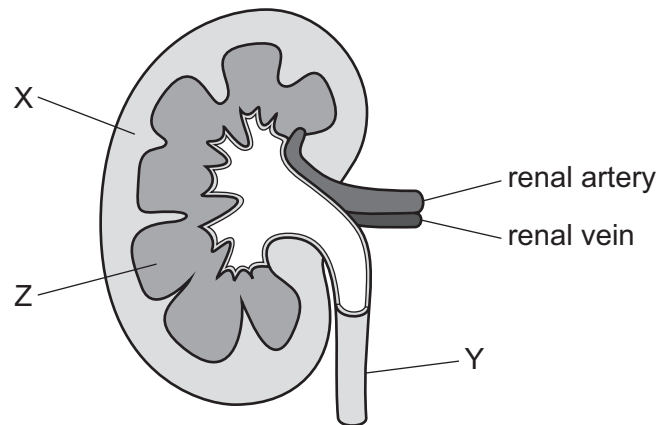

What are areas X, Y and Z?

	X	Y	Z
A	cortex	medulla	ureter
B	cortex	ureter	medulla
C	medulla	cortex	ureter
D	medulla	ureter	medulla

25 The structures listed are part of the nervous system.

- 1 brain
- 2 effector
- 3 receptor
- 4 relay neurone

In a reflex arc, which structures are connected to a motor neurone by synapses?

- A** 1 and 2 **B** 1 and 3 **C** 2 and 4 **D** 3 and 4

26 Which process is a response of the body that is part of a negative feedback process?

- A** release of insulin in response to low blood glucose concentration
B vasoconstriction in response to an increase in blood temperature
C synthesis of glycogen in response to increase in blood glucose concentration
D sweating in response to a decrease in blood temperature

27 Which row shows the pupil reflex in bright light?

	muscles in iris		size of pupil
	circular	radial	
A	contracts	relaxes	larger
B	contracts	relaxes	smaller
C	relaxes	contracts	larger
D	relaxes	contracts	smaller

28 A seed is placed and grown on a rotating disc, as shown.

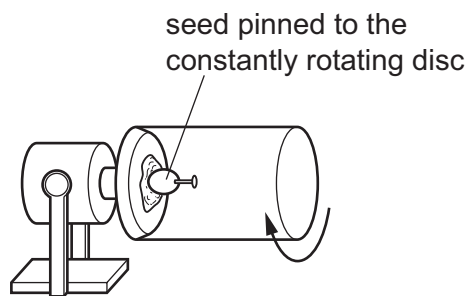

Which diagram shows the appearance of the seedling shoot after seven days?

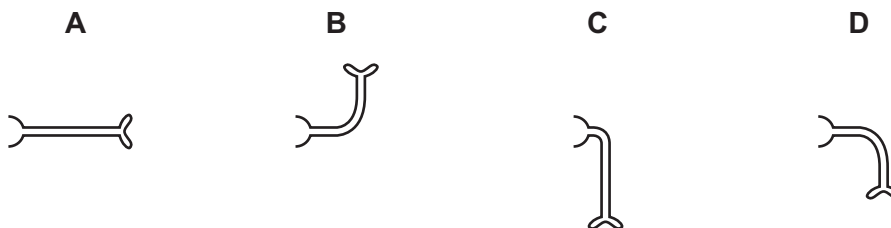

29 Commercial plant growers use asexual reproduction to grow coffee plants which produce crops of coffee beans.

What is a disadvantage of asexual reproduction?

- A** The coffee beans produced by all of the plants are identical.
- B** Two parent plants are needed.
- C** One parent is needed.
- D** All plants are equally susceptible to the same disease.

30 Which statement about the human immunodeficiency virus (HIV) is correct?

- A Antibodies cannot be made.
- B HIV infections can be treated with antibiotics.
- C HIV destroys lymphocytes.
- D HIV is spread by coughing and sneezing.

31 Which statement about a diploid human cell is correct?

- A There are 22 chromosomes and an X or a Y chromosome.
- B There are 22 pairs of chromosomes and two sex chromosomes.
- C There are 23 chromosomes.
- D There are 23 pairs of chromosomes and two sex chromosomes.

32 The gene for haemophilia is found on the X chromosome and the allele for haemophilia is recessive.

In the pedigree diagram the dominant allele is shown as X^H and the recessive allele is shown as X^h .

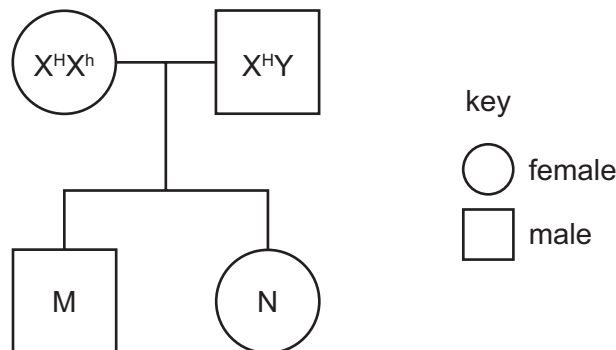

What is the probability of child M having haemophilia?

- A 0.00
- B 0.25
- C 0.50
- D 1.00

33 What is an adaptive feature of xerophytes?

- A They do not have root hair cells.
- B Their leaves have a large surface area.
- C They have many stomata.
- D Their leaves have thick cuticles.

34 The graph shows the growth of a bacterial population.

Which section represents the exponential (log) phase?

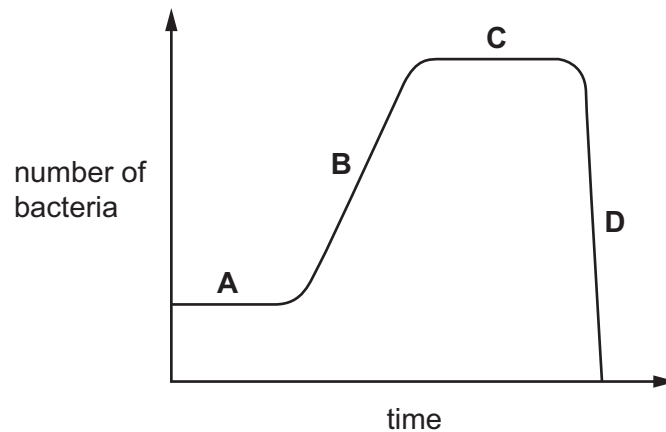

35 A species of insect usually has pale-coloured wings. This helps to camouflage them on pale-coloured tree trunks. A few of the insects in this species have darker coloured wings.

After a number of years the tree trunks become darker in colour due to environmental changes. The insects with dark-coloured wings become more common than insects with pale-coloured wings in this species.

Which process causes this change in the proportion of insects with dark-coloured wings?

- A biotechnology
- B conservation
- C natural selection
- D selective breeding

36 The diagram shows part of the nitrogen cycle.

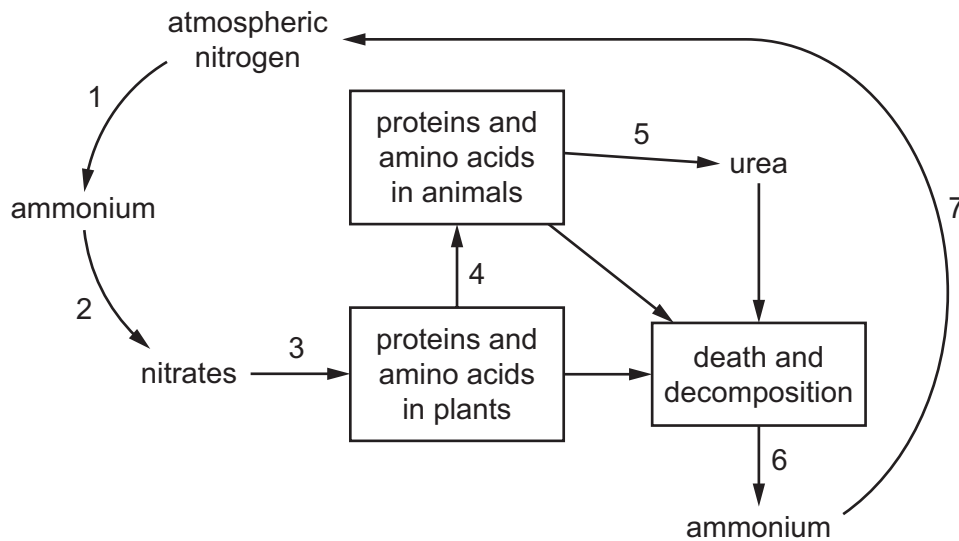

Which processes are carried out by bacteria?

- A 1, 2, 3 and 4
 - B 1, 2, 4 and 5
 - C 1, 2, 5 and 6
 - D 1, 2, 6 and 7
- 37 What is a characteristic of bacteria that makes them useful in genetic engineering?
- A The genetic code of bacteria is different to plants and animals.
 - B Their nucleus contains DNA.
 - C Plasmids can be transferred between cells.
 - D They have large numbers of mitochondria.
- 38 What is the useful product of anaerobic respiration in the manufacture of bread?
- A carbon dioxide
 - B ethanol
 - C lactic acid
 - D oxygen

39 What are reasons why species become endangered?

- A habitat destruction, hunting and introduced species
- B habitat protection, introduced species and monitoring
- C habitat destruction, hunting and captive breeding programmes
- D hunting, pollution and seed banks

40 If the nitrate concentration in a lake increases, fish may die due to the events listed.

- 1 increased aerobic respiration by decomposers
- 2 increased decomposition of dead producers
- 3 increased growth of producers
- 4 reduction in dissolved oxygen

Which sequence of events would lead to the death of the fish?

- A 1 → 3 → 2 → 4
- B 2 → 1 → 4 → 3
- C 3 → 2 → 1 → 4
- D 3 → 4 → 1 → 2

Permission to reproduce items where third-party owned material protected by copyright is included has been sought and cleared where possible. Every reasonable effort has been made by the publisher (UCLES) to trace copyright holders, but if any items requiring clearance have unwittingly been included, the publisher will be pleased to make amends at the earliest possible opportunity.

To avoid the issue of disclosure of answer-related information to candidates, all copyright acknowledgements are reproduced online in the Cambridge Assessment International Education Copyright Acknowledgements Booklet. This is produced for each series of examinations and is freely available to download at www.cambridgeinternational.org after the live examination series.

Cambridge Assessment International Education is part of the Cambridge Assessment Group. Cambridge Assessment is the brand name of the University of Cambridge Local Examinations Syndicate (UCLES), which itself is a department of the University of Cambridge.