



Cambridge International AS & A Level

CHEMISTRY

9701/12

Paper 1 Multiple Choice

February/March 2020

1 hour

You must answer on the multiple choice answer sheet.

You will need: Multiple choice answer sheet
Soft clean eraser
Soft pencil (type B or HB is recommended)
Data booklet

INSTRUCTIONS

- There are **forty** questions on this paper. Answer **all** questions.
- For each question there are four possible answers **A, B, C** and **D**. Choose the **one** you consider correct and record your choice in soft pencil on the multiple choice answer sheet.
- Follow the instructions on the multiple choice answer sheet.
- Write in soft pencil.
- Write your name, centre number and candidate number on the multiple choice answer sheet in the spaces provided unless this has been done for you.
- Do **not** use correction fluid.
- Do **not** write on any bar codes.
- You may use a calculator.

INFORMATION

- The total mark for this paper is 40.
- Each correct answer will score one mark. A mark will not be deducted for a wrong answer.
- Any rough working should be done on this question paper.

This document has **16** pages. Blank pages are indicated.



Section A

For each question there are four possible answers **A**, **B**, **C** and **D**. Choose the **one** you consider to be correct.

Use of the Data Booklet may be appropriate for some questions.

- 1 What number of protons, neutrons and electrons are present in the ion $^{54}\text{Fe}^{3+}$?

	protons	neutrons	electrons
A	26	28	23
B	26	28	29
C	29	25	23
D	29	25	26

- 2 For which hydrocarbon are the molecular and empirical formulae the same?

- A** butane
B ethane
C pent-1-ene
D propane

- 3 Which molecule does **not** have any 90° or 180° bond angles?

- A** C_2H_6 **B** CO_2 **C** PF_5 **D** SF_6

- 4 The following data are needed for this question.

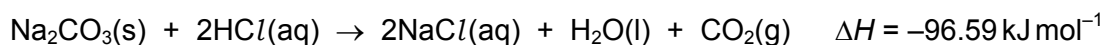

On heating, sodium hydrogencarbonate decomposes as shown.

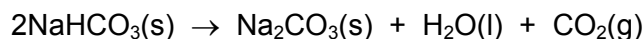

What is the enthalpy change for this decomposition?

- A** $-57.62 \text{ kJ mol}^{-1}$
B $-18.65 \text{ kJ mol}^{-1}$
C $18.65 \text{ kJ mol}^{-1}$
D $57.62 \text{ kJ mol}^{-1}$

- 5 In the redox reaction shown, how do the oxidation states of vanadium and sulfur change?

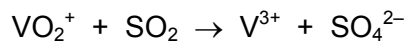

	vanadium		sulfur	
	from	to	from	to
A	+1	+3	0	-2
B	+1	+3	+4	+6
C	+5	+3	0	-2
D	+5	+3	+4	+6

- 6 The equation for the reaction between silver chloride and aqueous ammonia is shown.

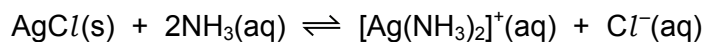

What are the units of K_c for this reaction?

- A** no units **B** $\text{mol}^{-1} \text{dm}^3$ **C** mol dm^{-3} **D** $\text{mol}^2 \text{dm}^{-6}$
- 7 Sodium azide, NaN_3 , decomposes as shown.

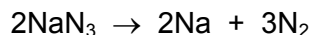

Which volume of nitrogen, measured at room temperature and pressure, will be produced by the decomposition of 150 g of sodium azide?

- A** 166 dm^3 **B** 83 dm^3 **C** 55 dm^3 **D** 37 dm^3
- 8 A stable ion N_5^+ has been produced by research chemists.

Which structure is most likely to show the electron arrangement of this ion?

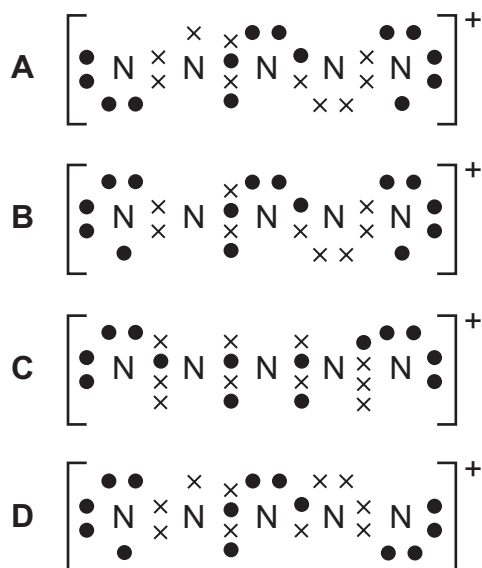

- 9 1.8 g of water, heated to 227 °C in a sealed container, turns to steam with a pressure of 200 kPa.

What is the approximate volume of the container?

- A $9 \times 10^{-4} \text{ m}^3$ B $2 \times 10^{-3} \text{ m}^3$ C 2 m^3 D $8 \times 10^7 \text{ m}^3$

- 10 When the equation is correctly balanced, what is the value of c ?



- A 3 B 4 C 5 D 6

- 11 The main stage in the Contact process is an equilibrium reaction.

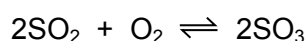

Which row describes the effect of the named condition on the equilibrium yield?

	presence of catalyst	high pressure	high temperature
A	no effect on yield	decreases yield	increases yield
B	no effect on yield	increases yield	decreases yield
C	increases yield	decreases yield	increases yield
D	increases yield	increases yield	decreases yield

- 12 X and Y are oxides of different Period 3 elements.

If one mole of X is added to water, the solution formed is neutralised by exactly one mole of Y.

What could be the identities of X and Y?

	X	Y
A	P_4O_{10}	Al_2O_3
B	SO_3	Al_2O_3
C	P_4O_{10}	Na_2O
D	SO_3	Na_2O

- 13 Compound Z is insoluble in water but soluble at low pH.

What could be compound Z?

- A barium carbonate
- B barium chloride
- C barium hydroxide
- D barium sulfate

- 14 Hot aqueous sodium hydroxide reacts with chlorine.



Which statement is correct?

- A The oxidation numbers of chlorine and hydrogen both change in the reaction.
 - B The oxidation numbers of chlorine in the products are -1 and $+1$.
 - C If the aqueous sodium hydroxide is cold the reaction produces NaClO instead of NaClO_3 .
 - D Sodium undergoes disproportionation in this reaction.
- 15 Solid ammonium nitrate is put into a test-tube and solution X is added to it. The resulting mixture is warmed and the gas given off is tested with damp red litmus paper. The litmus paper changes colour from red to blue.

What could be the identity of X and its role in the reaction?

	identity of X	role of X
A	$\text{NaOH}(\text{aq})$	proton donor
B	$\text{NaOH}(\text{aq})$	proton acceptor
C	$\text{HCl}(\text{aq})$	proton donor
D	$\text{HCl}(\text{aq})$	proton acceptor

- 16 Sodium, magnesium and aluminium are three elements in Period 3 of the Periodic Table. Each element forms an oxide.

Which row is correct?

	sodium oxide	magnesium oxide	aluminium oxide
A	basic	amphoteric	amphoteric
B	giant ionic	giant ionic	simple molecular
C	high melting point	high melting point	low melting point
D	readily reacts with water	slight reaction with water	no reaction with water

17 A student investigates calcium nitrate crystals by heating them in the apparatus shown.

A colourless gas leaves the apparatus at Y. A flame is held to this gas.

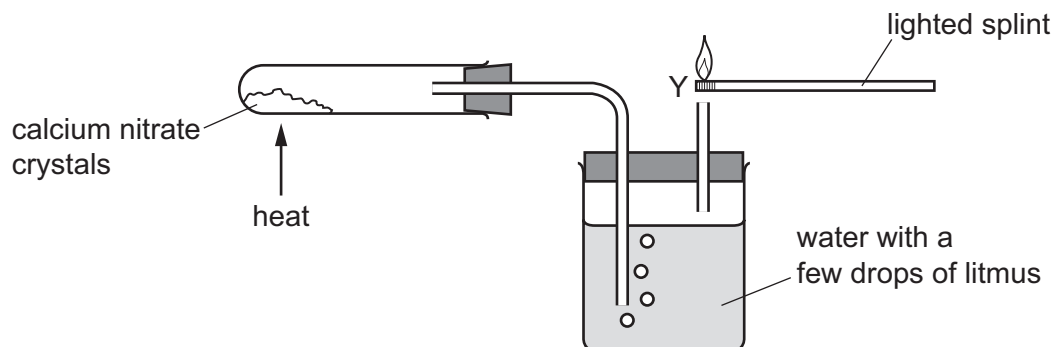

Which observations would the student make?

	litmus solution	flame at Y
A	changes to blue	flame burns more brightly
B	changes to blue	flame goes out
C	changes to red	flame burns more brightly
D	changes to red	flame goes out

18 How does concentrated sulfuric acid behave when it reacts with sodium chloride?

- A** as an acid only
- B** as an acid and oxidising agent
- C** as an oxidising agent only
- D** as a reducing agent only

19 Which statement about nitrogen or its compounds is correct?

- A** In the Haber process the temperature is kept high to give a good equilibrium yield of ammonia.
- B** Nitrogen gas is unreactive because of the strong nitrogen–nitrogen double bond.
- C** Nitrogen monoxide will react with carbon monoxide under suitable conditions.
- D** The formula of ammonium sulfate is NH_4SO_4 .

20 Which pair of compounds are functional group isomers of each other?

- A** butan-1-ol and butanal
- B** ethylpropanoate and pentanoic acid
- C** hex-1-ene and hex-2-ene
- D** propylamine and propanenitrile

- 21 Which row identifies a suitable starting material and reagent that can be used to produce butanenitrile?

	starting material	reagent
A	$\text{CH}_3\text{CH}_2\text{CH}_2\text{Br}$	HCN
B	$\text{CH}_3\text{CH}_2\text{CH}_2\text{Br}$	NaCN
C	$\text{CH}_3\text{CH}_2\text{CH}_2\text{CH}_2\text{Br}$	HCN
D	$\text{CH}_3\text{CH}_2\text{CH}_2\text{CH}_2\text{Br}$	NaCN

- 22 The diagram shows the structure of ethanedioic acid.

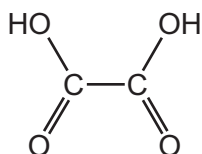

Ethanedioic acid reacts with ethanol in the presence of a few drops of concentrated sulfuric acid to form a diester. The molecular formula of the diester is $\text{C}_6\text{H}_{10}\text{O}_4$.

What is the structural formula of the diester?

- A** $\text{CH}_3\text{CH}_2\text{CO}_2\text{CO}_2\text{CH}_2\text{CH}_3$
B $\text{CH}_3\text{CH}_2\text{OCOCO}_2\text{CH}_2\text{CH}_3$
C $\text{CH}_3\text{CH}_2\text{O}_2\text{CO}_2\text{CCH}_2\text{CH}_3$
D $\text{CH}_3\text{CO}_2\text{CH}_2\text{CH}_2\text{OCOCH}_3$

23 The infrared spectrum shown was obtained from a compound J.

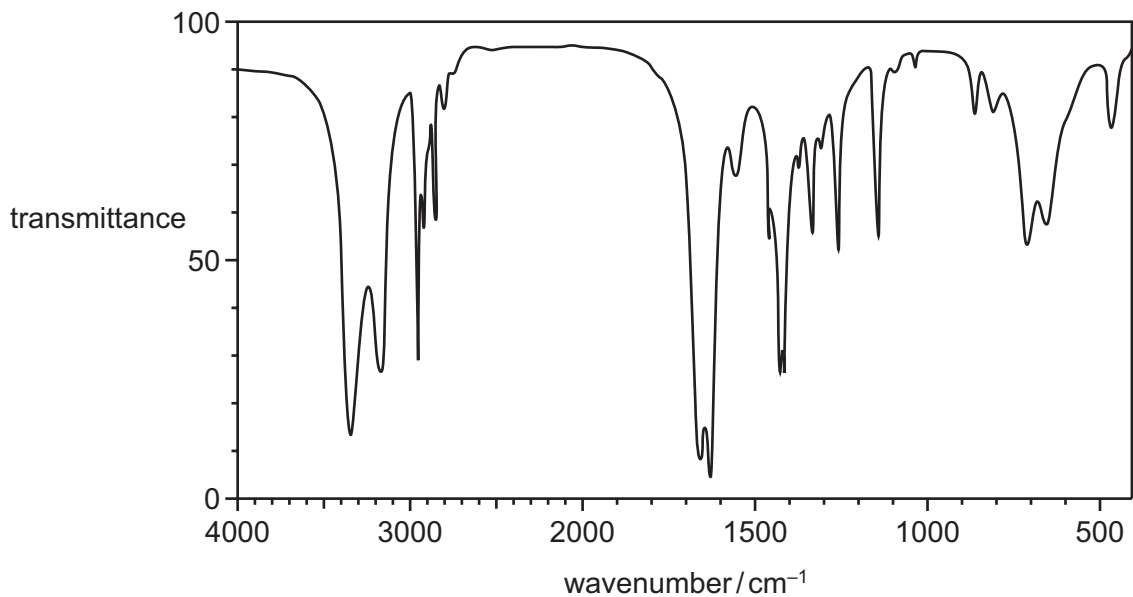

Which statement about J is correct?

- A Both C=O and C≡N are present.
- B Neither C=O nor C≡N are present.
- C C=O is present but not C≡N.
- D C≡N is present but not C=O.

24 A section of a polymer chain is shown.

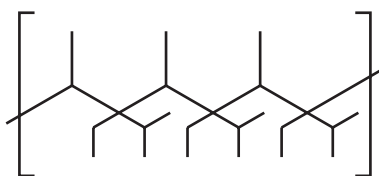

What is the correct monomer?

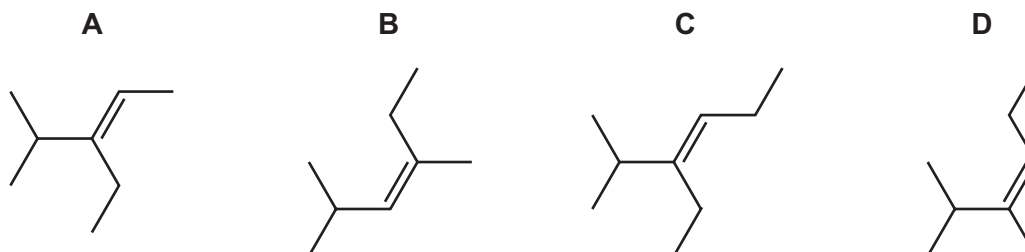

25 Structural isomerism and stereoisomerism should be considered when answering this question.

How many non-cyclic isomers have the molecular formula C₅H₁₀?

- A 3
- B 4
- C 5
- D 6

26 An excess of dry HBr is warmed with compound Y.

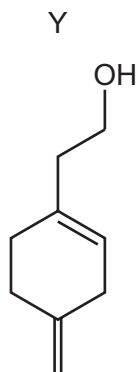

What is the major product of the reaction?

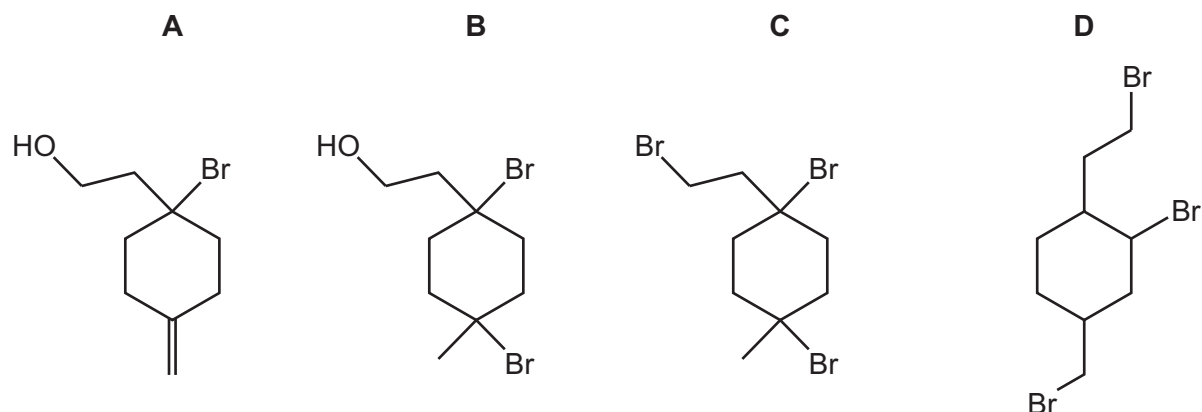

27 Which reaction would produce propanoic acid as one of its products?

- A** heating $(\text{CH}_3)_2\text{C}=\text{CHCH}_2\text{CH}_3$ with concentrated, acidified KMnO_4
- B** heating $\text{CH}_3\text{CH}_2\text{CO}_2\text{CH}_2\text{CH}_2\text{CH}_3$ with $\text{NaOH}(\text{aq})$
- C** heating $\text{CH}_3\text{CH}_2\text{OH}$ with acidified $\text{K}_2\text{Cr}_2\text{O}_7$ under reflux
- D** reacting CH_3CHO with HCN then heating the organic product with $\text{H}_2\text{SO}_4(\text{aq})$

- 28 Compound X is treated with an excess of lithium aluminium hydride. The reaction is allowed to go to completion.

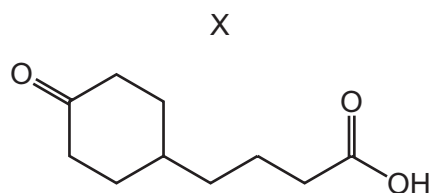

What is the structure of the organic product?

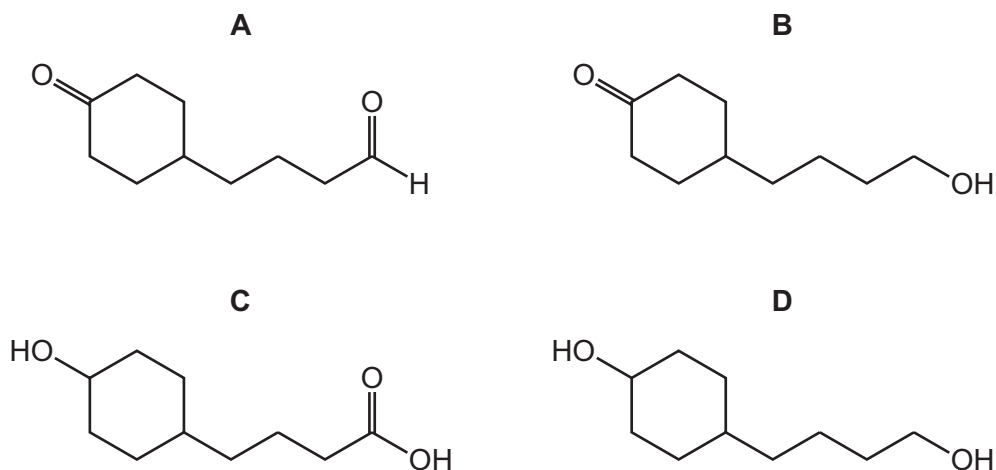

- 29 What is the skeletal formula of the compound formed when $\text{CH}_3\text{CH}=\text{CHCH}_2\text{OH}$ is heated, under reflux, with $\text{K}_2\text{Cr}_2\text{O}_7/\text{H}^+$?

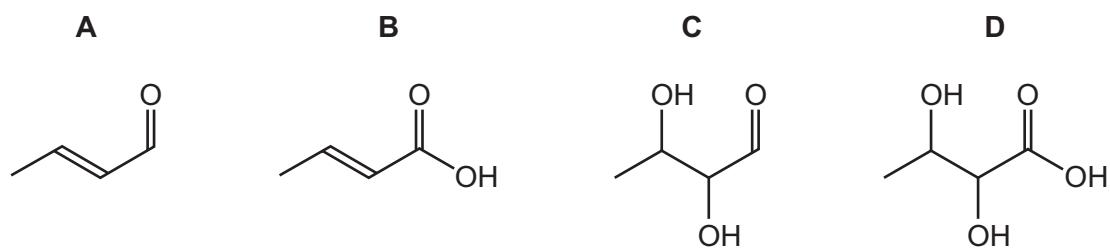

30 The diagram shows the structure of compound Q.

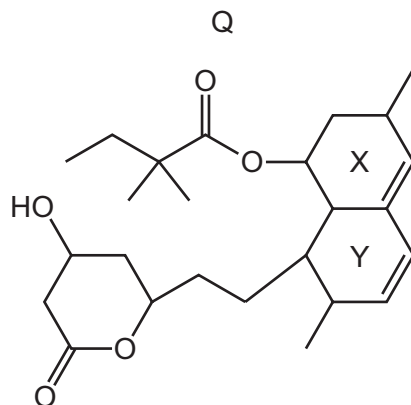

Two of the rings, X and Y, contain a C=C bond.

Which row is correct?

	number of ester groups in one molecule of Q	description of rings X and Y
A	1	both are planar
B	1	neither is planar
C	2	both are planar
D	2	neither is planar

Section B

For each of the questions in this section, one or more of the three numbered statements **1** to **3** may be correct.

Decide whether each of the statements is or is not correct (you may find it helpful to put a tick against the statements that you consider to be correct).

The responses **A** to **D** should be selected on the basis of

A	B	C	D
1, 2 and 3 are correct	1 and 2 only are correct	2 and 3 only are correct	1 only is correct

No other combination of statements is used as a correct response.

Use of the Data Booklet may be appropriate for some questions.

31 Carbon and nitrogen are adjacent in the Periodic Table.

Which properties do they both have?

- 1** There is an empty 2p orbital in each atom of the element.
- 2** The principal quantum number of the highest occupied orbital is 2.
- 3** They can form compounds in which their atoms form four bonds.

32 The strong hydrogen bonding present in liquid water causes an increase in which properties?

- 1** viscosity
- 2** boiling point
- 3** surface tension

33 A reaction between carbon and oxygen is shown.

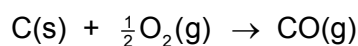

How can the standard enthalpy change of this reaction be described correctly?

- 1** standard enthalpy change of formation
- 2** standard enthalpy change of combustion
- 3** standard enthalpy change of atomisation

34 Hydrochloric acid reacts with zinc.

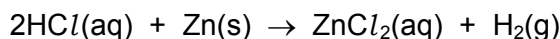

What will increase the rate of this reaction but will **not** change the Boltzmann distribution of molecular energies?

- 1 addition of a suitable catalyst
- 2 an increase in concentration of hydrochloric acid
- 3 an increase in temperature of hydrochloric acid

35 The element astatine, At, is below iodine in Group 17 of the Periodic Table.

Which statements concerning At are likely to be correct?

- 1 It is a dark-coloured solid at room temperature.
- 2 It is a more powerful oxidising agent than iodine.
- 3 Its hydride is more thermally stable than HBr.

36 Which statements are correct?

- 1 Aluminium chloride dissolves in water to give an acidic solution.
- 2 Magnesium chloride dissolves in water to give a solution of pH close to 7.
- 3 Sodium chloride dissolves in water to give an alkaline solution.

37 Ethanal and hydrogen cyanide react together. The reaction mechanism involves cyanide ions.

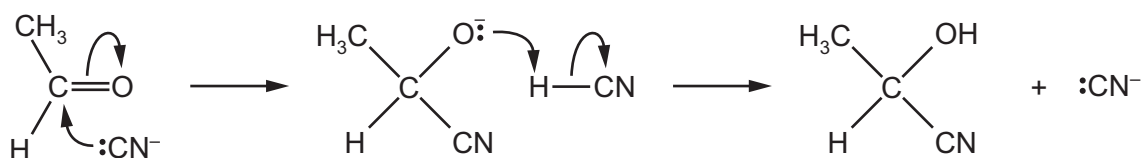

Which statements about this mechanism are correct?

- 1 CN^- acts as a catalyst.
- 2 CN^- is a nucleophile.
- 3 It is an addition reaction.

The responses **A** to **D** should be selected on the basis of

A	B	C	D
1, 2 and 3 are correct	1 and 2 only are correct	2 and 3 only are correct	1 only is correct

No other combination of statements is used as a correct response.

38 Which compounds will produce a yellow precipitate with alkaline aqueous iodine?

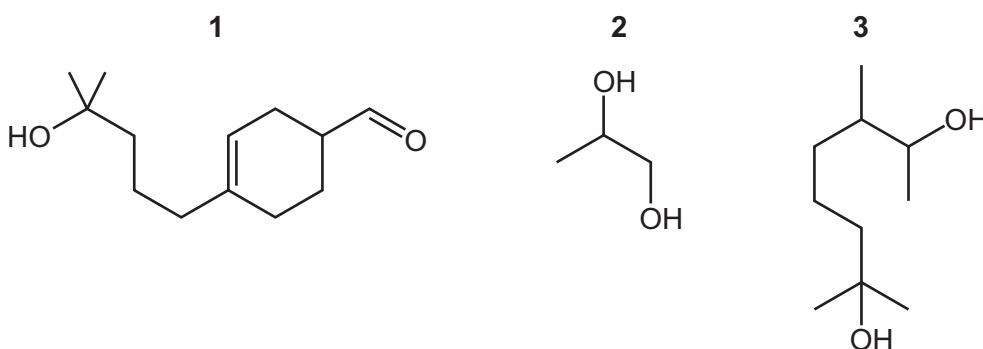

39 Which statements apply to tetrafluoromethane?

- 1 It is rapidly decomposed by ultraviolet radiation.
- 2 It is less harmful to the ozone layer than dichlorodifluoromethane.
- 3 It is a non-polar molecule.

40 Which statements comparing ethene and ethane are correct?

- 1 The bond angles in ethene are larger than the bond angles in ethane.
- 2 Ethene reacts much more quickly with bromine in the dark than ethane does.
- 3 Complete combustion of 0.01 mol of ethene or ethane produces the same volume of gas measured at room temperature and pressure.

BLANK PAGE

BLANK PAGE

Permission to reproduce items where third-party owned material protected by copyright is included has been sought and cleared where possible. Every reasonable effort has been made by the publisher (UCLES) to trace copyright holders, but if any items requiring clearance have unwittingly been included, the publisher will be pleased to make amends at the earliest possible opportunity.

To avoid the issue of disclosure of answer-related information to candidates, all copyright acknowledgements are reproduced online in the Cambridge Assessment International Education Copyright Acknowledgements Booklet. This is produced for each series of examinations and is freely available to download at www.cambridgeinternational.org after the live examination series.

Cambridge Assessment International Education is part of the Cambridge Assessment Group. Cambridge Assessment is the brand name of the University of Cambridge Local Examinations Syndicate (UCLES), which itself is a department of the University of Cambridge.