



UNIVERSITY OF CAMBRIDGE INTERNATIONAL EXAMINATIONS  
General Certificate of Education Ordinary Level

**BIOLOGY**

**5090/12**

Paper 1 Multiple Choice

**October/November 2011**

**1 hour**

Additional Materials:      Multiple Choice Answer Sheet  
   Soft clean eraser  
   Soft pencil (type B or HB is recommended)



**READ THESE INSTRUCTIONS FIRST**

Write in soft pencil.

Do not use staples, paper clips, highlighters, glue or correction fluid.

Write your name, Centre number and candidate number on the Answer Sheet in the spaces provided unless this has been done for you.

There are **forty** questions on this paper. Answer **all** questions. For each question there are four possible answers **A, B, C** and **D**.

Choose the **one** you consider correct and record your choice in **soft pencil** on the separate Answer Sheet.

**Read the instructions on the Answer Sheet very carefully.**

Each correct answer will score one mark. A mark will not be deducted for a wrong answer.  
Any rough working should be done in this booklet.

This document consists of **17** printed pages and **3** blank pages.



- 1 A human cheek cell and a spongy mesophyll cell from a leaf are examined under a microscope.

Which structures are seen in both cells?

- A cell membrane, nucleus and cytoplasm
  - B cell wall, cell membrane and nucleus
  - C cytoplasm, cell wall and cell membrane
  - D nucleus, cytoplasm and cell wall
- 2 Which process needs energy from respiration?
- A movement of carbon dioxide into the alveoli
  - B movement of oxygen into red blood cells
  - C uptake of glucose by cells in the villi
  - D uptake of water by root hair cells
- 3 The mass of a cube of fresh potato is found. It is then placed in a test-tube containing a dilute solution of sucrose. After an hour, its mass has increased.

Which process has occurred and what has happened to the concentration of the sucrose in the solution in the test-tube?

	process	sucrose concentration
<b>A</b>	active transport	decreased
<b>B</b>	active transport	increased
<b>C</b>	osmosis	decreased
<b>D</b>	osmosis	increased

4 The photomicrograph shows a transverse section of a leaf.

Where does carbon dioxide enter the leaf?



5 Two test-tubes, P and Q, were set up each containing a solution of red hydrogen carbonate indicator. Hydrogen carbonate indicator turns yellow when the carbon dioxide concentration increases and turns purple if the carbon dioxide concentration decreases.

An aquatic plant was placed into tubes P and Q. Tube P was uncovered, tube Q was covered with a black lightproof cover. The tubes were left in a warm room in sunlight for four hours.

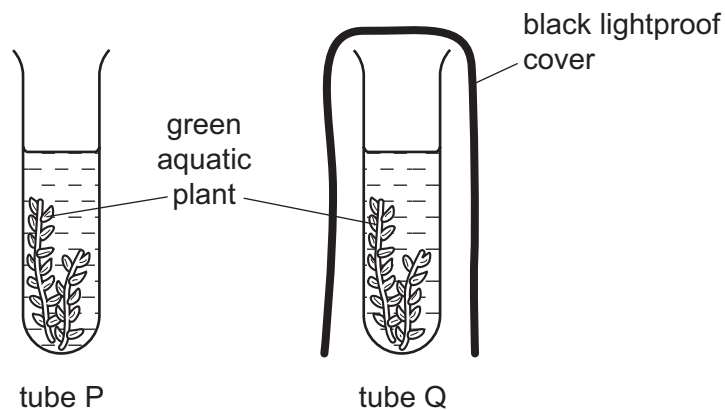

What would be the colour of the hydrogen carbonate indicator in the two tubes after four hours?

	tube P	tube Q
<b>A</b>	purple	red
<b>B</b>	purple	yellow
<b>C</b>	red	yellow
<b>D</b>	yellow	red

6 Which graph shows the effect of temperature on the rate of photosynthesis?

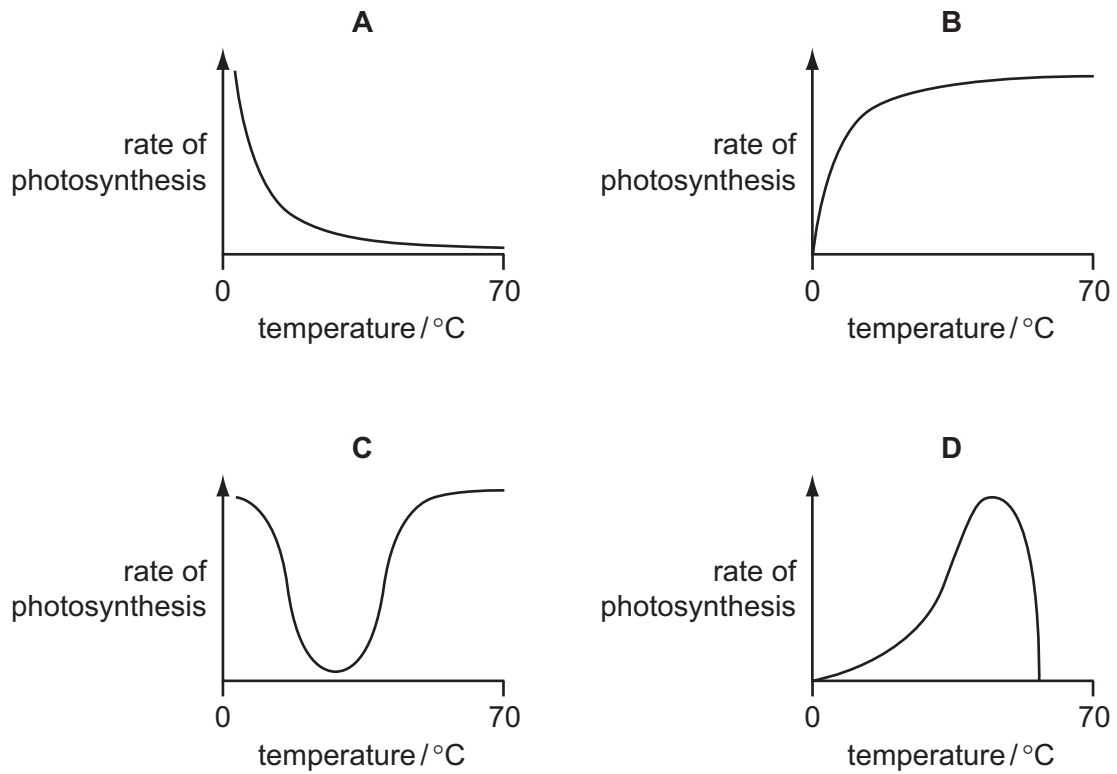

7 The diagram shows part of a transverse section of a leaf.

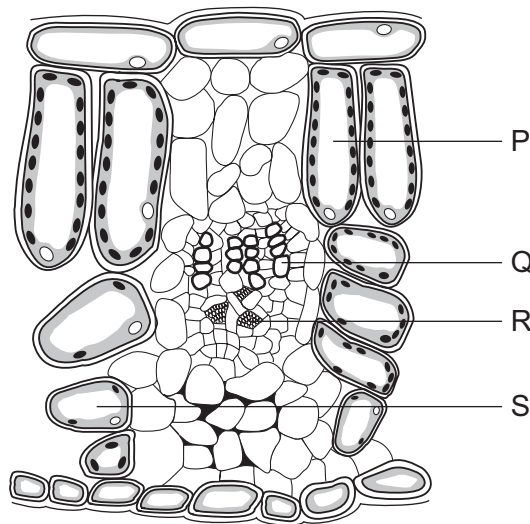

Which cells conduct water into the leaf and which cells conduct sugars out of the leaf?

	conduct water	conduct sugars
<b>A</b>	P	Q
<b>B</b>	Q	P
<b>C</b>	Q	R
<b>D</b>	R	Q

8 The diagram shows a bolus of food moving along the oesophagus.

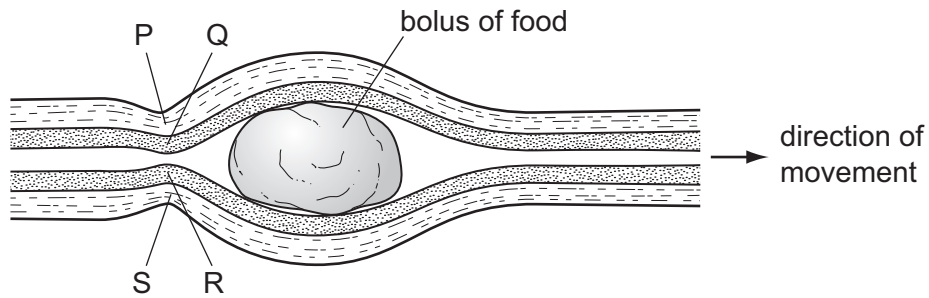

Which row describes the condition of the muscles at P, Q, R and S?

	P	Q	R	S
<b>A</b>	contracted	relaxed	contracted	relaxed
<b>B</b>	contracted	relaxed	relaxed	contracted
<b>C</b>	relaxed	contracted	contracted	relaxed
<b>D</b>	relaxed	contracted	relaxed	contracted

9 The photomicrograph shows human blood.

Which component cannot function effectively if a person's diet lacks iron?

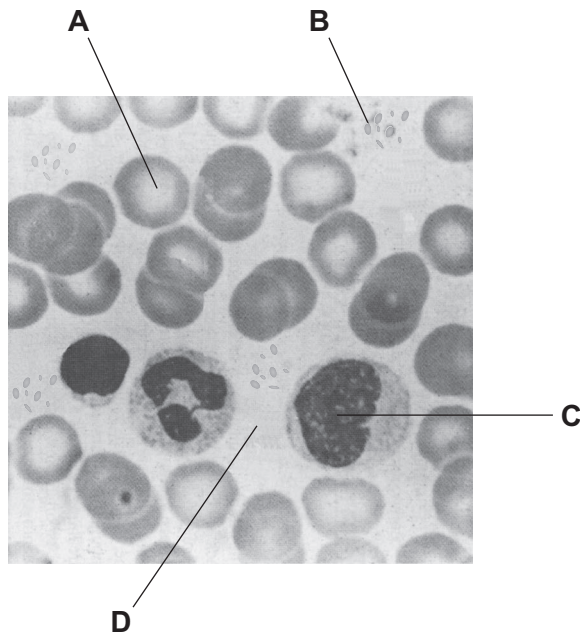

magnification  $\times 1000$

10 Which chemical elements are found in carbohydrates, fats and proteins?

	carbohydrates	fats	proteins
<b>A</b>	carbon, hydrogen and oxygen	carbon, hydrogen and oxygen	carbon, hydrogen, oxygen and nitrogen
<b>B</b>	carbon, hydrogen and oxygen	carbon, hydrogen, oxygen and nitrogen	carbon, hydrogen and oxygen
<b>C</b>	carbon, hydrogen, oxygen and nitrogen	carbon, hydrogen and oxygen	carbon, hydrogen and oxygen
<b>D</b>	carbon, hydrogen, oxygen and nitrogen	carbon, hydrogen and oxygen	carbon, hydrogen, oxygen and nitrogen

11 The diagram shows two plant cells, X and Y, drawn to different scales.

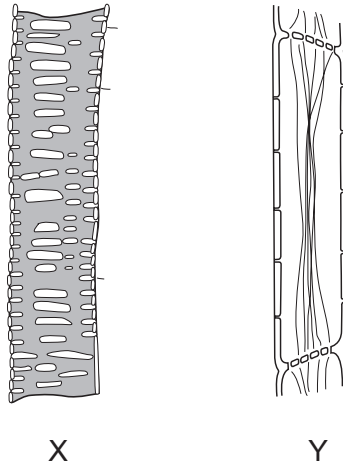

Samples of the contents of X and Y were tested for nutrients.

What results are expected?

	X		Y		
	Benedict's reagent	iodine in potassium iodide solution	Benedict's reagent	iodine in potassium iodide solution	
<b>A</b>	+	+	-	+	key - = negative result + = positive result
<b>B</b>	+	-	+	-	
<b>C</b>	-	+	-	+	
<b>D</b>	-	-	+	-	

12 Which blood vessel carries absorbed food material from the small intestine to the liver?

- A coronary artery
- B hepatic portal vein
- C pulmonary artery
- D renal vein

13 The diagram shows an experiment on amylase.

Each beaker contains water at the temperature shown.

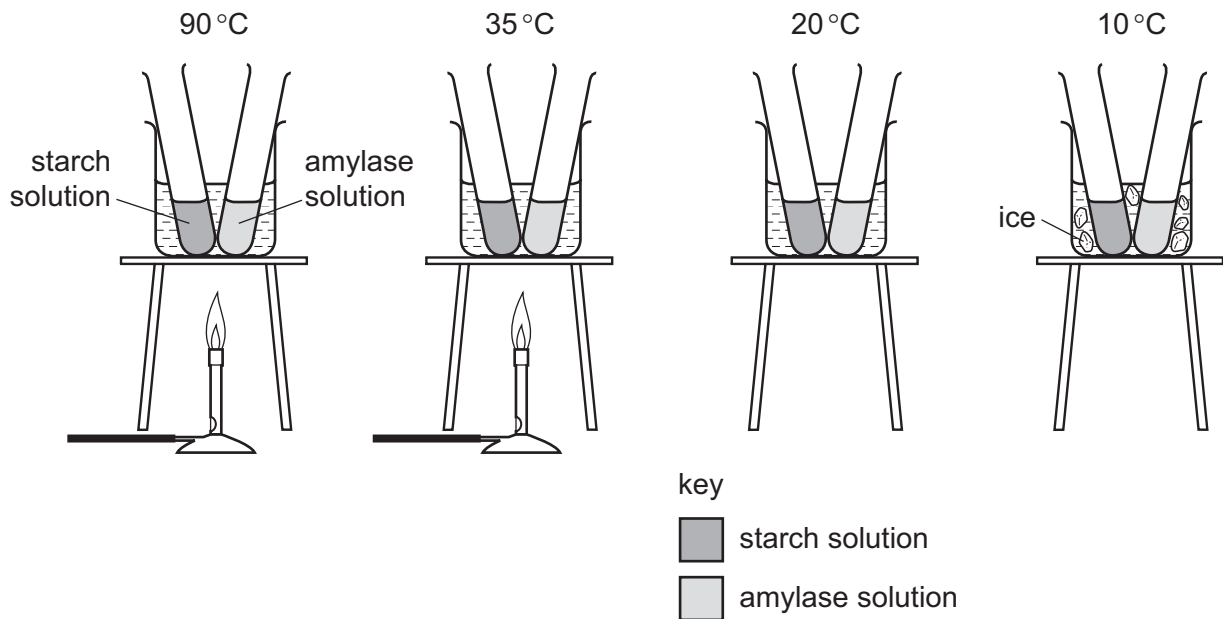

After five minutes, each test-tube of amylase is poured into the test-tube of starch solution in the same beaker.

After leaving the tubes for 5 minutes, samples of the mixture are then tested with iodine solution and then tested again at 5 minute intervals.

Which results are expected?

	90 °C	35 °C	20 °C	10 °C
<b>A</b>	blue-black after 30 minutes	goes yellow-brown immediately	goes yellow-brown after 5 minutes	blue-black after 30 minutes
<b>B</b>	blue-black after 30 minutes	goes yellow-brown after 5 minutes	goes yellow-brown immediately	blue-black after 30 minutes
<b>C</b>	goes yellow-brown immediately	goes yellow-brown after 5 minutes	goes yellow-brown after 5 minutes	blue-black after 30 minutes
<b>D</b>	goes yellow-brown after 5 minutes	blue-black after 30 minutes	blue-black after 30 minutes	goes yellow-brown after 5 minutes

14 What are the products of anaerobic respiration in humans and in yeast?

	humans	yeast
<b>A</b>	ethanol	lactic acid
<b>B</b>	ethanol and carbon dioxide	lactic acid and carbon dioxide
<b>C</b>	lactic acid	ethanol and carbon dioxide
<b>D</b>	lactic acid and carbon dioxide	ethanol

15 The diagram shows the ribs and some of the muscles used in breathing.

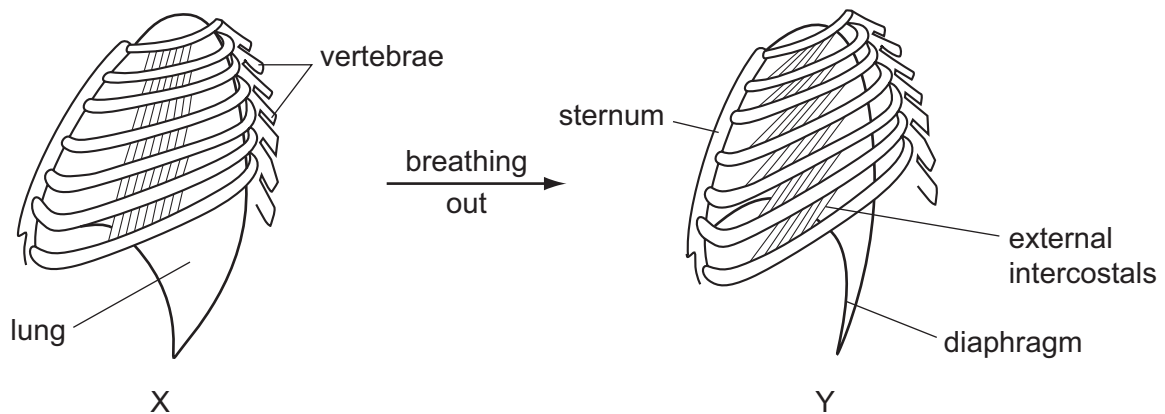

Which muscles relax in moving from position X to position Y?

	diaphragm	external intercostals
<b>A</b>	no	no
<b>B</b>	no	yes
<b>C</b>	yes	no
<b>D</b>	yes	yes



16 The diagram shows a section through part of a blood vessel.

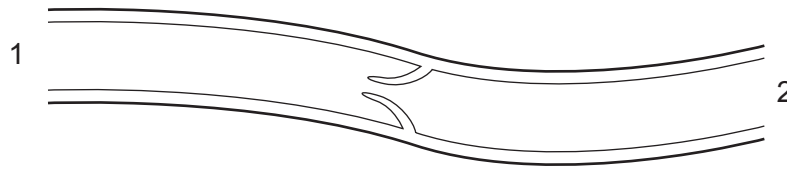

What could be the first organs found in the directions 1 and 2?

	1	2
<b>A</b>	heart	brain
<b>B</b>	intestine	liver
<b>C</b>	kidney	heart
<b>D</b>	lung	heart

17 The diagram represents the heart and some major blood vessels.

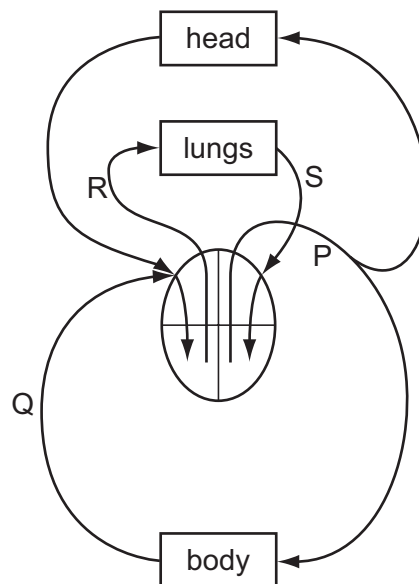

Which are possible blood pressures (in kPa) for the vessels shown on the diagram?

	P	Q	R	S
<b>A</b>	1	4	2	16
<b>B</b>	4	16	2	1
<b>C</b>	16	2	4	1
<b>D</b>	16	4	1	2

18 The diagram represents a kidney dialysis machine.

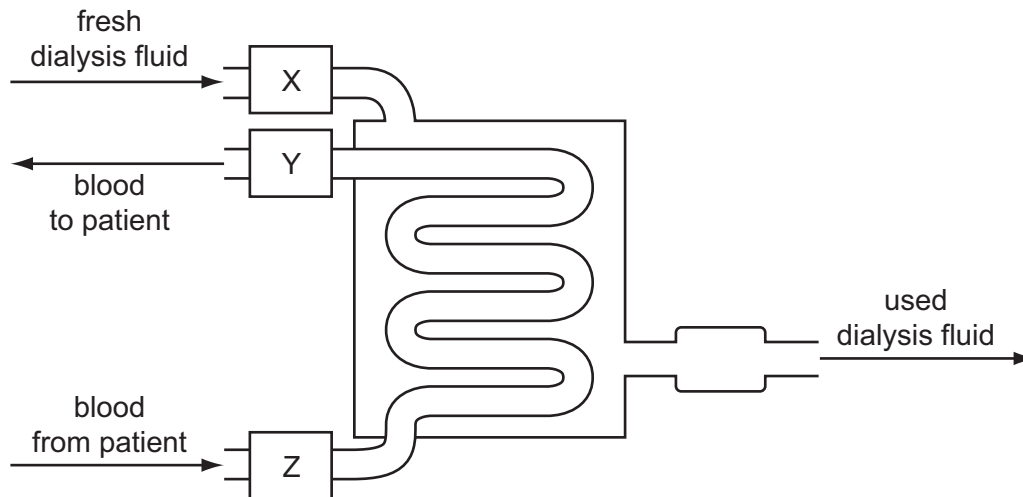

What are the parts labelled X, Y and Z?

	bubble trap	roller pump	water bath for temperature control
<b>A</b>	X	Y	Z
<b>B</b>	Y	X	Z
<b>C</b>	Y	Z	X
<b>D</b>	Z	Y	X

19 What helps heat retention in the human body?

- A** actively secreting sweat glands
- B** dilated skin blood vessels
- C** fat in and under the skin
- D** relaxed hair erector muscles

20 The table shows the composition of inspired and expired air.

	inspired air %	expired air %
carbon dioxide	0.04	X
oxygen	20	16
nitrogen and inert gases	79.96	Y

What are the likely percentages at X and Y?

	X	Y
<b>A</b>	0.04	83.96
<b>B</b>	4.04	79.96
<b>C</b>	20.04	63.96
<b>D</b>	83.96	0.04

21 The diagram shows the bones of the forelimb.

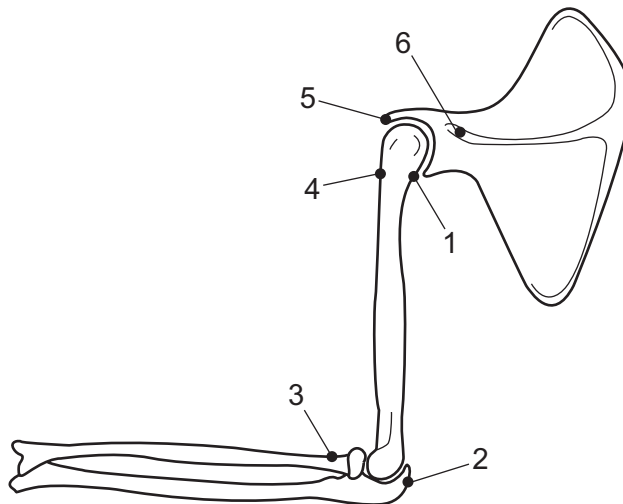

Which labels show where the muscle that straightens the hinge joint is attached?

- A** 1 and 2      **B** 3 and 4      **C** 4 and 5      **D** 4 and 6

22 Foods can be made by treating milk in different ways.

- 1 Bacteria are added.
- 2 The milk is acidified.
- 3 The milk proteins are coagulated.

Which processes occur in both cheese and yoghurt production?

- A** 1, 2 and 3      **B** 1 and 2 only      **C** 1 and 3 only      **D** 2 and 3 only

- 23 Two containers, X and Y, were filled with equal amounts of dough mixture for making bread. The mixture in Y had yeast in it.

The containers were then left in a warm place for two hours. The diagram shows their appearance after this time.

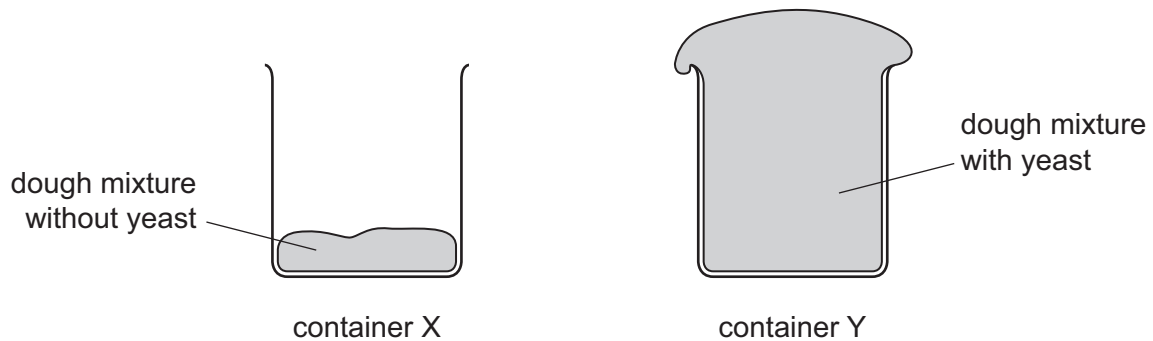

Which substance produced by the yeast causes the difference between containers X and Y?

- A alcohol
  - B carbon dioxide
  - C lactic acid
  - D oxygen
- 24 Why is a *producer* so called?
- A It produces carbohydrates.
  - B It produces carbon dioxide.
  - C It produces energy.
  - D It produces oxygen.

25 The diagram shows a section through the eye.

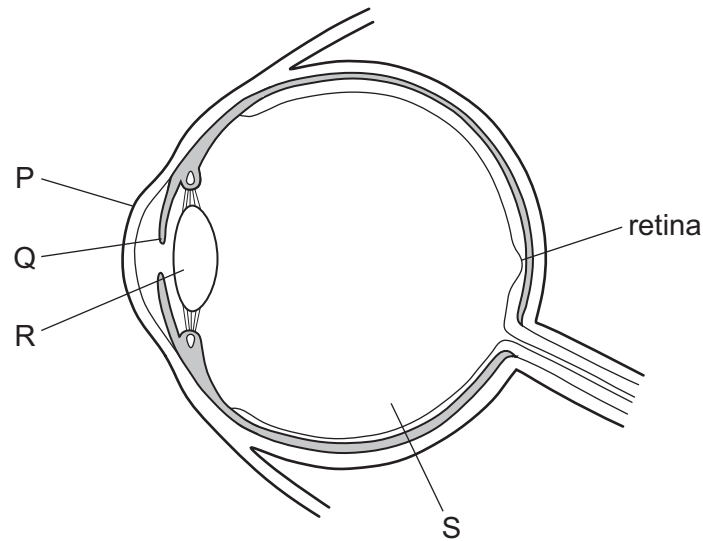

Which pair of structures focus light rays onto the retina?

- A** P and Q      **B** P and R      **C** Q and R      **D** Q and S
- 26 Which part of the central nervous system controls the body's water balance?
- A** cerebellum  
**B** cerebrum  
**C** hypothalamus  
**D** medulla
- 27 How does adrenaline affect glucose uptake by muscle cells and carbohydrate conversion by liver cells?

	glucose uptake	carbohydrate conversion
<b>A</b>	decreases	glucose to glycogen
<b>B</b>	decreases	glycogen to glucose
<b>C</b>	increases	glucose to glycogen
<b>D</b>	increases	glycogen to glucose

- 28 What is a major effect of nicotine in tobacco smoke?
- A** It causes lung cancer.  
**B** It destroys cilia in the trachea.  
**C** It increases mucus production in the trachea.  
**D** It increases the desire to smoke.

29 The diagram shows four ecological pyramids.

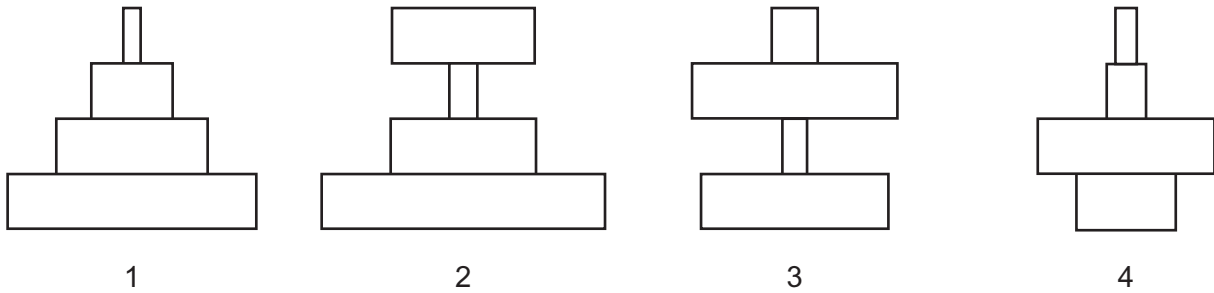

In a food chain, grass is eaten by cows. The cows have insects living on their skin. The insects are eaten by birds.

Which is the pyramid of mass and which is the pyramid of numbers in this food chain?

	pyramid of mass	pyramid of numbers
<b>A</b>	1	3
<b>B</b>	1	4
<b>C</b>	3	1
<b>D</b>	3	2

30 Which row shows a disease and the organism that causes it?

	disease	organism that causes it
<b>A</b>	AIDS	bacterium
<b>B</b>	AIDS	insect
<b>C</b>	malaria	insect
<b>D</b>	syphilis	bacterium

31 What is **not** a result of changing the size of the holes in fishing nets?

	smaller holes	larger holes
<b>A</b>	bigger fish are caught	small fish pass through the net
<b>B</b>	many fish reproduce before they are caught	most fish do not reproduce
<b>C</b>	more fish are caught	fewer fish are caught
<b>D</b>	smaller fish are caught	larger fish are caught

32 The diagram shows organisms in a habitat.

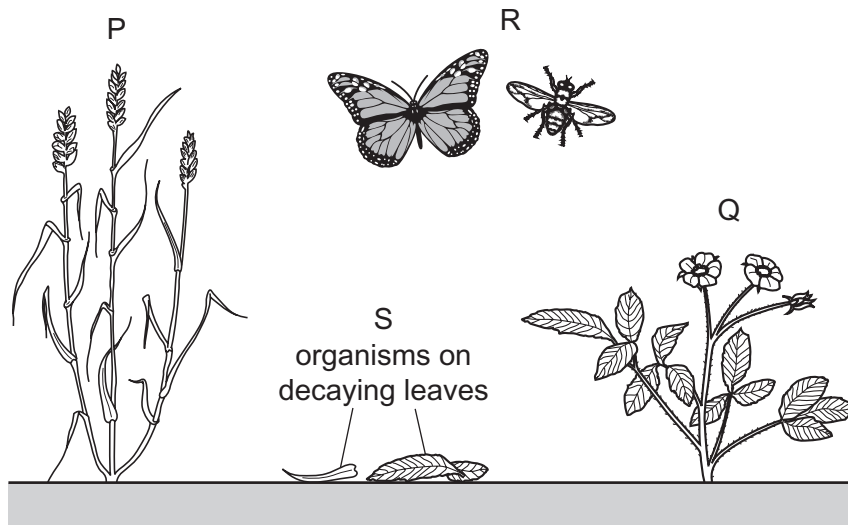

Which shows the feeding relationships of these organisms?

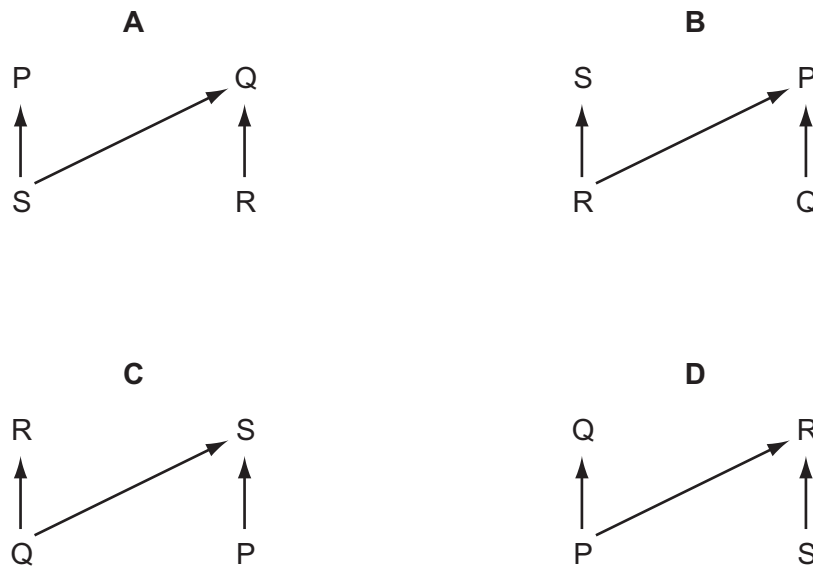

33 Which conditions are necessary to activate enzymes when a seed germinates?

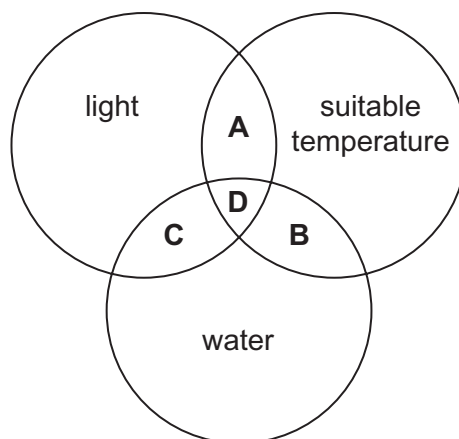

34 A recessive homozygote is crossed with a heterozygote of the same gene.

What will be the phenotypes of the F<sub>1</sub> generation?

- A all dominant
- B 75% dominant      25% recessive
- C 50% dominant      50% recessive
- D 25% dominant      50% heterozygous      25% recessive

35 A child has blood group O.

Which couple could be the parents of this child?

	blood group of father	blood group of mother
A	A	B
B	AB	B
C	O	AB
D	AB	A

36 Which process is used to produce insulin commercially?

- A extracting glycogen from the liver to stimulate production of insulin
- B extracting insulin from the pancreas of human volunteers
- C inserting a bacterial gene into a person's pancreas cells
- D inserting the human insulin gene into a bacterium



- 37 New plants may be grown from groups of cells that are taken from other plants.

The diagram shows part of plant X.

From which structure will cell samples grow into new plants that are genetically identical to plant X?

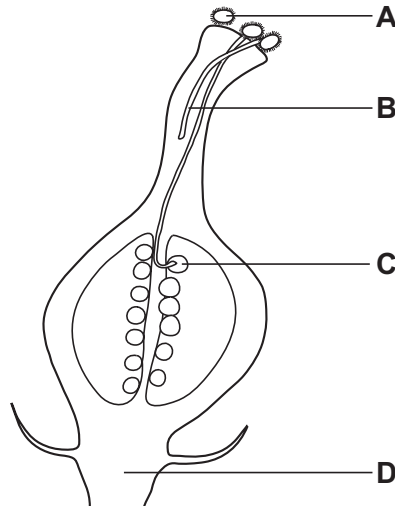

- 38 What is a major advantage of feeding breast milk rather than milk made up from milk powder to a baby?
- A It contains a higher percentage of calcium for growth of the baby's bones.
  - B It contains all the carbohydrates, proteins and vitamins needed by the baby.
  - C It contains antibodies from the mother, which protect the baby from infectious diseases.
  - D It contains less protein, sugar and fat, which prevent the baby from becoming obese.
- 39 On which date is a woman most likely to ovulate if the first day of menstrual loss was 1 February?
- A 5 February
  - B 14 February
  - C 28 February
  - D 1 March
- 40 Two heterozygotes are crossed. Some of the offspring show the recessive characteristic.
- What is the probability that one of these offspring that shows the recessive characteristic is homozygous?
- A 0.00
  - B 0.25
  - C 0.50
  - D 1.00

**BLANK PAGE**

**BLANK PAGE**

**BLANK PAGE**

---

Permission to reproduce items where third-party owned material protected by copyright is included has been sought and cleared where possible. Every reasonable effort has been made by the publisher (UCLES) to trace copyright holders, but if any items requiring clearance have unwittingly been included, the publisher will be pleased to make amends at the earliest possible opportunity.

University of Cambridge International Examinations is part of the Cambridge Assessment Group. Cambridge Assessment is the brand name of University of Cambridge Local Examinations Syndicate (UCLES), which is itself a department of the University of Cambridge.