



UNIVERSITY OF CAMBRIDGE INTERNATIONAL EXAMINATIONS
General Certificate of Education Ordinary Level

PHYSICS

5054/11

Paper 1 Multiple Choice

October/November 2013

1 hour

Additional Materials: Multiple Choice Answer Sheet
 Soft clean eraser
 Soft pencil (type B or HB is recommended)

* 2 6 3 5 7 7 1 4 9 8 *

READ THESE INSTRUCTIONS FIRST

Write in soft pencil.

Do not use staples, paper clips, highlighters, glue or correction fluid.

Write your name, Centre number and candidate number on the Answer Sheet in the spaces provided unless this has been done for you.

DO NOT WRITE IN ANY BARCODES.

There are **forty** questions on this paper. Answer **all** questions. For each question there are four possible answers **A, B, C** and **D**.

Choose the **one** you consider correct and record your choice in **soft pencil** on the separate Answer Sheet.

Read the instructions on the Answer Sheet very carefully.

Each correct answer will score one mark. A mark will not be deducted for a wrong answer.

Any rough working should be done in this booklet.

Electronic calculators may be used.

This document consists of **19** printed pages and **1** blank page.



1 When there is no wind, the engines of an airship push it due north at 20 m/s.

The wind is blowing from the west at 12 m/s.

Which vector diagram correctly shows how the resultant velocity R of the airship is obtained?

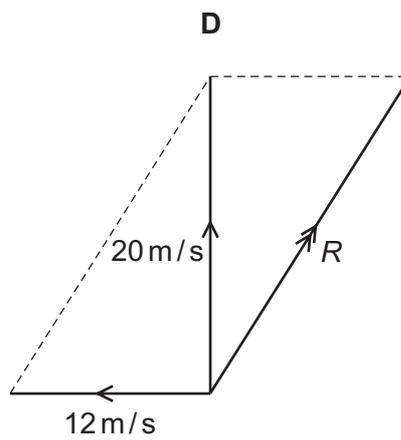
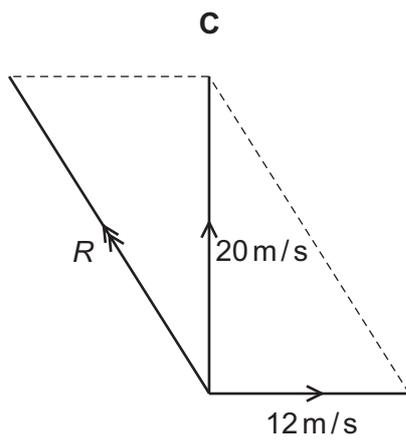
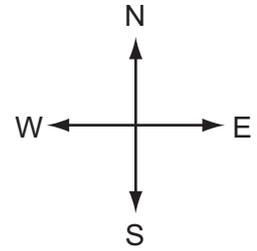
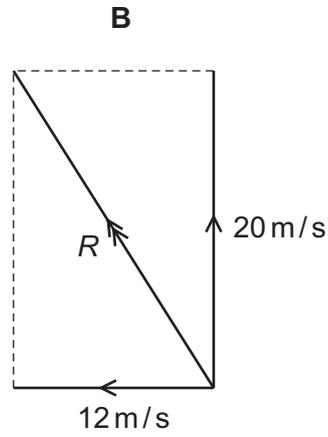
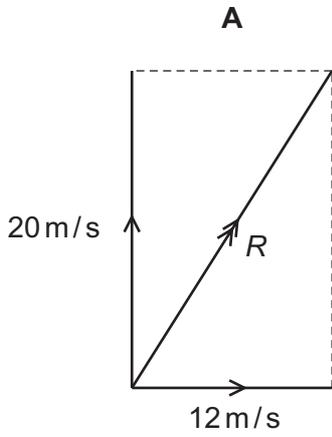

- 2 A length of copper pipe, of uniform cross-section and several metres long, carries water to a tap.

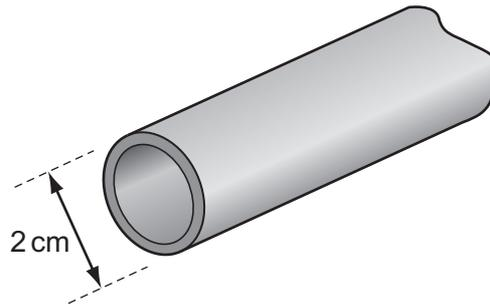

Measurements are taken to determine accurately the volume of copper in the pipe.

Which instruments are used?

- A calipers and micrometer
 - B micrometer and rule
 - C rule and tape
 - D tape and calipers
- 3 An object moves from P to Q in 10 s with uniform acceleration.

velocity at P = 5 m/s

velocity at Q = 12 m/s

What is the acceleration?

- A 0.5 m/s^2
 - B 0.7 m/s^2
 - C 1.2 m/s^2
 - D 1.7 m/s^2
- 4 A student kicks a ball horizontally along the ground. As he does so, his foot applies a force to the ball.
- At the same time, the ball applies a force to his foot.
- How do these forces compare?
- A The force on the foot is equal to the force on the ball and in the opposite direction.
 - B The force on the foot is equal to the force on the ball and in the same direction.
 - C The force on the foot is smaller than the force on the ball and in the opposite direction.
 - D The force on the foot is smaller than the force on the ball and in the same direction.

- 5 The diagram shows an aeroplane turning in a horizontal circle at constant speed.

In which direction is there a resultant force?

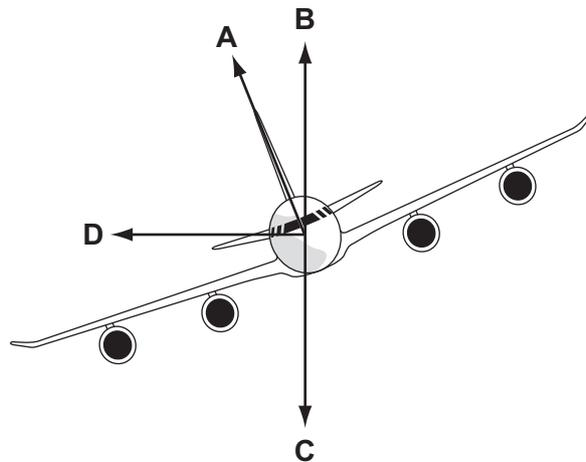

- 6 A spacecraft travels from the Earth to the Moon.

At a certain point in the journey, it has zero weight.

Why is the weight zero at this point?

- A The gravitational fields of the Earth and the Moon cancel each other.
 - B The spacecraft leaves the Earth's gravitational field.
 - C The spacecraft stops moving.
 - D There is no air resistance on the spacecraft.
- 7 A piece of uniform card is suspended freely from a horizontal pin.

Which point is its centre of mass?

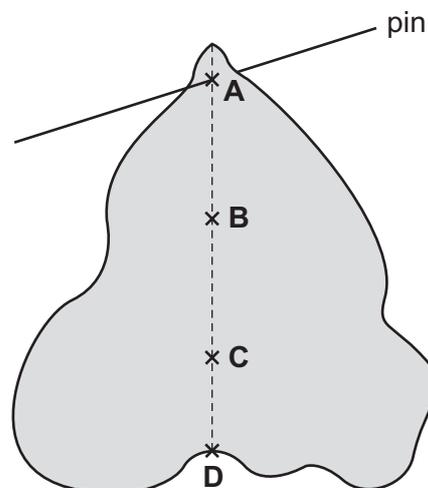

- 8 An extension-load graph is plotted to show the result of increasing the load on a spring.

Which point marks the limit of proportionality for this spring?

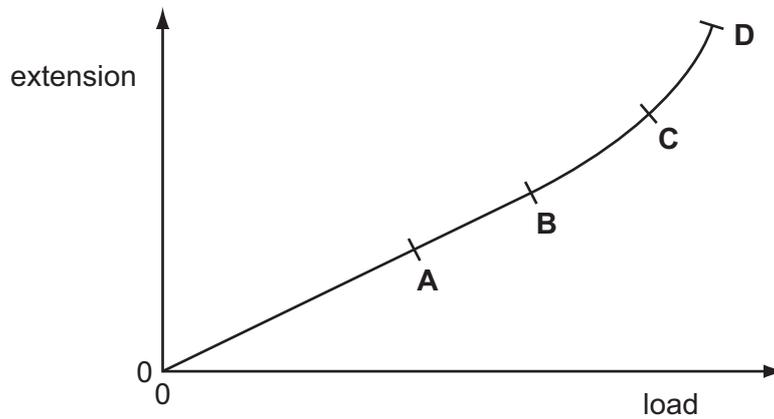

- 9 Four different liquids are poured into identical measuring cylinders. The diagrams show the depths of the liquids and their densities.

Which liquid causes the largest pressure on the base of its measuring cylinder?

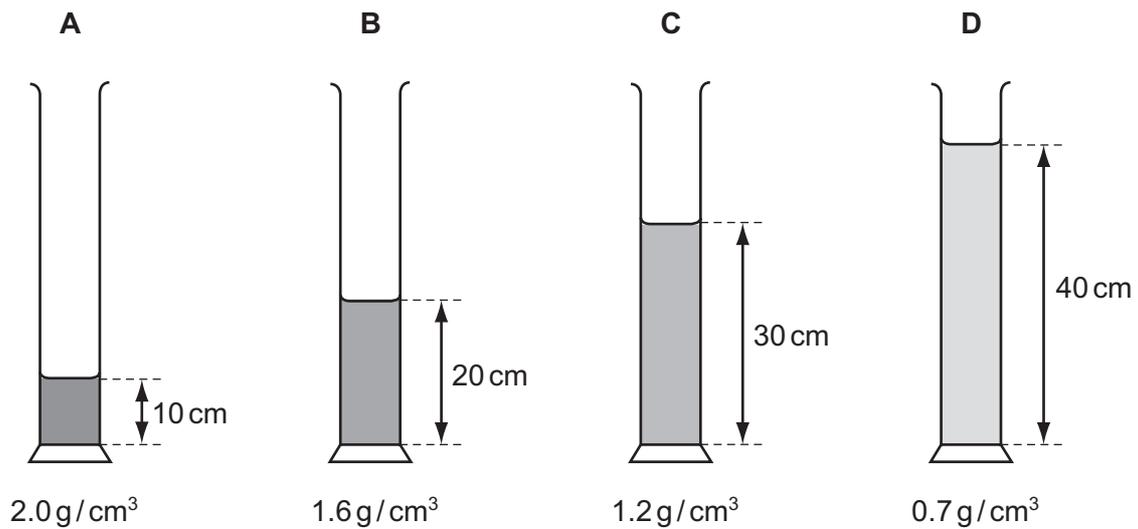

10 A manometer is attached to a gas cylinder as shown.

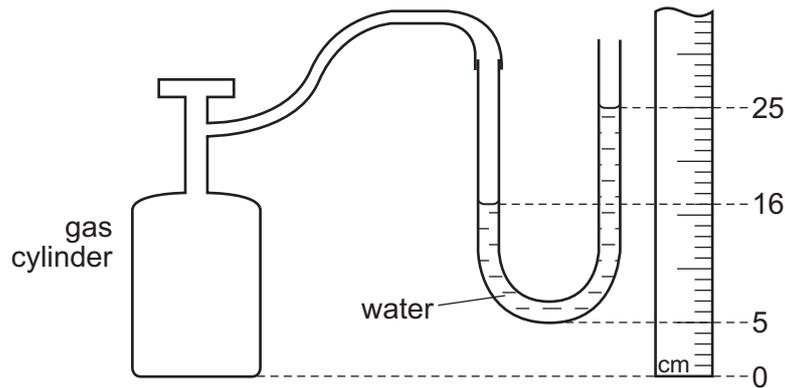

What is the pressure difference, in cm of water, shown by the manometer?

- A** 9 **B** 16 **C** 20 **D** 25

11 Three objects P, Q and R have different masses and different speeds as shown in the table.

	$\frac{\text{mass}}{\text{kg}}$	$\frac{\text{speed}}{\text{m/s}}$
P	1	3
Q	2	2
R	5	1

What is the order of increasing kinetic energy (smallest first) of the objects?

- A** P → Q → R
B P → R → Q
C R → P → Q
D R → Q → P

12 Which energy resource comes from hot rocks beneath the Earth's surface?

- A** geothermal energy
B hydroelectric energy
C solar energy
D wind energy

- 13 On a cold afternoon, a house loses 54 MJ of thermal energy (heat) to its surroundings as shown.

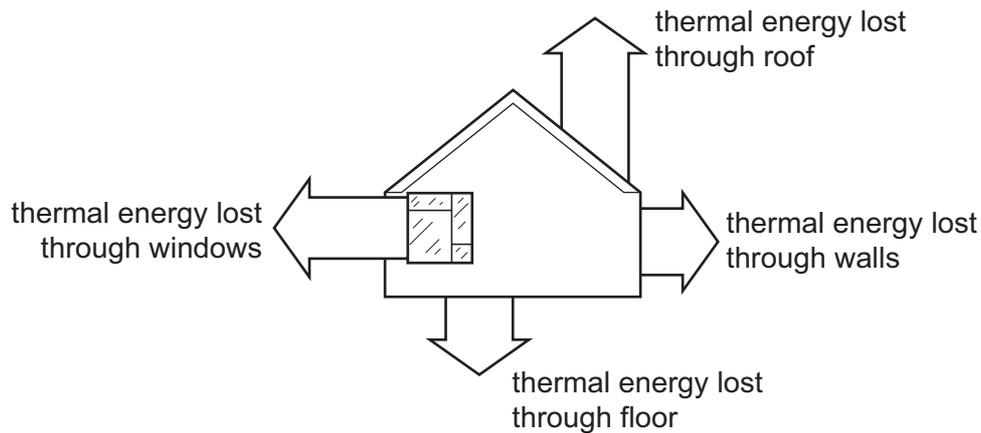

The heating system must supply more than 54 MJ of thermal energy to keep the temperature of the house constant.

Which statement explains this?

- A The extra thermal energy is lost from the house to the surroundings by other means.
 - B The extra thermal energy keeps the house warmer than the surroundings.
 - C The temperature of the surroundings decreases continuously during this period.
 - D The thermal insulation of the roof is extremely ineffective.
- 14 The temperature shown by a mercury-in-glass thermometer increases.

Which of the following is constant?

- A the density of the mercury
- B the internal energy of the mercury
- C the mass of the mercury
- D the volume of the mercury

15 The diagram shows a clinical thermometer.

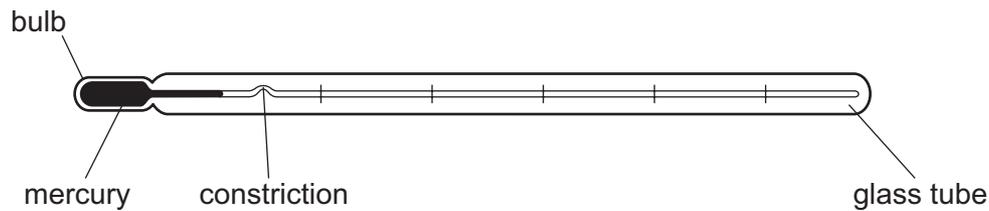

Which factor affects the sensitivity of the thermometer?

- A the constriction
- B the length of the glass tube
- C the thickness of the glass in the wall of the bulb
- D the volume of mercury in the thermometer

16 The length of mercury in the bore of a thermometer is 5.0 cm at 0°C and 11.0 cm at 60°C.

What is the length in the bore when the temperature is -10°C ?

- A 1.0 cm
 - B 4.0 cm
 - C 6.0 cm
 - D 10.0 cm
- 17 When a person climbs out of a warm swimming pool on a hot summer day, he feels cold.
- Why does this happen?
- A The air has a high specific heat capacity.
 - B The air is a better conductor of heat than water.
 - C The water droplets increase his surface area.
 - D The water takes heat from his body to evaporate.

18 Which row correctly describes the shape and volume of a gas?

	shape	volume
A	fixed	fixed
B	fixed	not fixed
C	not fixed	fixed
D	not fixed	not fixed

19 The diagram shows a ball floating in a tank of water.

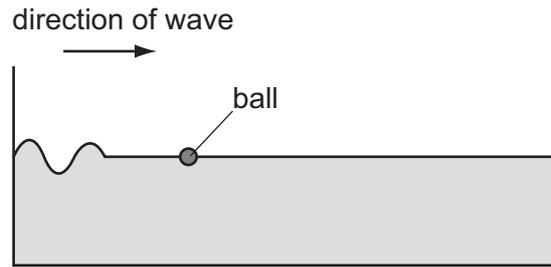

Which diagram shows the movement of the ball as the wave passes?

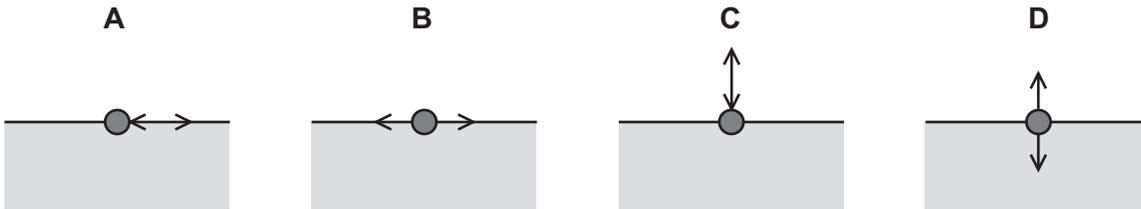

20 Which diagram represents the reflection of light along an optical fibre?

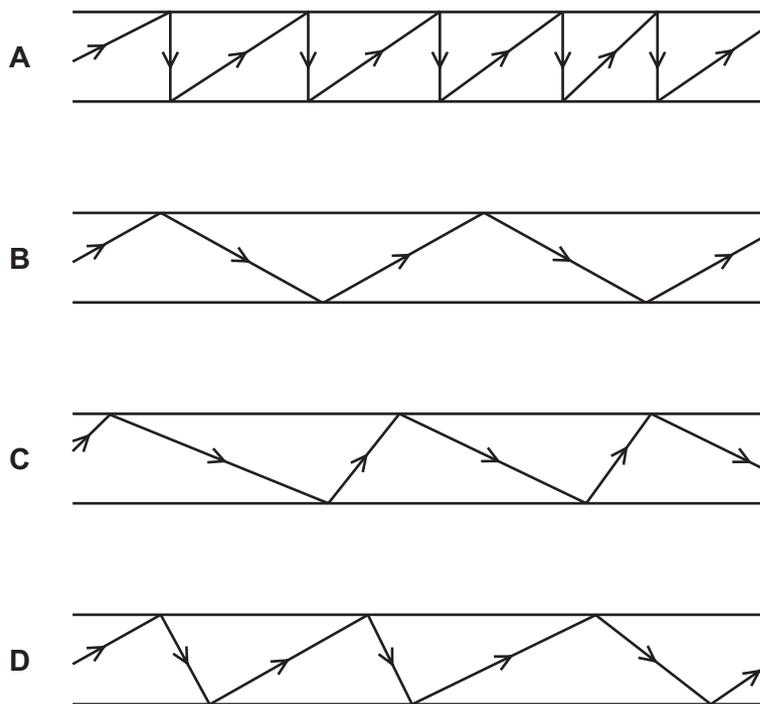

21 The diagram shows rays of light.

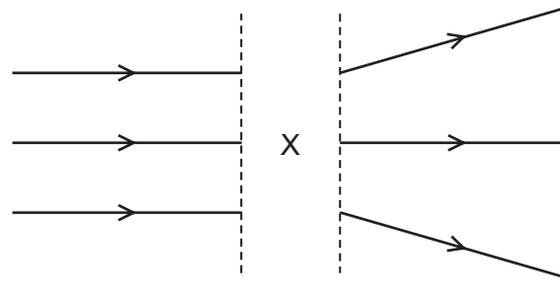

What is in the space labelled X?

- A a converging lens
 - B a diverging lens
 - C a plane mirror
 - D a rectangular glass block
- 22 The table lists the main components of the electromagnetic spectrum and their approximate frequency range.

	frequency / Hz
gamma rays	10^{22} to 10^{19}
X-rays	10^{21} to 10^{18}
ultra-violet	10^{18} to 10^{15}
visible light	10^{15} to 10^{14}
infra-red	10^{14} to 10^{12}
microwaves	10^{12} to 10^9
radiowaves	10^9 to 10^3

Which range of frequencies can be used to detect cracks inside a block of metal?

- A 10^3 Hz to 10^{12} Hz
- B 10^{12} Hz to 10^{15} Hz
- C 10^{15} Hz to 10^{18} Hz
- D 10^{18} Hz to 10^{22} Hz

23 The graph shows how the pressure varies as a sound wave passes through air.

Which point represents a compression?

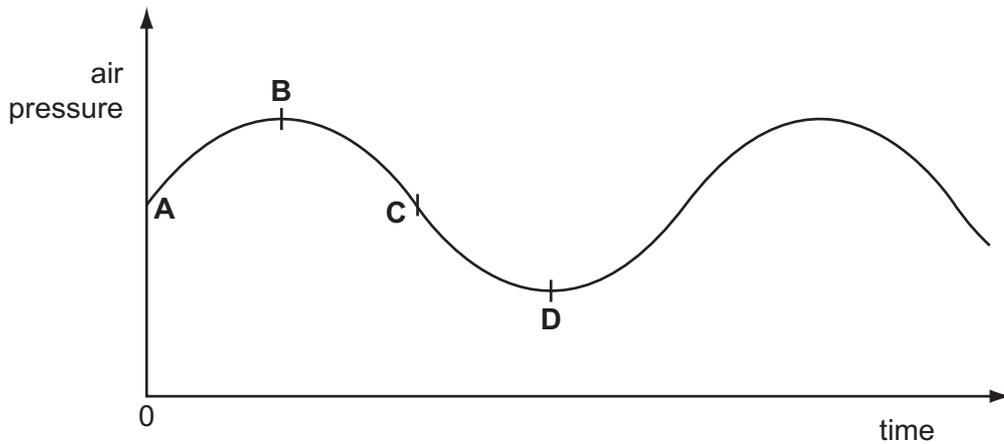

24 The sounds produced by two musical instruments are directed towards a microphone connected to an oscilloscope (c.r.o.). The waveforms produced on the screen are shown.

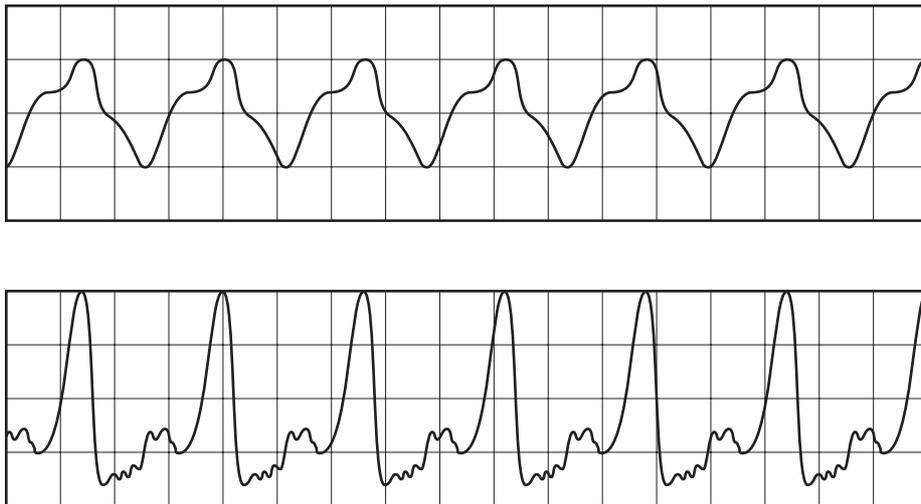

The waveforms show that the sounds produced have a different property.

What is the property?

- A frequency
- B speed
- C timbre (quality)
- D wavelength

25 The diagram shows the shape of the magnetic field lines near a current-carrying conductor.

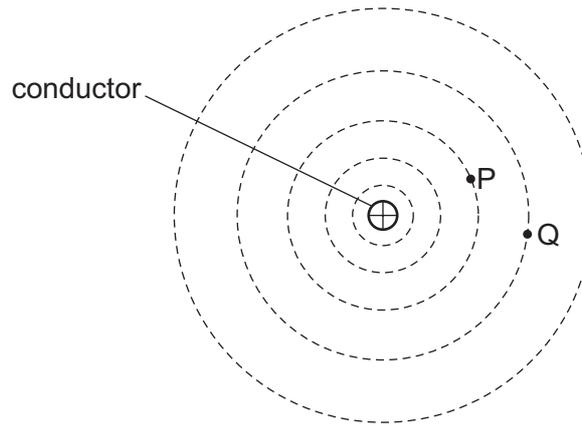

The current in the conductor is into the plane of the diagram.

Which row correctly states the direction of the field lines and compares the strengths of the field at points P and Q?

	direction of field lines	the field is stronger at
A	clockwise	P
B	clockwise	Q
C	anticlockwise	P
D	anticlockwise	Q

26 Two charged conducting spheres are placed close to one another.

One sphere is positively charged and the other is negatively charged.

Which diagram shows the distribution of charges and the forces acting on the spheres?

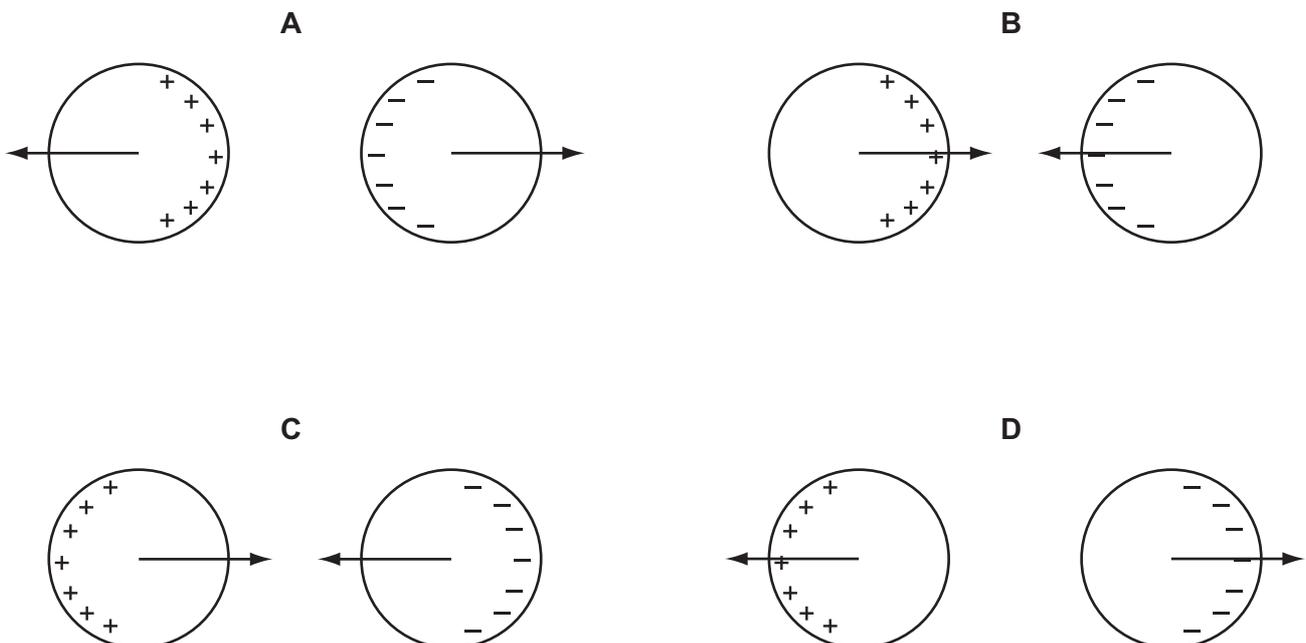

27 Which row shows a conductor and an insulator?

	conductor	insulator
A	aluminium	copper
B	aluminium	glass
C	plastic	copper
D	plastic	glass

28 Which of the following is equivalent to one coulomb?

- A** one ampere second
- B** one ampere per volt
- C** one volt ampere
- D** one volt per ampere

29 The diagram shows a circuit in which all the switches are open.

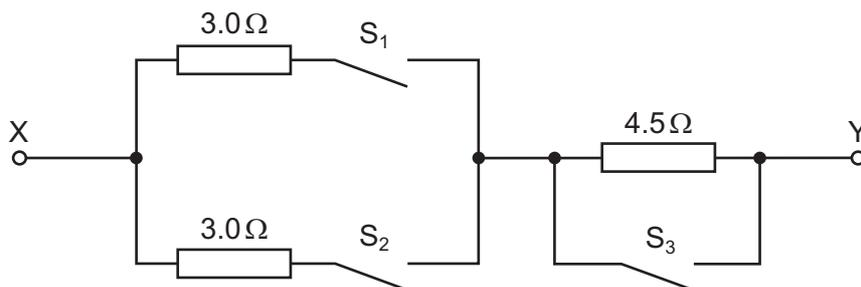

Which switch positions give a resistance of $6.0\ \Omega$ between X and Y?

	S_1	S_2	S_3
A	closed	closed	closed
B	closed	closed	open
C	closed	open	closed
D	closed	open	open

30 The circuit shows three resistors connected to a cell.

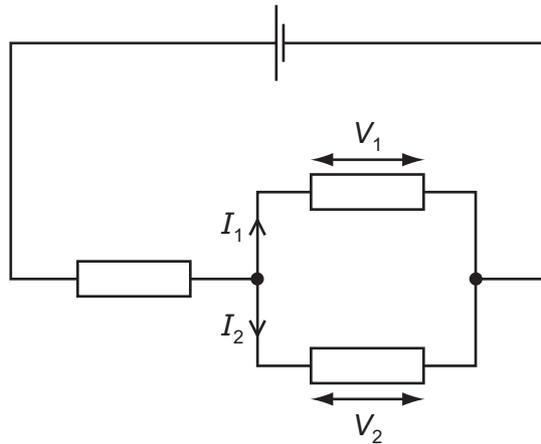

The resistors have different values of resistance.

V_1 and V_2 are potential differences and I_1 and I_2 are currents as shown.

Which pair of relationships is correct?

- A $I_1 = I_2$ and $V_1 = V_2$
- B $I_1 = I_2$ and $V_1 \neq V_2$
- C $I_1 \neq I_2$ and $V_1 = V_2$
- D $I_1 \neq I_2$ and $V_1 \neq V_2$

31 A transformer is used to operate a 12 V lamp from a 250 V mains supply.

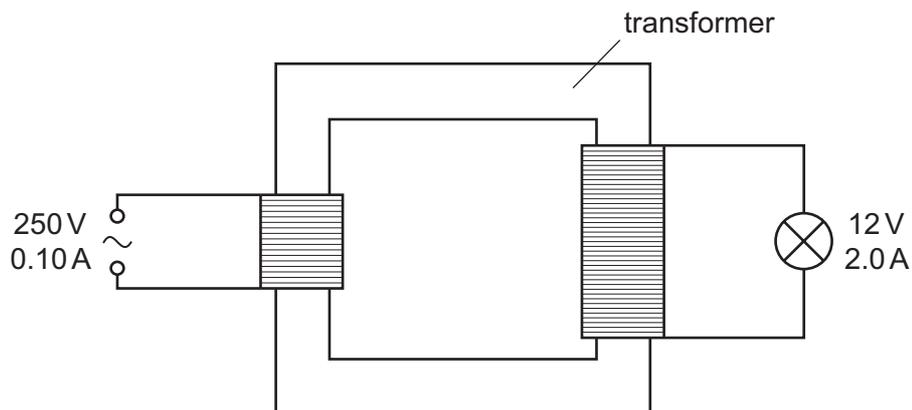

The mains current is 0.10 A. The current in the lamp is 2.0 A.

What is the efficiency of the transformer?

- A 0.048
- B 0.050
- C 0.96
- D 1.04

32 A current-carrying wire lies between the poles of two magnets, as shown.

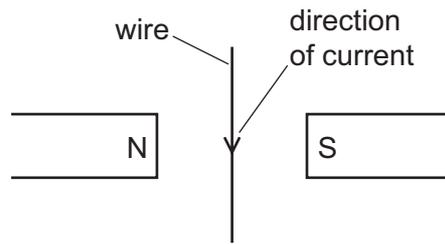

What is the direction of the force on the wire?

- A into the plane of the paper
- B out of the plane of the paper
- C towards the N-pole
- D towards the S-pole

- 33 The graph shows the output of an a.c. generator. The coil in the generator rotates 20 times in one second.

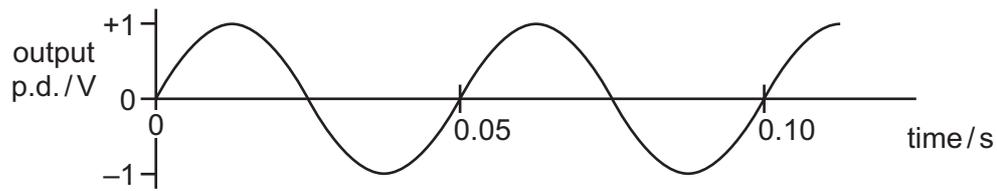

The speed of rotation of the coil steadily increases.

Which graph best shows how the output changes?

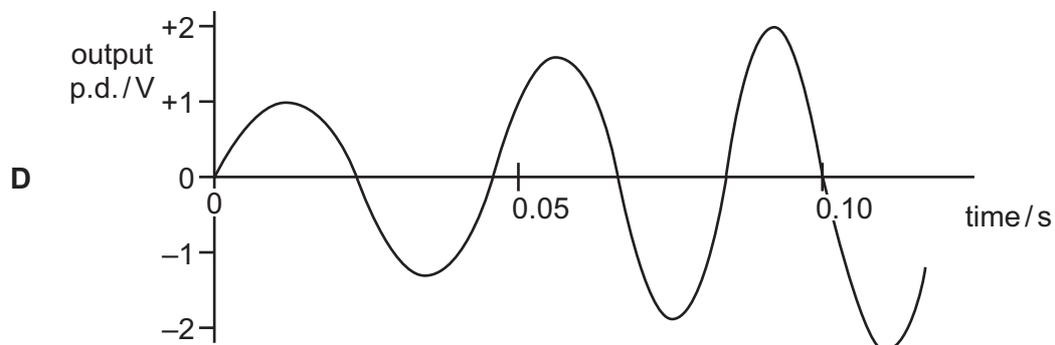
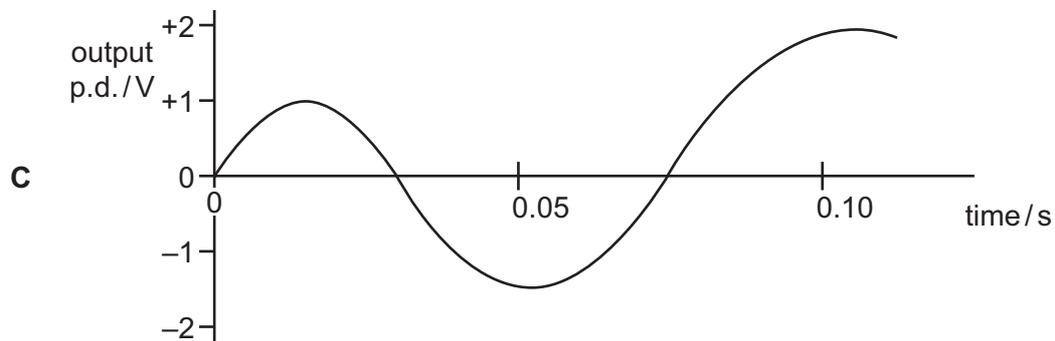
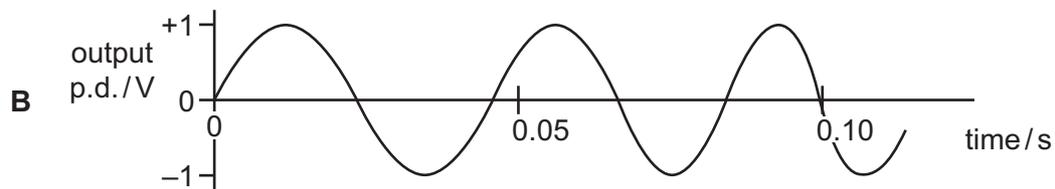
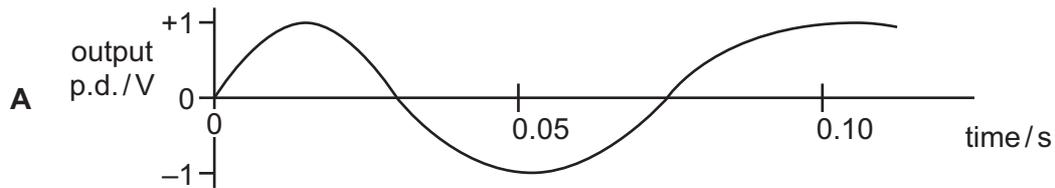

34 Which material is used for the core of a transformer and why?

	material	reason
A	copper	good conductor of electricity
B	copper	easy to magnetise and demagnetise
C	iron	good conductor of electricity
D	iron	easy to magnetise and demagnetise

35 Which particles are emitted in the process of thermionic emission?

- A** electrons
- B** ions
- C** neutrons
- D** protons

36 A thermistor and a light-dependent resistor are connected in series.

Which conditions give the largest resistance?

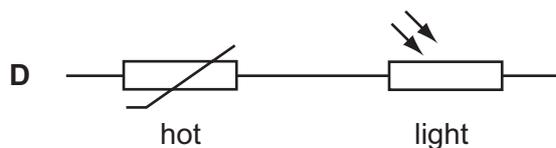
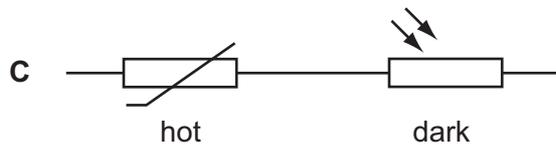
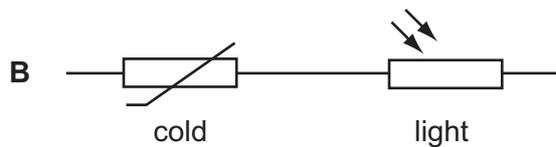
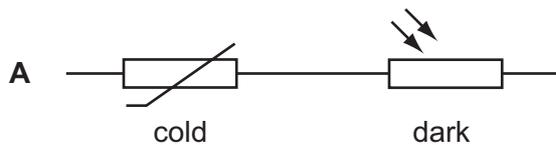

37 What are the characteristics of an alpha-particle?

	charge	ionising effect
A	negative	strong
B	negative	weak
C	positive	strong
D	positive	weak

38 Alpha-particles pass through an electric field or a magnetic field.

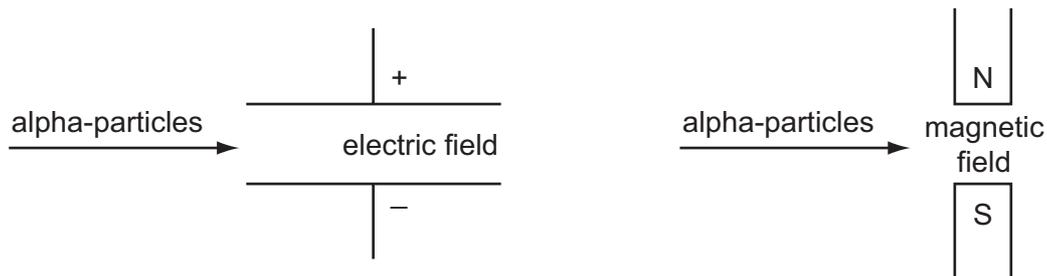

How is the path of the particles affected by these fields?

	electric field	magnetic field
A	deflected	deflected
B	deflected	undeflected
C	undeflected	deflected
D	undeflected	undeflected

39 Which row is correct for nuclear fission and for nuclear fusion?

	fission	fusion
A	produces larger nuclei	is the energy source of a star
B	produces larger nuclei	releases energy in a power station
C	produces smaller nuclei	is the energy source of a star
D	produces smaller nuclei	releases energy in a power station

40 The compositions of four nuclei are shown in the table.

nucleus	number of protons	number of neutrons	number of nucleons
P	88	141	229
Q	88	136	224
R	89	139	228
S	92	136	228

Which two nuclei are isotopes of the same element?

- A** P and Q **B** P and S **C** Q and S **D** R and S

BLANK PAGE

Permission to reproduce items where third-party owned material protected by copyright is included has been sought and cleared where possible. Every reasonable effort has been made by the publisher (UCLES) to trace copyright holders, but if any items requiring clearance have unwittingly been included, the publisher will be pleased to make amends at the earliest possible opportunity.

Cambridge International Examinations is part of the Cambridge Assessment Group. Cambridge Assessment is the brand name of University of Cambridge Local Examinations Syndicate (UCLES), which is itself a department of the University of Cambridge.