

UNIVERSITY OF CAMBRIDGE INTERNATIONAL EXAMINATIONS
General Certificate of Education Ordinary Level

PHYSICS

5054/01

Paper 1 Multiple Choice

May/June 2004

1 hour

Additional Materials: Multiple Choice Answer Sheet
Soft clean eraser
Soft pencil (type B or HB is recommended)

READ THESE INSTRUCTIONS FIRST

Write in soft pencil.

Do not use staples, paper clips, highlighters, glue or correction fluid.

Write your name, Centre number and candidate number on the answer sheet in the spaces provided unless this has been done for you.

There are **forty** questions on this paper. Answer **all** questions. For each question there are four possible answers **A, B, C, and D**.

Choose the **one** you consider correct and record your choice in **soft pencil** on the separate answer sheet.

Read the instructions on the Answer Sheet very carefully.

Each correct answer will score one mark. A mark will not be deducted for a wrong answer.

Any rough working should be done in this booklet.

This document consists of **19** printed pages and **1** blank page.



- 1 A student has been asked to determine, as accurately as possible, the volume of a piece of wire. The wire is about 80 cm long and about 0.2 cm in diameter.

Which measuring instruments should the student use?

	length	diameter
A	metre rule	micrometer
B	metre rule	vernier callipers
C	micrometer	vernier callipers
D	vernier callipers	micrometer

- 2 Which quantity X is calculated using this equation?

$$X = \frac{\text{change in velocity}}{\text{time taken}}$$

- A** acceleration
B average velocity
C distance travelled
D speed
- 3 The graph shows the movement of a car over a period of 50 s.

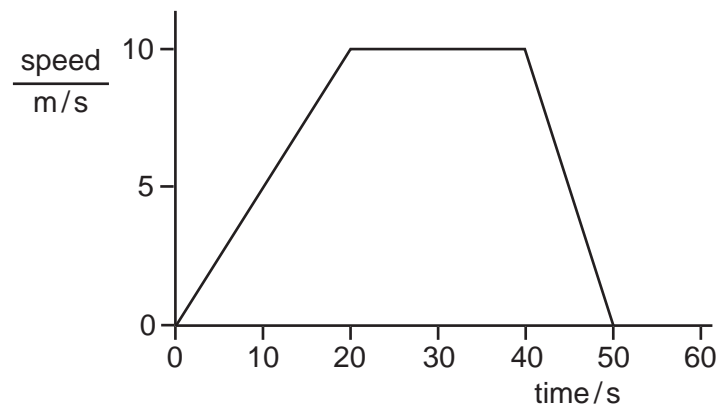

What was the distance travelled by the car while its speed was increasing?

- A** 10 m **B** 20 m **C** 100 m **D** 200 m
- 4 Which relationship defines gravitational field strength?
- A** mass \times 10
B mass \times weight
C mass / weight
D weight / mass

- 5 A measuring cylinder containing some water stands on a scale pan. A solid ball is lowered into the water.

The water level rises from the 30 cm^3 mark to the 40 cm^3 mark.

The scale reading increases from 100g to 180g.

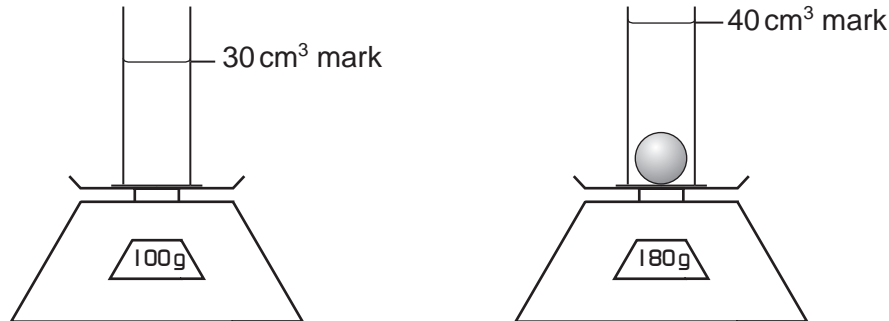

What is the density of the material of the ball?

- A** 2.0 g/cm^3 **B** 4.5 g/cm^3 **C** 8.0 g/cm^3 **D** 18 g/cm^3
- 6 Which is a statement of Newton's third law of motion?
- A** Every force causes a reaction.
B If there is no resultant force on a body then there is no acceleration.
C The forces acting on a body are always equal and opposite.
D To every action there is an equal but opposite reaction.
- 7 A car is travelling at constant speed along a road and drives over a large patch of oil. The driver applies the brakes to stop the car.

Compared to braking on a dry road, what may happen?

- A** The car slows down more quickly because of the greater friction between the tyres and the road.
B The car speeds up at first because of the reduced friction between the tyres and the road.
C The car takes longer to slow down because of the reduced friction between the tyres and the road.
D The car takes longer to slow down because the thinking distance of the driver is greater.

- 8 A horizontal pole is attached to the side of a building. There is a pivot **P** at the wall and a chain is connected from the end of the pole to a point higher up the wall.

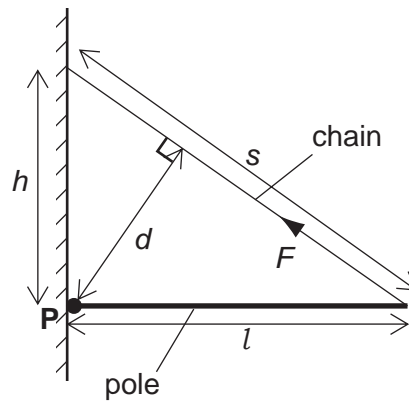

There is a tension force F in the chain.

What is the moment of the force F about the pivot **P**?

- A** $F \times d$ **B** $F \times h$ **C** $F \times l$ **D** $F \times s$
- 9 A spring balance is calibrated to give readings in newtons.

The graph shows how the length of the spring varies with the load.

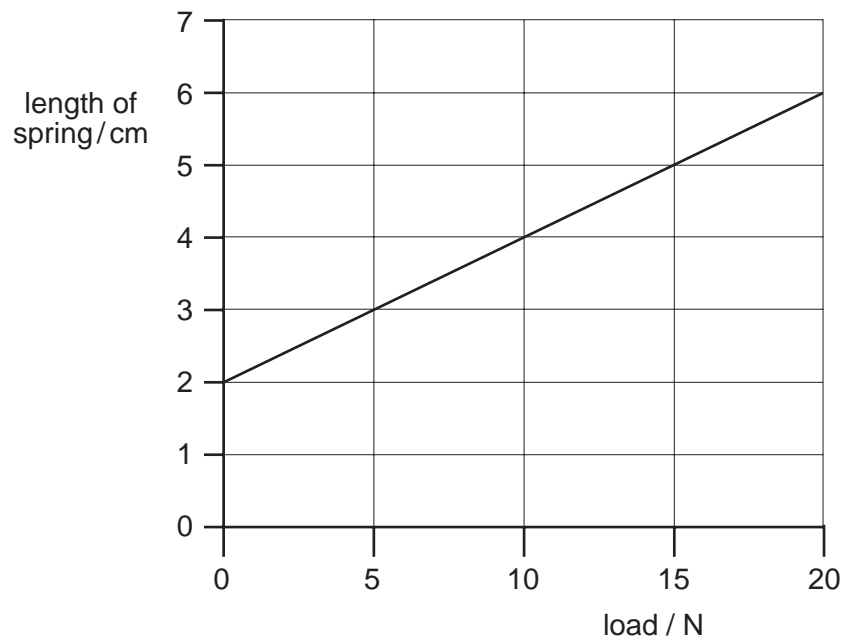

A load causes the spring of the balance to extend by 3 cm.

What is the balance reading?

- A** 3 N **B** 5 N **C** 10 N **D** 15 N

10 Forces of 3 N and 4 N are acting as shown in the diagram.

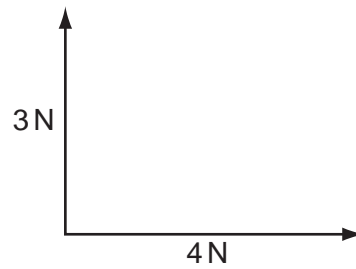

Which diagram may be used to find the resultant R of these two forces?

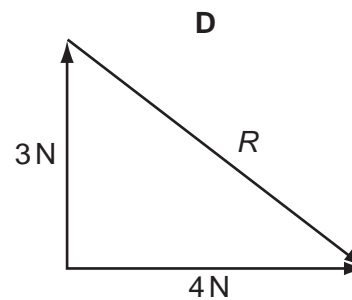
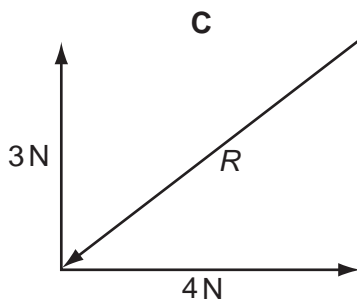
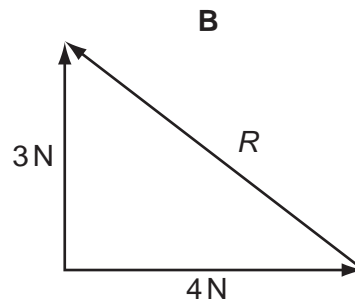
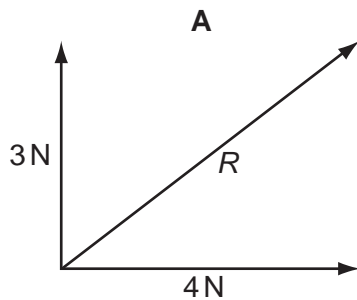

11 When a nucleus of Uranium-235 absorbs a neutron, nuclear fission occurs. In a typical reaction the total mass decreases by 3×10^{-28} kg.

Given that the speed of light c is 3×10^8 m/s, approximately how much energy is released?

- A 9×10^{-20} J
- B 2×10^{-13} J
- C 3×10^{-11} J
- D 3×10^{-5} J

- 12 A car is driven along a level road. The total energy input from the petrol is 60 kJ, and the car wastes 45 kJ of energy.

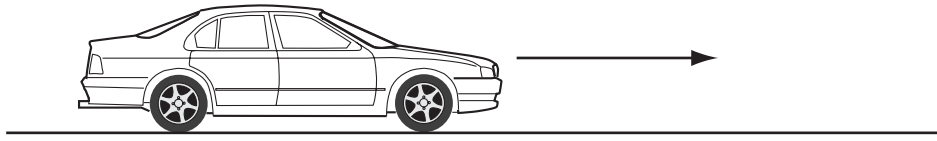

What is the efficiency of the car?

- A 15% B 25% C 45% D 75%
- 13 Which represents the main energy changes that take place in a coal-fired power station?
- A chemical → heat → kinetic → electrical
 B chemical → heat → light → electrical
 C chemical → kinetic → electrical → potential
 D kinetic → heat → light → electrical
- 14 The diagram shows a glass block resting on a table top.

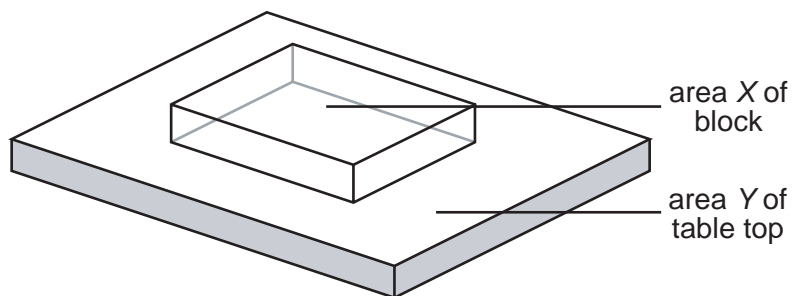

The area of the block in contact with the table is X and the area of the table top is Y .

The weight of the block is P and the weight of the table is Q .

Which expression gives the pressure exerted on the table by the block?

- A $\frac{P}{X}$ B $\frac{P}{Y}$ C $\frac{Q}{X}$ D $\frac{Q}{Y}$

- 15 The diagram shows the levels X and Y in a liquid manometer when the gas tap is opened.

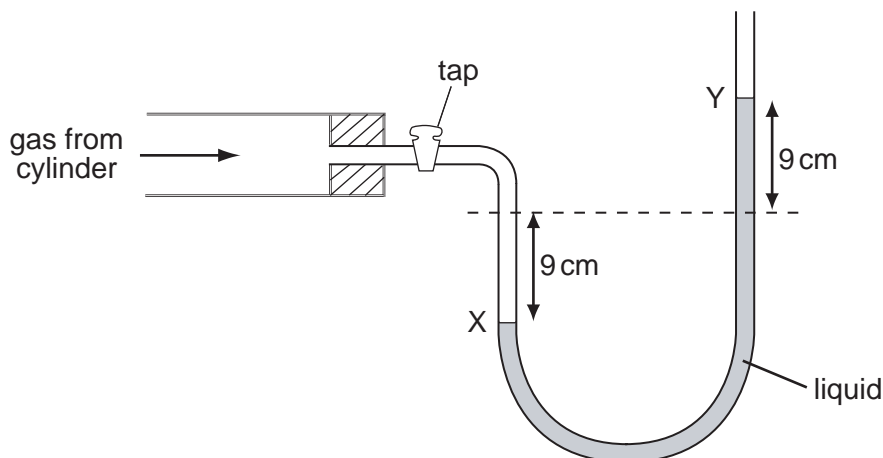

What is the pressure of the gas in the cylinder?

- A** 18 cm of liquid below atmospheric pressure
- B** 9 cm of liquid below atmospheric pressure
- C** 9 cm of liquid above atmospheric pressure
- D** 18 cm of liquid above atmospheric pressure
- 16 A substance consists of particles that are close together and moving past each other at random. The average speed of the particles is gradually increasing.
- What best describes the substance?
- A** a liquid being boiled to form a gas
- B** a liquid being heated
- C** a solid being heated
- D** a solid being melted to form a liquid
- 17 A liquid-in-glass thermometer consists of a bulb containing a liquid. The liquid can expand into a very thin capillary tube.

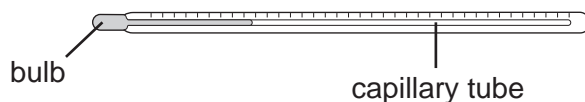

The liquid in the thermometer is replaced by another liquid that expands more for the same temperature rise.

The new thermometer will have

- A** greater sensitivity and greater range.
- B** greater sensitivity but less range.
- C** the same sensitivity and the same range.
- D** the same sensitivity but greater range.

18 The diagram shows a vacuum flask and an enlarged view of a section through the flask wall.

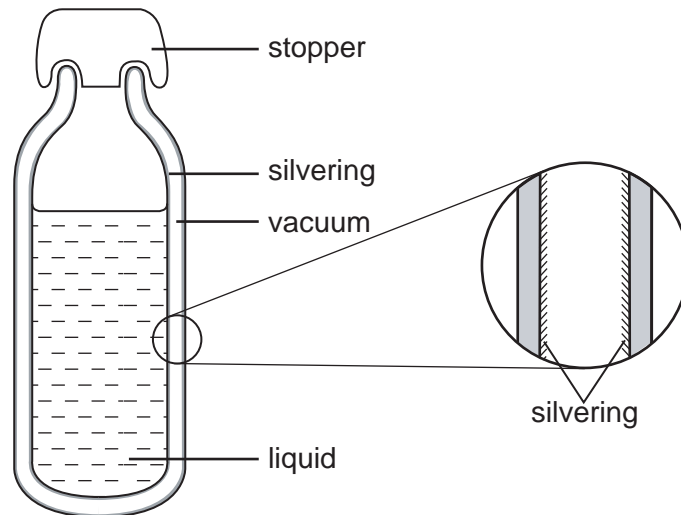

The main reason for the silvering is to reduce heat transfer by

- A conduction only.
- B radiation only.
- C conduction and convection.
- D convection and radiation.

19 The diagram shows a wave moving into shallower water.

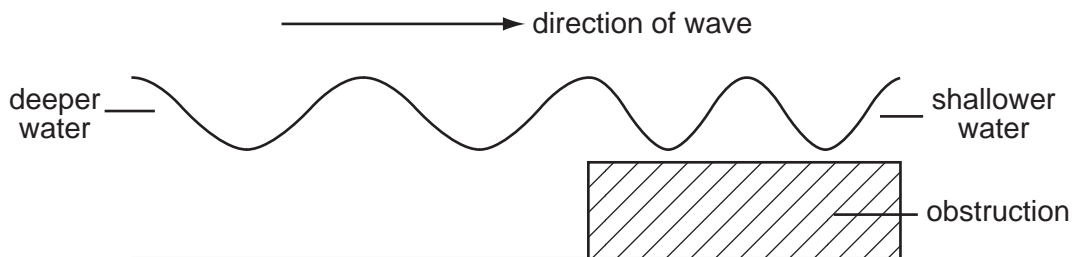

The wavelength of the waves is reduced because

- A both the frequency and the speed decrease.
- B both the frequency and the speed increase.
- C only the frequency increases.
- D only the speed decreases.

20 An image is formed in a plane mirror.

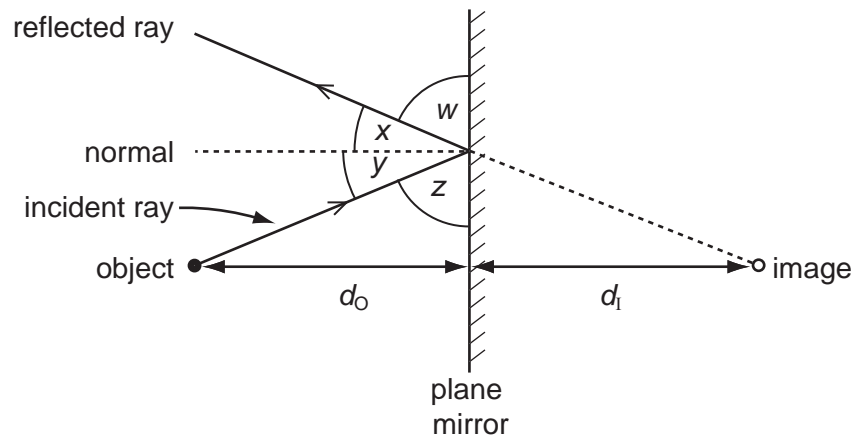

Which statement must be correct?

	angles	distances
A	$w = y$	$d_o = d_i$
B	$w = z$	d_o is greater than d_i
C	$x = y$	$d_o = d_i$
D	$x = z$	d_o is greater than d_i

- 21 A ray of light enters a glass block at an angle of incidence i producing an angle of refraction r in the glass.

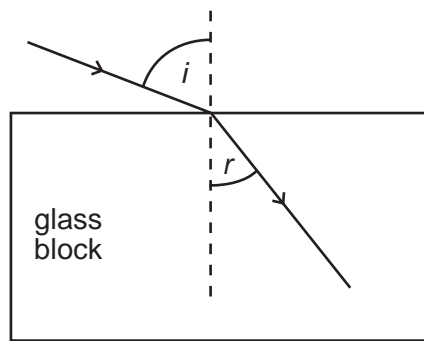

Several different values of i and r are measured, and a graph is drawn of $\sin i$ against $\sin r$.

Which graph is correct?

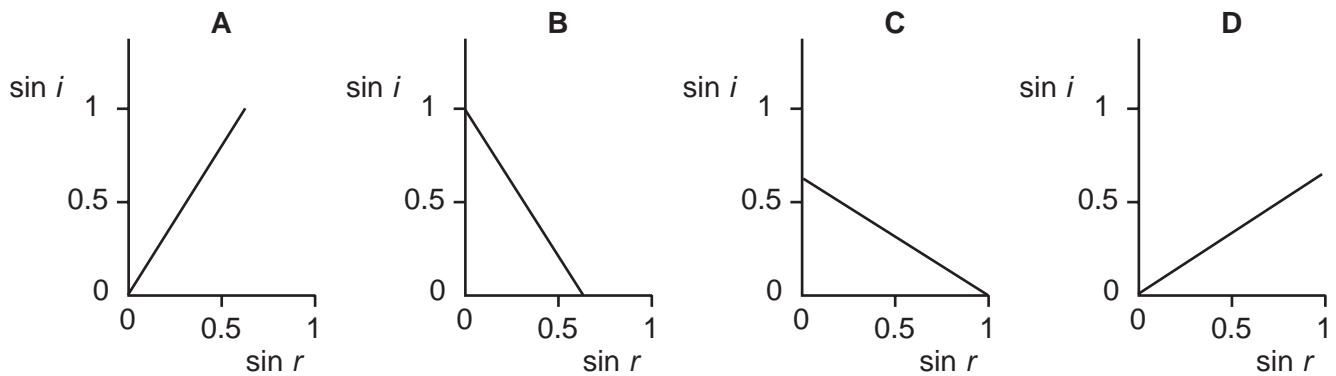

- 22 A student starts to draw a ray diagram for an object at O, near a thin convex lens, but is not sure whether the image is formed at X or at F.

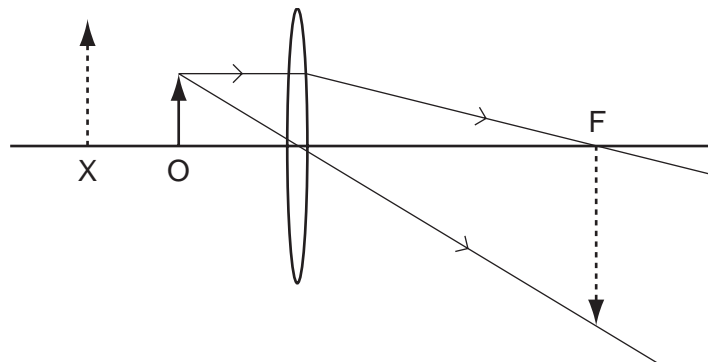

The correctly drawn image is

- A real and formed at F.
- B real and formed at X.
- C virtual and formed at F.
- D virtual and formed at X.

23 Which diagram correctly shows the dispersion of white light by a glass prism?

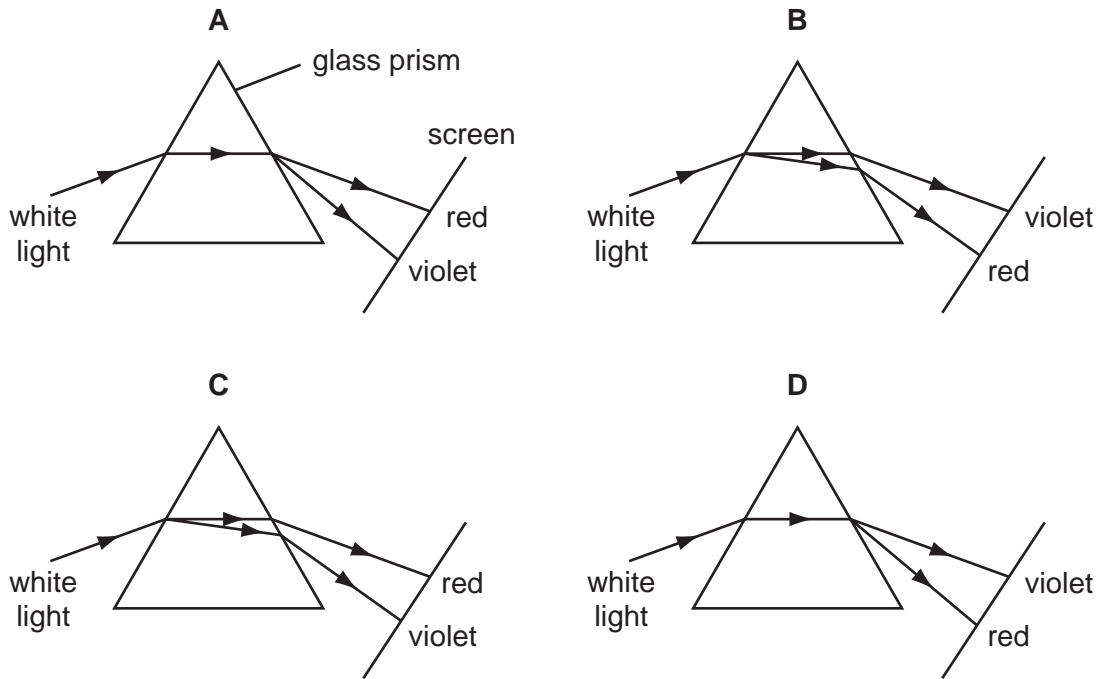

24 The diagram shows a loudspeaker that is producing a continuous sound wave of frequency 200 Hz in air.

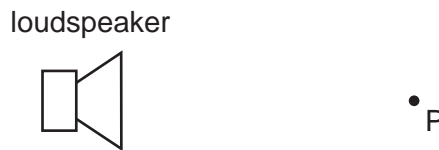

Which diagram best shows how the sound causes a molecule at P to move during $\frac{1}{200}$ s?

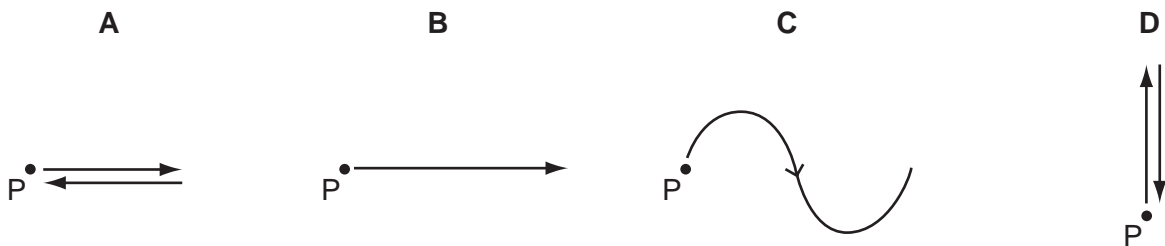

25 End X of a metal rod attracts the N-pole of a compass needle.

What does this show about the rod?

- A It could be made of copper but is not permanently magnetised.
- B It could be made of copper with a S-pole at X.
- C It could be made of steel but is not permanently magnetised.
- D It could be made of steel with a N-pole at X.

26 Four different substances are tested by using each as the core of an electromagnet.

The number of paper clips each holds is recorded when there is a current in the electromagnet and when the current is switched off.

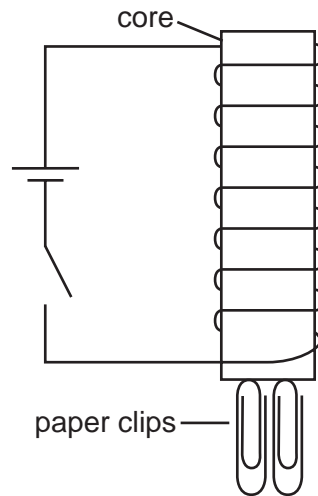

Which substance is the best for making the core of a transformer?

	number of paper clips held when there is a current in the electromagnet	number of paper clips held when current is switched off
A	8	4
B	6	0
C	5	1
D	4	0

27 On a stormy day, a large, positively-charged cloud is above a tree.

An electrical charge is induced on the tree as charged particles flow through it.

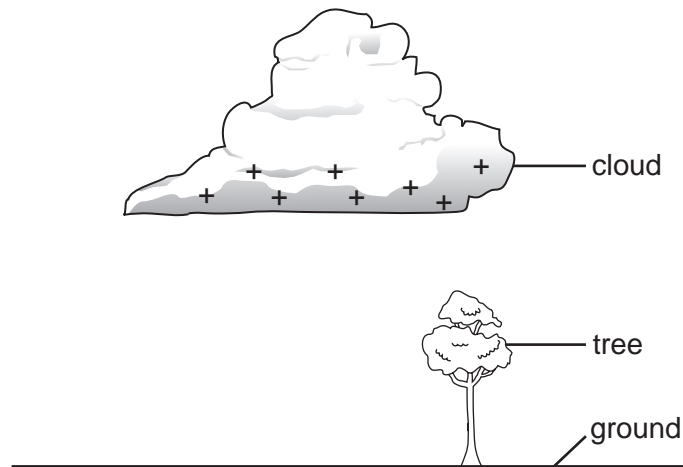

What is the charge induced on the tree and how do the charged particles move?

	charge on tree	movement of charged particles through tree
A	negative	negatively charged particles move down the tree
B	negative	negatively charged particles move up the tree
C	positive	positively charged particles move down the tree
D	positive	positively charged particles move up the tree

28 The diagram shows two resistors connected in series with a cell.

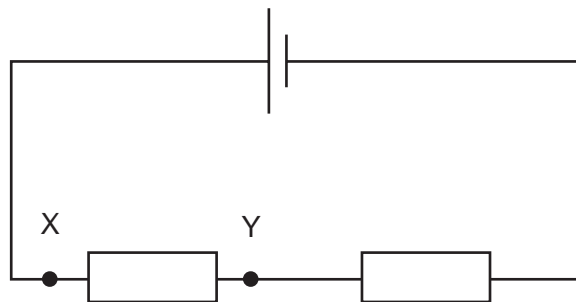

Which statement defines the potential difference across XY?

- A** the power needed to drive a unit charge through the cell
- B** the power needed to drive a unit charge between X and Y
- C** the work done in driving a unit charge through the cell
- D** the work done in driving a unit charge between X and Y

29 Which two resistor combinations have the same resistance between X and Y?

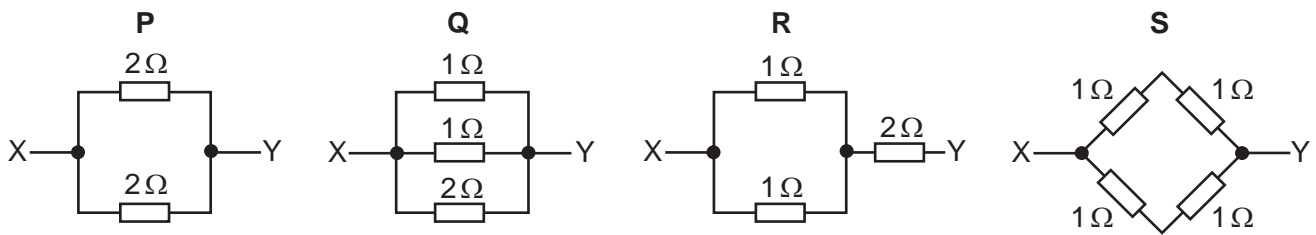

- A P and Q
- B P and S
- C Q and R
- D R and S

30 In order to turn off both lamps, which is the safest switch position?

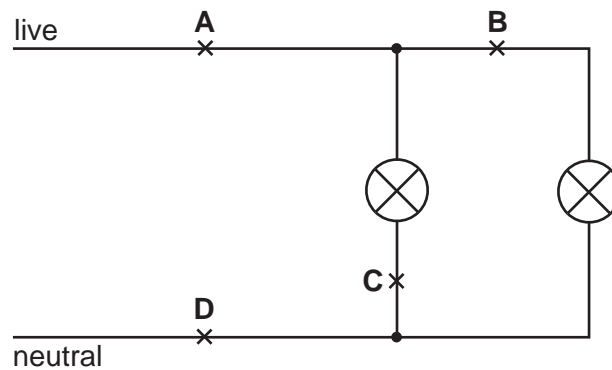

31 The diagram shows a beam of electrons entering a magnetic field.

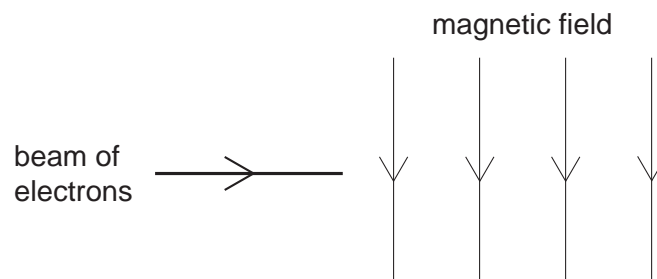

What is the effect of the magnetic field on the electrons?

- A They are deflected into the plane of the diagram.
- B They are deflected out of the plane of the diagram.
- C They are deflected towards the bottom of the diagram.
- D They are deflected towards the top of the diagram.

- 32 A student pushes the N-pole of a bar magnet into the end Q of a long solenoid and observes a deflection to the right on the sensitive ammeter.

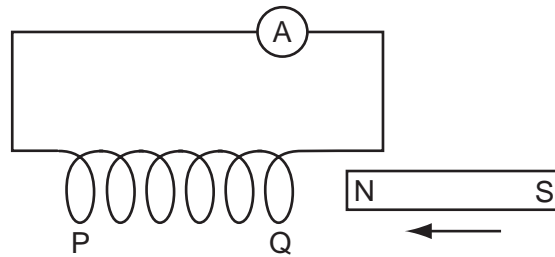

What will produce a deflection in the same direction?

- A pulling the N-pole out of end Q
- B pulling the S-pole out of end P
- C pushing the N-pole into end P
- D pushing the S-pole into end P

33 A simple a.c. generator produces an alternating e.m.f. as shown.

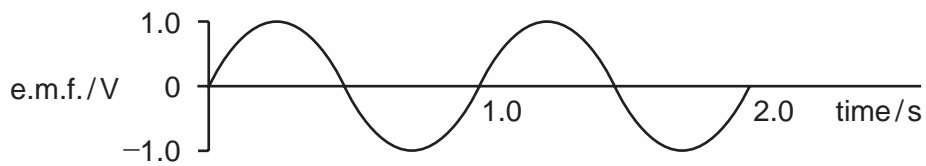

The speed of the generator is doubled.

Which graph best represents the new output?

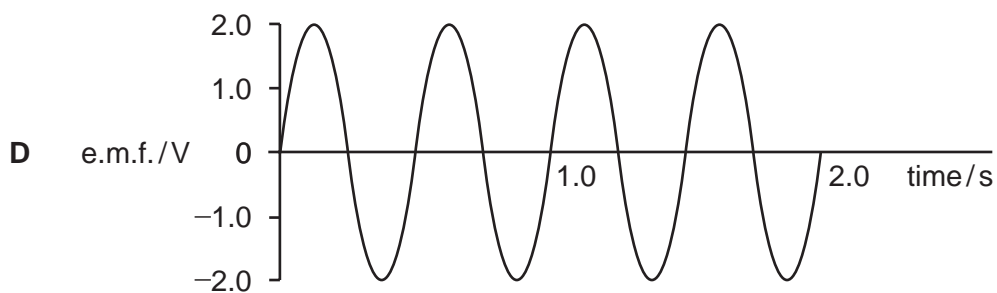
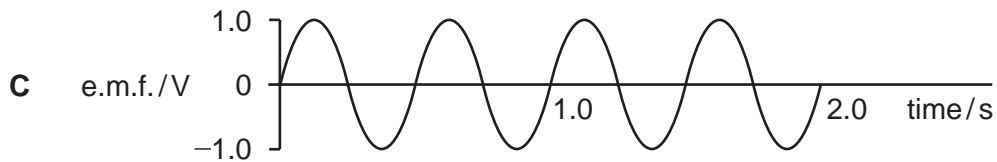
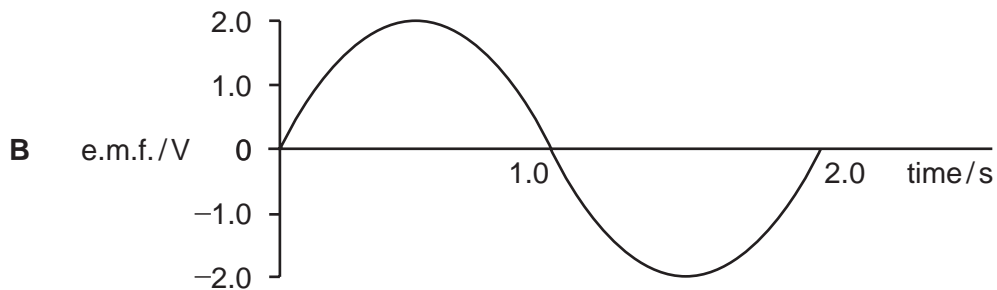
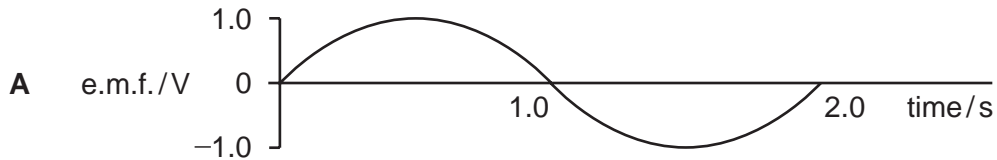

34 A step-down transformer changes 240 V a.c. to 12 V a.c. There are 600 turns on the primary coil.

How many turns are on the secondary coil?

- A** 20 **B** 30 **C** 600 **D** 12 000

35 Why are high voltages and low currents used to transmit electrical energy over long distances?

- A to increase the electromagnetic radiation
- B to increase the speed at which electrons move
- C to reduce heat loss from the power line
- D to reduce the resistance of the power line

36 A variable potential divider has a sliding contact S that can be moved between end P and end Q. It is connected to a constant 6 V power supply, as shown below.

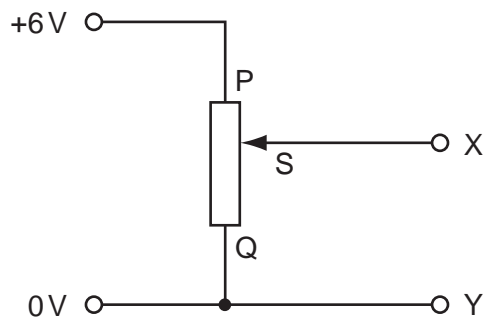

What happens to the p.d. between X and Y as S moves down from P to Q?

- A It decreases gradually from 6 V to 0 V.
- B It rises gradually from 0 V to 6 V.
- C It stays constant at 0 V.
- D It stays constant at 6 V.

37 A capacitor C charges when it is connected to a d.c. power supply.

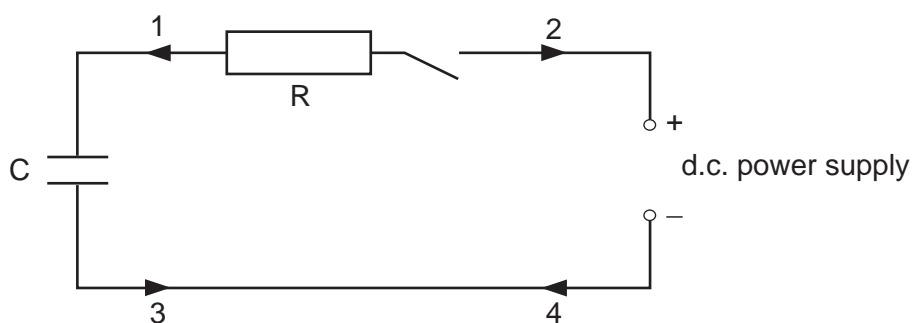

Which arrows show the direction of the conventional current when the capacitor is charging?

- A 1 and 3
- B 1 and 4
- C 2 and 3
- D 2 and 4

- 38 Two types of emission from a radioactive source are separated by passing them through a magnetic field.

The deflections are shown in the diagram.

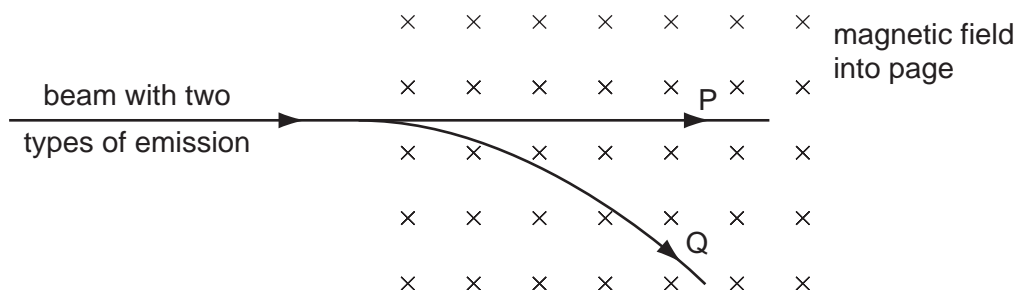

What are the emissions P and Q?

	emission P	emission Q
A	alpha-particles	gamma-rays
B	beta-particles	gamma-rays
C	gamma-rays	alpha-particles
D	gamma-rays	beta-particles

- 39 A narrow beam of alpha-particles is fired at a thin piece of gold foil.

Which is the final direction of the largest number of alpha-particles?

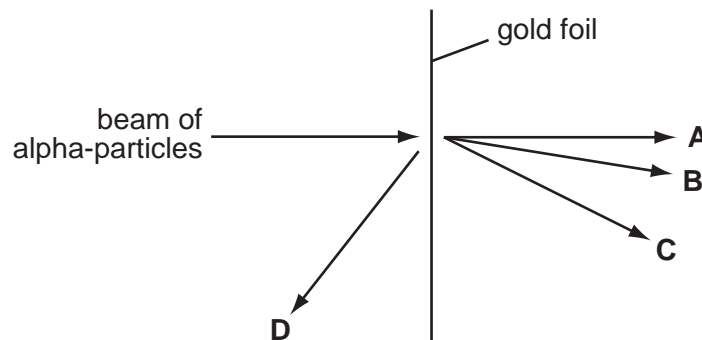

- 40 Ra decays with a half-life of 1600 s.
 Rn decays with a half-life of 52 s.
 Po decays with a half-life of 9.1 s.
 Pb decays with a half-life of 10.6 h.

The changing count rate for one of these radioactive nuclides is shown in the graph.

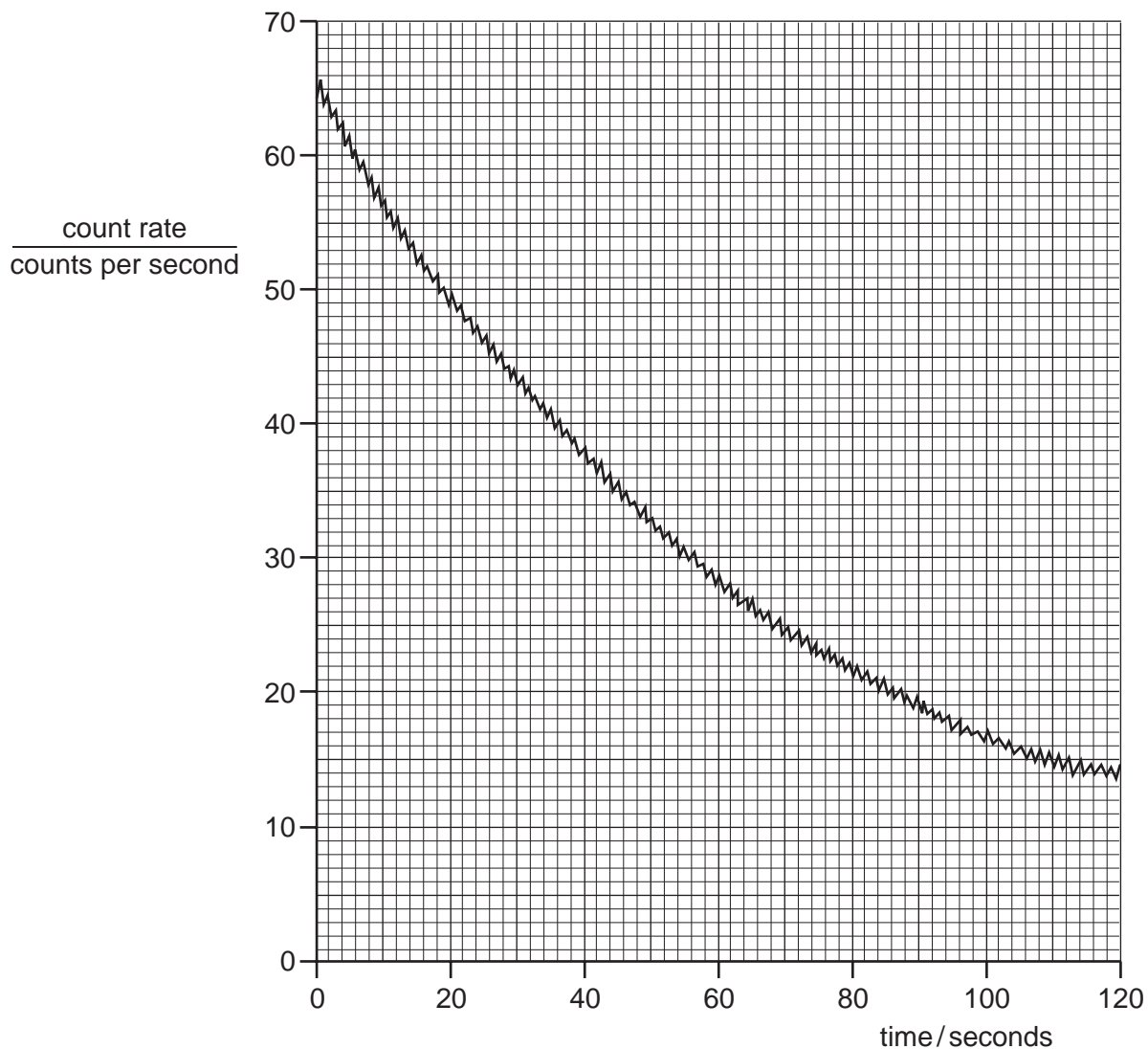

From the half-life shown by the graph, which was the decaying radioactive nuclide?

- A** Ra **B** Rn **C** Po **D** Pb

BLANK PAGE

Copyright Acknowledgements:

Every reasonable effort has been made to trace all copyright holders. The publishers would be pleased to hear from anyone whose rights we have unwittingly infringed.

University of Cambridge International Examinations is part of the University of Cambridge Local Examinations Syndicate (UCLES), which is itself a department of the University of Cambridge.