



Cambridge International Examinations
Cambridge International General Certificate of Secondary Education

PHYSICS

0625/22

Paper 2 Multiple Choice (Extended)

October/November 2018

45 minutes

Additional Materials: Multiple Choice Answer Sheet
 Soft clean eraser
 Soft pencil (type B or HB recommended)

* 3 0 8 1 8 7 4 3 5 5 *

READ THESE INSTRUCTIONS FIRST

Write in soft pencil.

Do not use staples, paper clips, glue or correction fluid.

Write your name, Centre number and candidate number on the Answer Sheet in the spaces provided unless this has been done for you.

DO NOT WRITE IN ANY BARCODES.

There are **forty** questions on this paper. Answer **all** questions. For each question there are four possible answers **A, B, C** and **D**.

Choose the **one** you consider correct and record your choice in **soft pencil** on the separate Answer Sheet.

Read the instructions on the Answer Sheet very carefully.

Each correct answer will score one mark. A mark will not be deducted for a wrong answer.

Any rough working should be done in this booklet.

Electronic calculators may be used.

Take the weight of 1.0 kg to be 10 N (acceleration of free fall = 10 m/s^2).

The syllabus is approved for use in England, Wales and Northern Ireland as a Cambridge International Level 1/Level 2 Certificate.

This document consists of **16** printed pages.

- 1 The diagram shows part of a micrometer screw gauge.

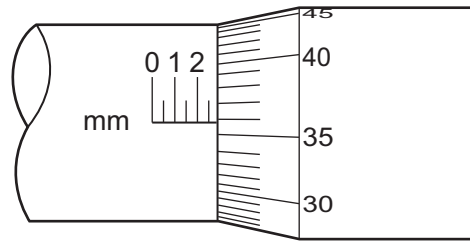

What is the smallest reading that can be achieved using this micrometer screw gauge?

- A** 0.0001 mm **B** 0.01 mm **C** 0.1 mm **D** 1 mm
- 2 The speed-time graph shows the motion of a car.

At which time is its acceleration greatest?

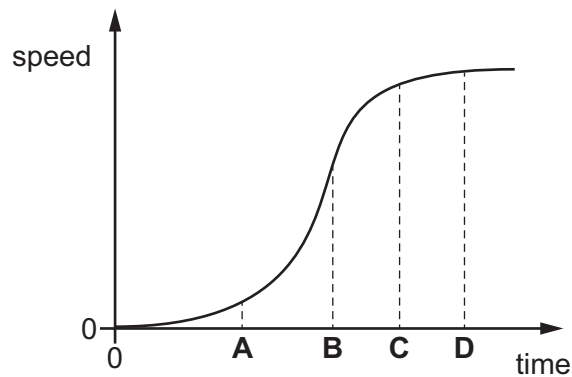

- 3 An athlete runs at a speed of 8 m/s for 10 s, and then at a speed of 6 m/s for 12 s.

Which calculation gives the average speed of the athlete in m/s?

- A** $\frac{8+6}{2}$
- B** $\frac{(8 \times 10) + (6 \times 12)}{22}$
- C** $\frac{(8 \div 10) + (6 \div 12)}{22}$
- D** $\frac{(10 \div 8) + (12 \div 6)}{22}$

- 4 A helium balloon is tied to a top-pan balance. A metal block of mass 100 g is placed on the balance. The reading on the balance is 91 g.

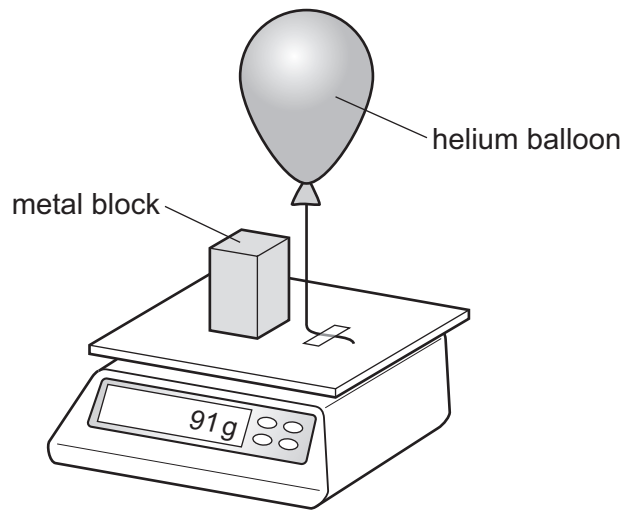

Which statement can be deduced from this experiment?

- A** The balloon exerts a downward force of 0.09 N on the top-pan balance.
B The helium has a mass of -9 g.
C The helium has a mass of $+9$ g.
D The resultant downward force on the top-pan balance is 0.91 N.
- 5 The diagram shows four blocks of different metals. Each block has a mass of 12 g.

Which metal has the largest density?

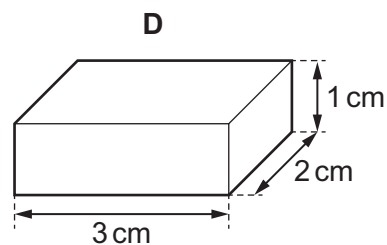
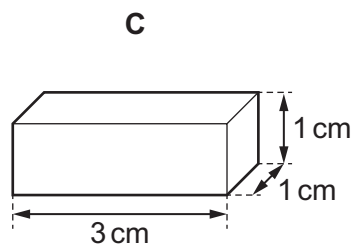
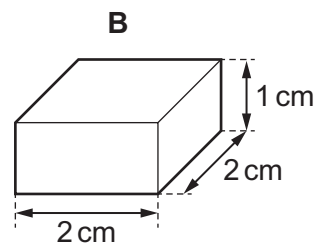
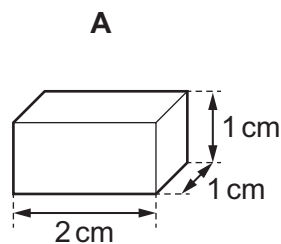

- 6 The graph shows how the length of a spring changes when the stretching force is increased.

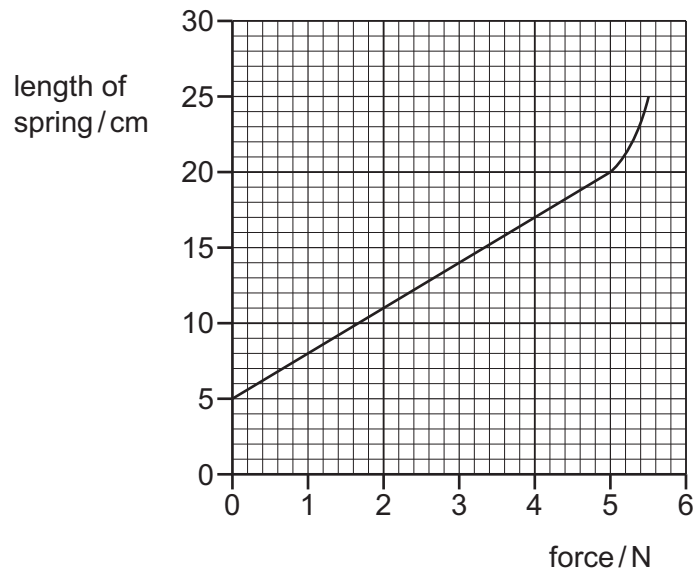

In the Hooke's law region, what is the spring constant for this spring?

- A** 0.20 N/cm **B** 0.22 N/cm **C** 0.28 N/cm **D** 0.33 N/cm
- 7 Point X is the centre of mass of a lamina in the shape of a triangle with sides of equal length. The top of the triangle is cut off along the dotted line shown.

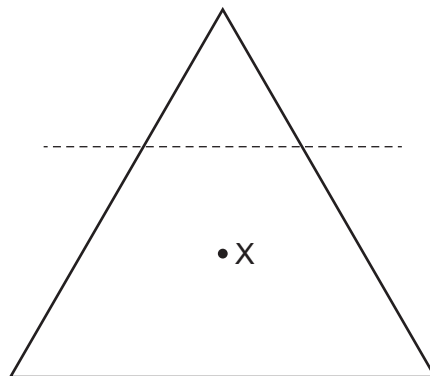

What happens to the centre of mass, X?

- A** moves towards the bottom of the page
B moves to the left
C moves to the right
D moves towards the top of the page

- 8 An object of mass 3.0 kg, travelling at a speed of 6.0 m/s, collides with an object of mass 2.0 kg, travelling in the opposite direction at a speed of 2.0 m/s.



The objects stick together during the collision.

What is the speed and direction of the combined mass after the collision?

- A 4.4 m/s to the left
 B 4.4 m/s to the right
 C 2.8 m/s to the left
 D 2.8 m/s to the right
- 9 Which device is designed to convert chemical energy into kinetic energy?
- A an a.c. generator
 B a battery-powered torch
 C a car engine
 D a wind-up mechanical clock
- 10 The diagram shows a pendulum.

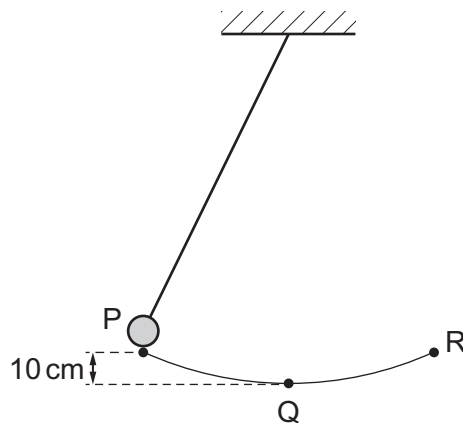

The pendulum swings from P to Q to R and back to P.

P is 10 cm higher than Q.

At which speed does the pendulum bob pass through Q?

- A 0.44 m/s B 1.0 m/s C 1.4 m/s D 2.0 m/s

- 11 A crane on a building site lifts bricks of total mass 200 kg, initially at rest on the ground, with uniform acceleration.

When the bricks are 5.0 m from the ground, they have a speed of 5.0 m/s.

How much work is done during this process?

- A 2.5 kJ B 10.0 kJ C 12.5 kJ D 35 kJ
- 12 A manometer is used to measure the pressure of a gas supply.

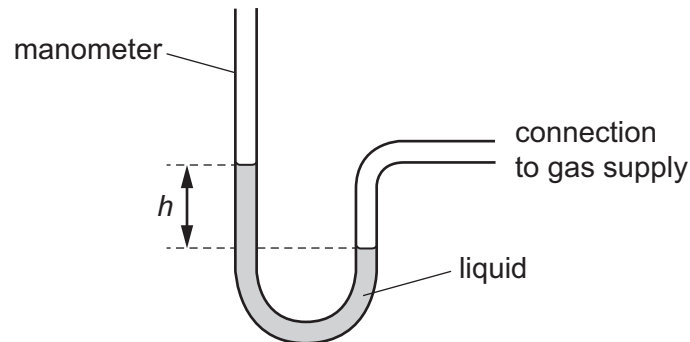

Which change gives a greater value of height h ?

- A using a less dense liquid
 B using a more dense liquid
 C using a narrower tube
 D using a wider tube
- 13 A washbasin has an exit pipe covered with a plug of area 12 cm^2 . A chain is attached to the centre of the plug to assist in pulling the plug away from the exit hole. The washbasin contains water to a depth of 0.080 m.

The density of the water is 1000 kg/m^3 .

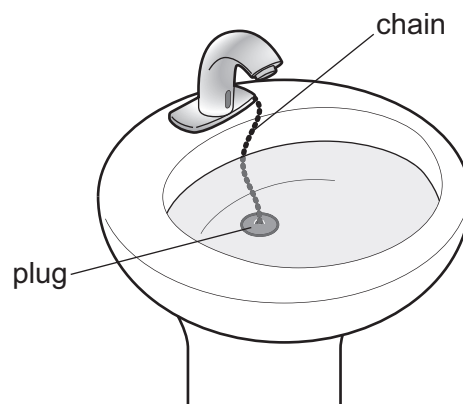

What is the force acting on the plug due to the water?

- A 0.96 N B 800 N C 9600 N D 80000 N

14 Diagram 1 shows apparatus being used to observe smoke particles.

Diagram 2 shows how a smoke particle moves randomly.

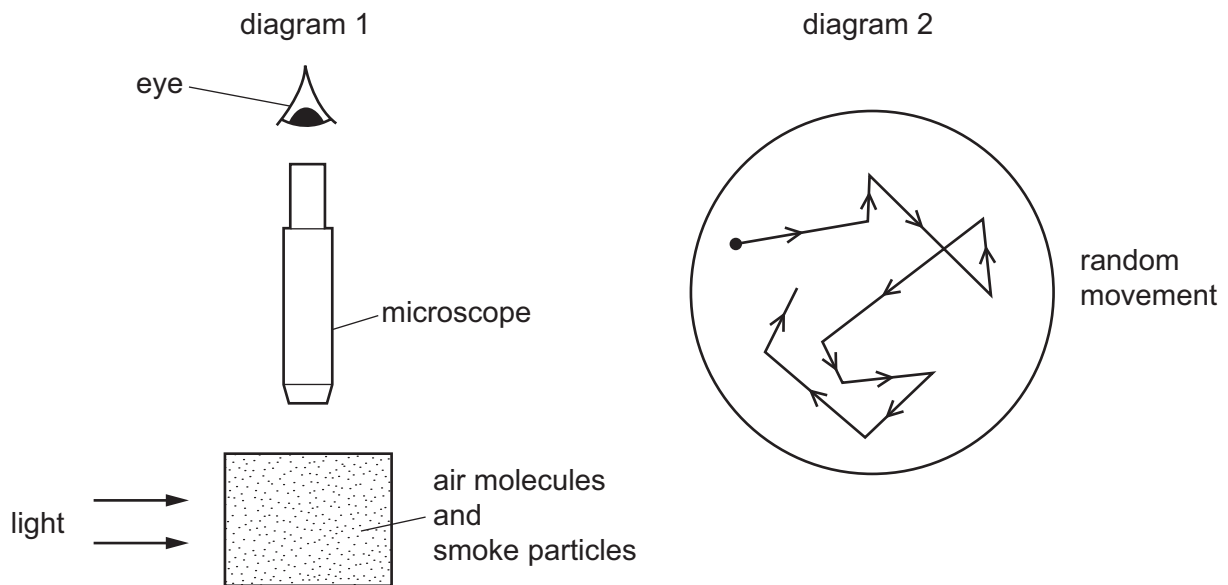

Why do the smoke particles move randomly?

- A They are hit by air molecules.
- B They are less dense than air.
- C They are moved by convection currents.
- D They gain energy from the light.

15 A closed container of gas is heated. The pressure of the gas increases.

Which statement explains this increase in pressure?

- A The changes in the momentum of the gas molecules striking the walls of the container increase.
- B The forces of attraction between the gas molecules and the walls of the container increase.
- C The gas molecules collide with each other more frequently.
- D The gas molecules lose more energy when they strike the walls of the container.

- 16 The metal lid on a glass jar is difficult to unscrew.

The jar is placed in a warm oven until the jar and the lid reach the same temperature. The lid is now easily unscrewed.

Which property accounts for this?

- A thermal capacity of the jar
 - B thermal capacity of the lid
 - C thermal conduction
 - D thermal expansion
- 17 A block of iron of mass M is heated and gains 10 kJ of internal energy. The temperature of the block rises by $\theta^\circ\text{C}$.

A second block of iron of mass $2M$ is heated and gains 5.0 kJ of internal energy.

What is the temperature rise of the second block in $^\circ\text{C}$?

- A $\frac{\theta}{4}$
 - B $\frac{\theta}{2}$
 - C 2θ
 - D 4θ
- 18 Which factors affect the sensitivity of a thermometer?
- 1 the diameter of the bore of the tube
 - 2 the length of the capillary tube
 - 3 the thickness of the bulb wall
- A 1 only
 - B 1 and 2 only
 - C 1 and 3 only
 - D 1, 2 and 3
- 19 Which statement about convection is **not** correct?
- A It enables water in a pan on a cooker to get evenly heated.
 - B It happens in liquids and gases.
 - C It means that heat rises.
 - D It occurs because the density of a fluid decreases when it is heated.

- 20 A lamp has a metal filament that glows when heated by an electric current.

The middle of the filament is at a very high temperature. The ends of the filament, which are connected to the base of the lamp, are cooler.

Which statement is correct?

- A** Some thermal energy is conducted to the base of the lamp.
- B** The filament radiates energy equally at all points along its length.
- C** The lamp transfers all of the electrical energy it receives into light energy.
- D** When the voltage across the filament is halved, the power output is halved.
- 21 Plane water waves travel from a shallow region into a deeper region. They travel more quickly in the deeper water.

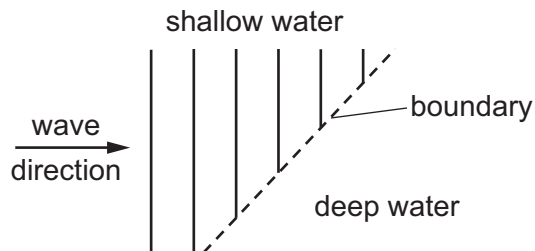

Which diagram shows the wave pattern in the deeper water?

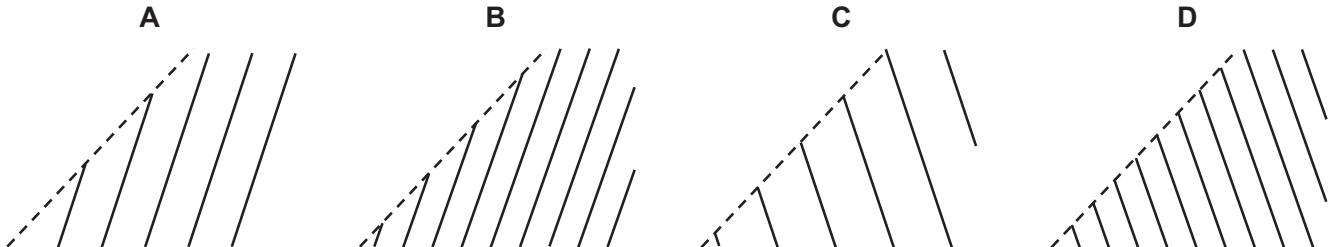

- 22 A thin converging lens has a focal length of 6.0 cm. An observer looks through the lens at an object which is placed 4.0 cm from the lens.

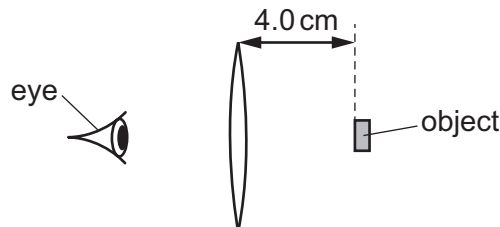

Which description of the image that is observed is correct?

- A** diminished and inverted
- B** diminished and virtual
- C** enlarged and inverted
- D** enlarged and virtual

- 23** A transmitter produces radio waves of wavelength 1500 m. It takes the waves 0.025 s to travel from the transmitter to a radio receiver.

What is the distance between the radio transmitter and the receiver?

- A** 5.0×10^3 m **B** 2.0×10^5 m **C** 7.5×10^6 m **D** 1.1×10^{10} m

- 24** Different parts of the electromagnetic spectrum are used for different purposes. Below are four statements about parts of the spectrum.

statement 1: Infra-red waves are used in television remote controllers.

statement 2: Radio waves are used to transmit television pictures from satellites to Earth.

statement 3: Ultraviolet waves are used for intruder alarms.

statement 4: X-rays are used for security checks.

Which statements are correct?

- A** 1 and 2 **B** 1 and 4 **C** 2 and 3 **D** 3 and 4

- 25** A sheet of ice floats on water. A source of sound S is positioned at the edge of the ice sheet.

Four microphones are placed equal distances from S.

Which microphone detects the sound from S first?

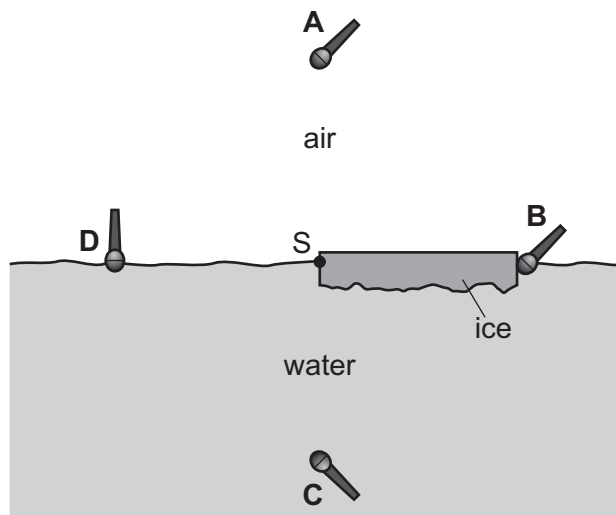

- 26 The diagram shows a bar magnet at rest on a smooth horizontal surface. A length of soft-iron wire is held parallel to the magnet.

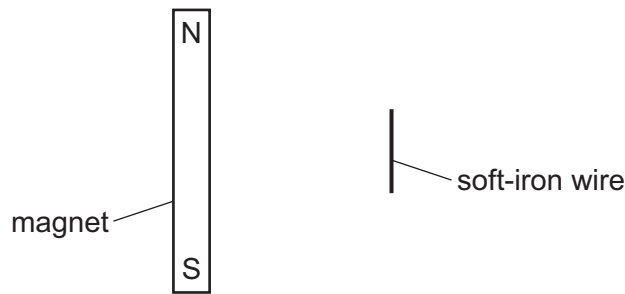

The wire is released.

What happens?

- A The wire moves away from the magnet.
 - B The wire moves towards the magnet.
 - C The wire's centre stays in its present position and the wire rotates through 90° in a clockwise direction.
 - D The wire's centre stays in its present position and the wire rotates through 90° in an anticlockwise direction.
- 27 The diagram shows point X between two charged plates.

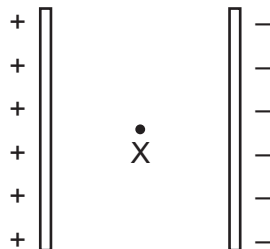

Which diagram shows the electric field pattern near point X?

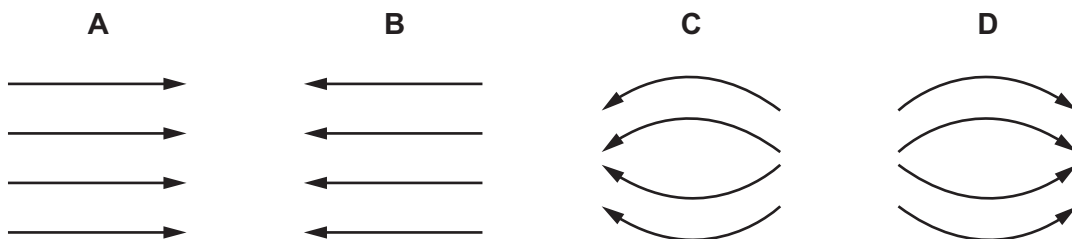

- 28 A bar magnet is placed inside a current-carrying coil. The diagram shows four different experiments.

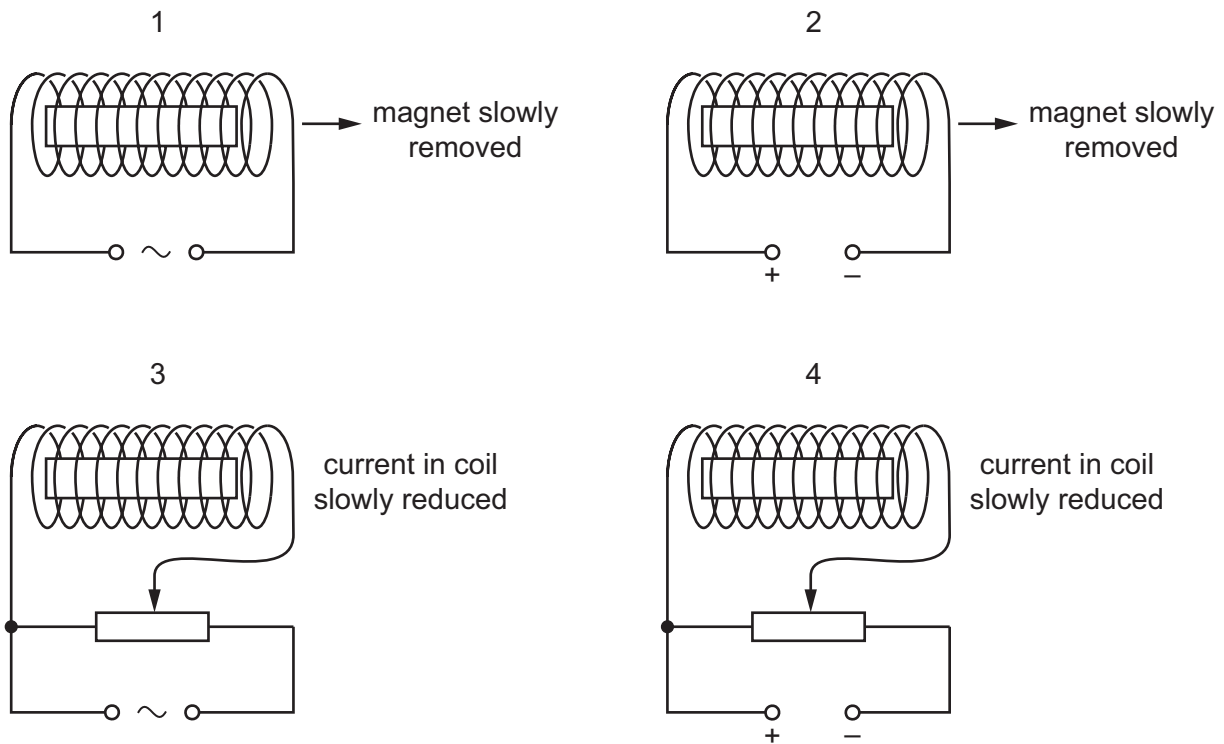

In which experiments is the magnet demagnetised?

- A 1 and 2 B 1 and 3 C 2 and 4 D 3 and 4
- 29 Copper wire is available in fixed lengths but in various diameters d . Each diameter has a different resistance R .

Which relationship between R and d is correct?

- A R is directly proportional to d .
- B R is directly proportional to d^2 .
- C R is inversely proportional to d .
- D R is inversely proportional to d^2 .
- 30 A student investigates the resistance of a lamp.

Which row states how the meters must be connected?

	ammeter	voltmeter
A	in parallel with the lamp	in parallel with the lamp
B	in parallel with the lamp	in series with the lamp
C	in series with the lamp	in parallel with the lamp
D	in series with the lamp	in series with the lamp

- 31 The circuit shown is used to change the voltage V_{out} as the temperature of device X changes.

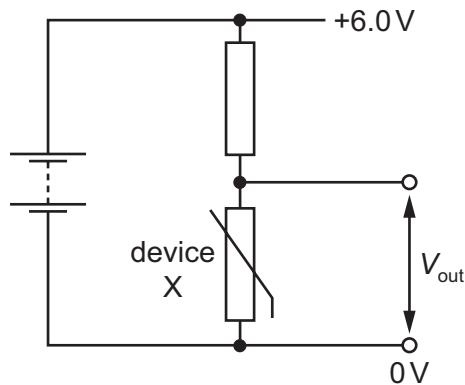

Which row is correct?

	name of this type of circuit	name of device X
A	potential divider	fuse
B	potential divider	thermistor
C	variable resistor	fuse
D	variable resistor	thermistor

- 32 The circuit diagram shows a d.c. power supply connected to two resistors R_1 and R_2 and four diodes.

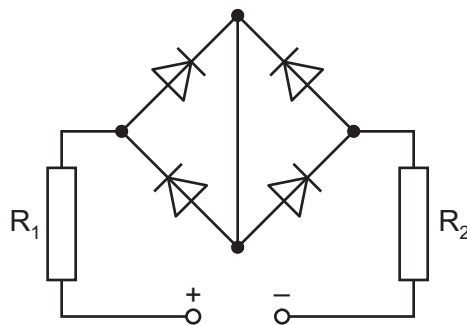

Which statement is correct?

- A** There is a current in R_1 and a current in R_2 .
B There is a current in R_1 but no current in R_2 .
C There is no current in R_1 but a current in R_2 .
D There is no current in R_1 and no current in R_2 .

33 A logic gate has inputs 0,0 and an output 1.

Which two types of logic gate behave in this way?

- A OR, AND
- B OR, NAND
- C NOR, AND
- D NOR, NAND

34 Either a fuse or a circuit-breaker can be used to protect electrical cables from large currents that could cause overheating.

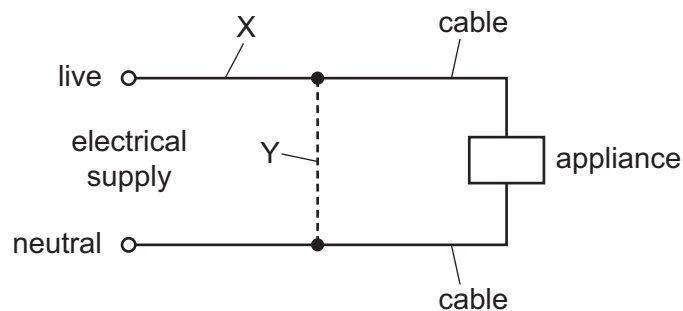

When a fuse is used, where should it be connected, and when a circuit-breaker is used, where should it be connected?

	position of fuse	position of circuit-breaker
A	X	X
B	X	Y
C	Y	X
D	Y	Y

35 Electrical power is transmitted at 400 kV and transformed down to 240 V before being delivered to consumers.

Which statement is correct?

- A A 400 kV cable requires less insulation than a 240 V cable.
- B Birds are subject to a high-voltage shock when resting on a high-voltage cable.
- C The current in the transmission wires is equal to the current delivered to the consumers.
- D With a 400 kV transmission system, a smaller proportion of the energy is used to heat the atmosphere than with a 240 V system.

36 The diagram shows a coil of wire between the poles of a magnet.

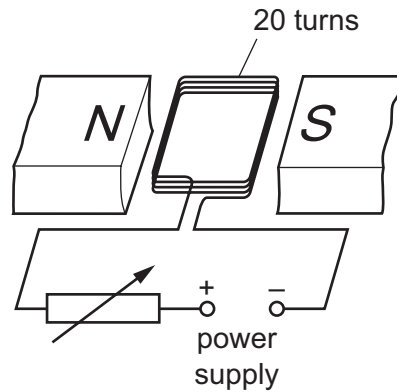

The coil consists of 20 turns of insulated wire.

The coil is connected to a variable resistor and a power supply.

How can the turning effect on the coil be increased?

- A by moving the poles of the magnet closer to the coil
- B by reducing the number of turns on the coil while keeping the current constant
- C by increasing the resistance of the variable resistor
- D by reversing the terminals of the power supply

37 Which diagram represents the structure of a neutral atom?

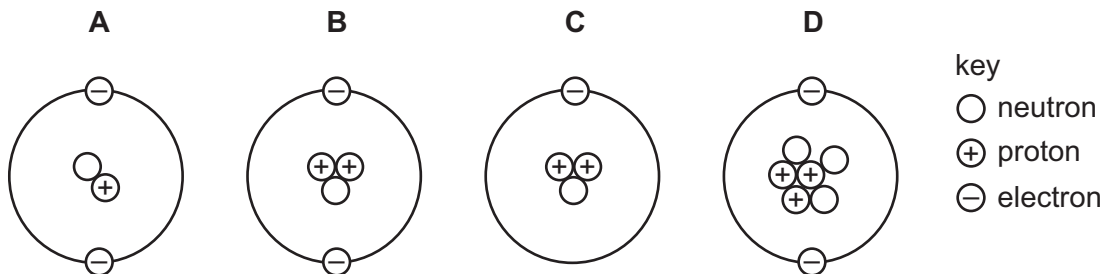

38 A radioactive nucleus ${}_{86}^{220}\text{Rn}$ decays in two stages to produce ${}_{82}^{212}\text{Pb}$.

Which two particles are emitted in this process?

- A an α -particle and a β -particle
- B an α -particle and a proton
- C two α -particles
- D two β -particles

- 39 The diagram shows the paths of three different types of radiation X, Y and Z.

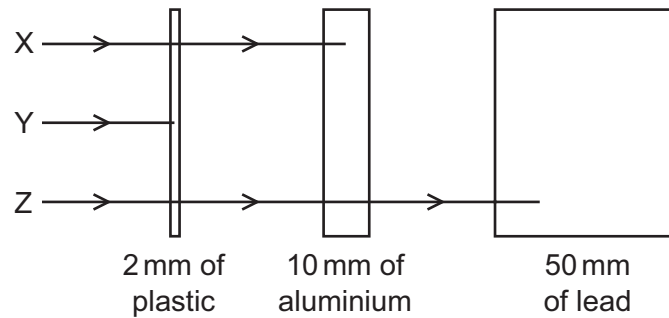

Which row correctly identifies X, Y and Z?

	X	Y	Z
A	α -particles	β -particles	γ -rays
B	β -particles	α -particles	γ -rays
C	β -particles	γ -rays	α -particles
D	γ -rays	α -particles	β -particles

- 40 The count rate measured when near a radioactive source drops from 542 counts per minute to 94 counts per minute in 12 hours. The background count remains constant at 30 counts per minute.

What is the half-life of the source?

- A** 2 hours **B** 3 hours **C** 4 hours **D** 8 hours

Permission to reproduce items where third-party owned material protected by copyright is included has been sought and cleared where possible. Every reasonable effort has been made by the publisher (UCLES) to trace copyright holders, but if any items requiring clearance have unwittingly been included, the publisher will be pleased to make amends at the earliest possible opportunity.

To avoid the issue of disclosure of answer-related information to candidates, all copyright acknowledgements are reproduced online in the Cambridge International Examinations Copyright Acknowledgements Booklet. This is produced for each series of examinations and is freely available to download at www.cie.org.uk after the live examination series.

Cambridge International Examinations is part of the Cambridge Assessment Group. Cambridge Assessment is the brand name of University of Cambridge Local Examinations Syndicate (UCLES), which is itself a department of the University of Cambridge.