



UNIVERSITY OF CAMBRIDGE INTERNATIONAL EXAMINATIONS  
International General Certificate of Secondary Education

---

**PHYSICS**

**0625/12**

Paper 1 Multiple Choice

**May/June 2011**

**45 minutes**

Additional Materials:      Multiple Choice Answer Sheet  
   Soft clean eraser  
   Soft pencil (type B or HB recommended)



---

**READ THESE INSTRUCTIONS FIRST**

Write in soft pencil.

Do not use staples, paper clips, highlighters, glue or correction fluid.

Write your name, Centre number and candidate number on the Answer Sheet in the spaces provided unless this has been done for you.

There are **forty** questions on this paper. Answer **all** questions. For each question there are four possible answers **A, B, C** and **D**.

Choose the **one** you consider correct and record your choice in **soft pencil** on the separate Answer Sheet.

**Read the instructions on the Answer Sheet very carefully.**

Each correct answer will score one mark. A mark will not be deducted for a wrong answer.

Any rough working should be done in this booklet.

---

This document consists of **19** printed pages and **1** blank page.



- 1 A tennis player hits a ball hard and 0.40 s later hears the echo from a wall.



The speed of sound in air is 330 m/s.

How far away is the player from the wall?

- A 66 m            B 132 m            C 264 m            D 825 m
- 2 The diagram shows an enlarged drawing of the end of a metre rule. It is being used to measure the length of a small feather.

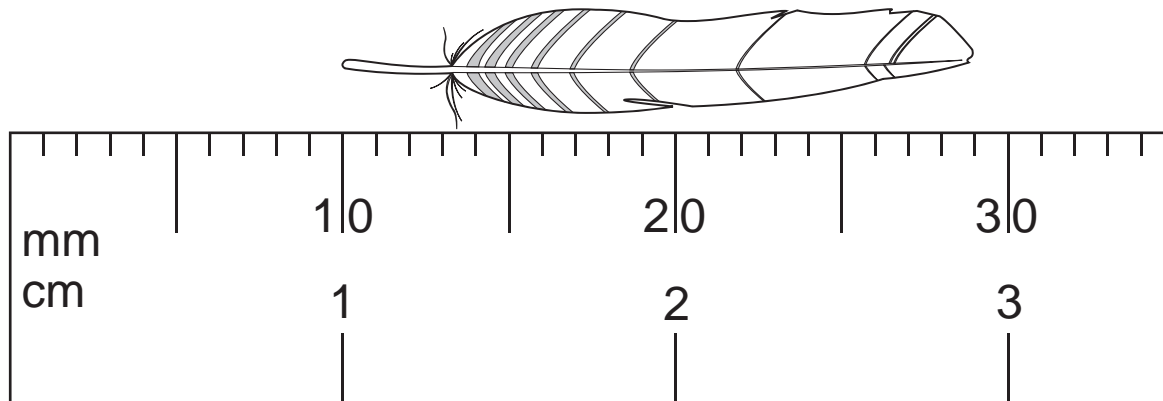

What is the length of the feather?

- A 19 mm            B 29 mm            C 19 cm            D 29 cm

- 3 Water waves can be used to show reflection, refraction and diffraction.

For each of these, which row shows whether or not the speed of the water waves changes?

	reflection	refraction	diffraction
<b>A</b>	no	no	yes
<b>B</b>	no	yes	no
<b>C</b>	yes	no	no
<b>D</b>	yes	yes	yes

- 4 The diagram shows a balance being used to find the weight of a baby. The weight of the basket can be ignored.

At equilibrium, the pivot is nearer to the weight  $W$  than to the baby.

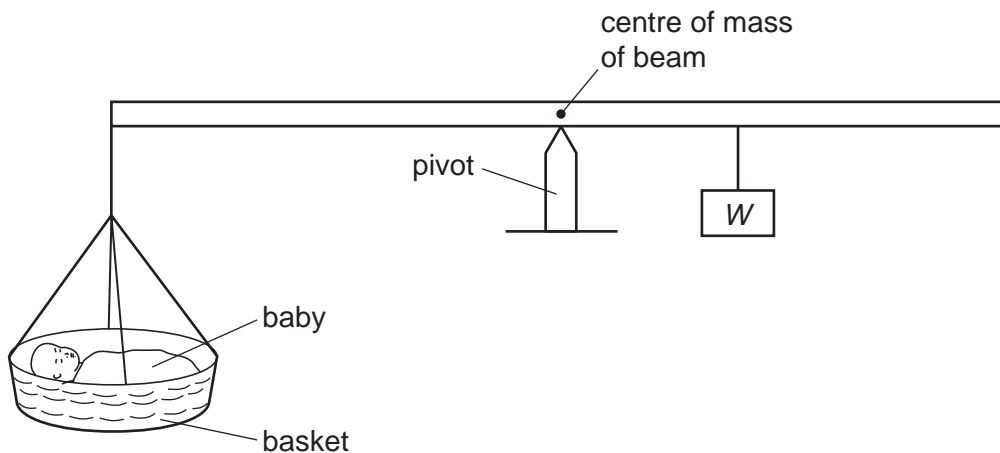

What is the weight of the baby?

- A** less than  $W$
  - B** more than  $W$
  - C**  $W$
  - D** impossible to tell
- 5 Which statement about mass and weight is correct?
- A** Mass and weight are both forces.
  - B** Neither mass nor weight is a force.
  - C** Only mass is a force.
  - D** Only weight is a force.

- 6 An object moves initially with constant speed and then with constant acceleration.

Which graph shows this motion?

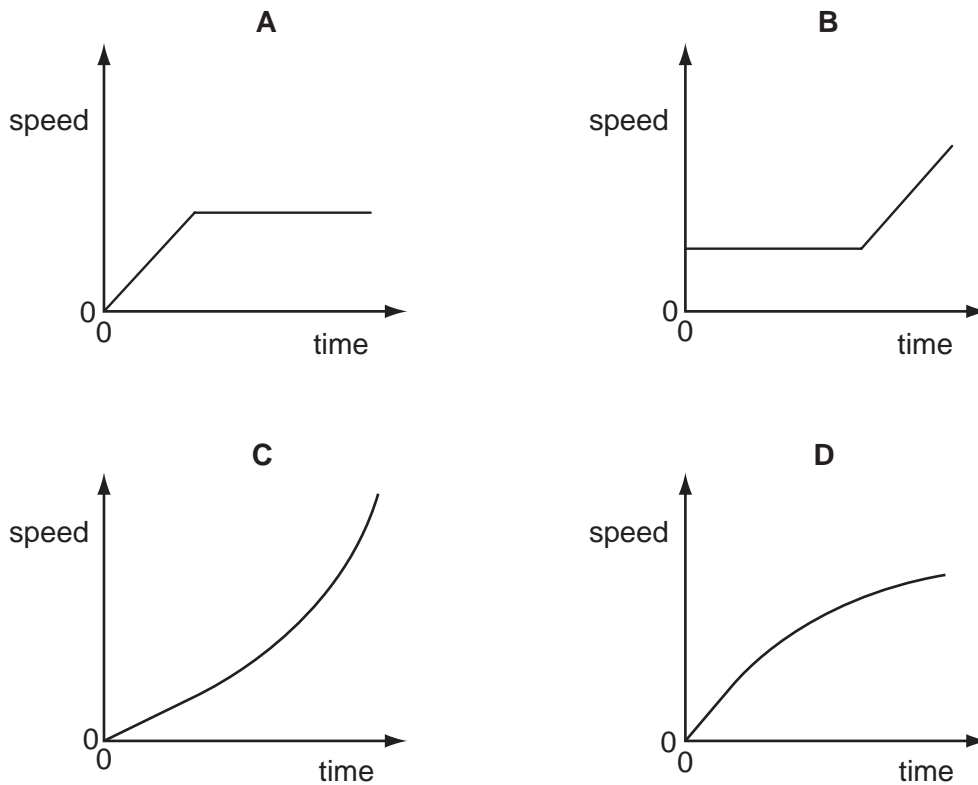

- 7 A cube of side 2.0 cm is placed on a balance.

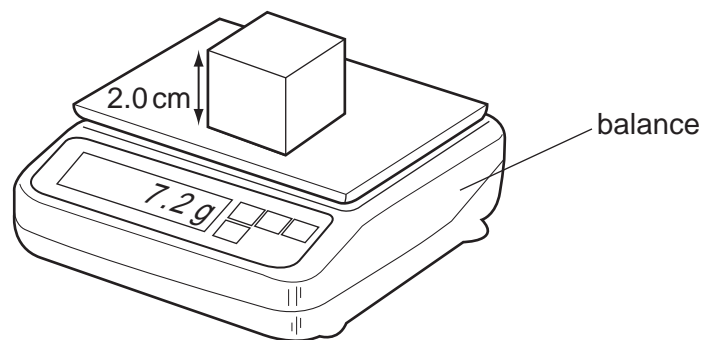

What is the density of the cube?

- A**  $0.90\text{ g/cm}^3$     **B**  $1.2\text{ g/cm}^3$     **C**  $1.8\text{ g/cm}^3$     **D**  $3.6\text{ g/cm}^3$
- 8 An ice cube at a temperature of  $0^\circ\text{C}$  is put into a drink at a temperature of  $10^\circ\text{C}$ .  
After a short time, some of the ice has melted and the drink has cooled to a temperature of  $8^\circ\text{C}$ .  
What is the temperature of the remaining ice?
- A**  $0^\circ\text{C}$     **B**  $2^\circ\text{C}$     **C**  $4^\circ\text{C}$     **D**  $8^\circ\text{C}$

9 The diagram shows a thermometer calibrated in degrees Celsius.

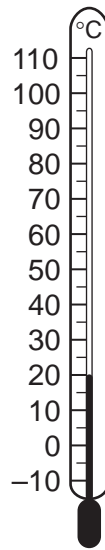

What are the values of the lower fixed point and of the upper fixed point on the Celsius scale?

	lower fixed point/ $^{\circ}\text{C}$	upper fixed point/ $^{\circ}\text{C}$
<b>A</b>	-10	110
<b>B</b>	0	20
<b>C</b>	0	100
<b>D</b>	20	100

10 An experiment is set up to find out which metal is the best conductor of heat.

Balls are stuck with wax to rods made from different metals, as shown in diagram 1.

The rods are heated at one end. Some of the balls fall off, leaving some as shown in diagram 2.

Which labelled metal is the best conductor of heat?

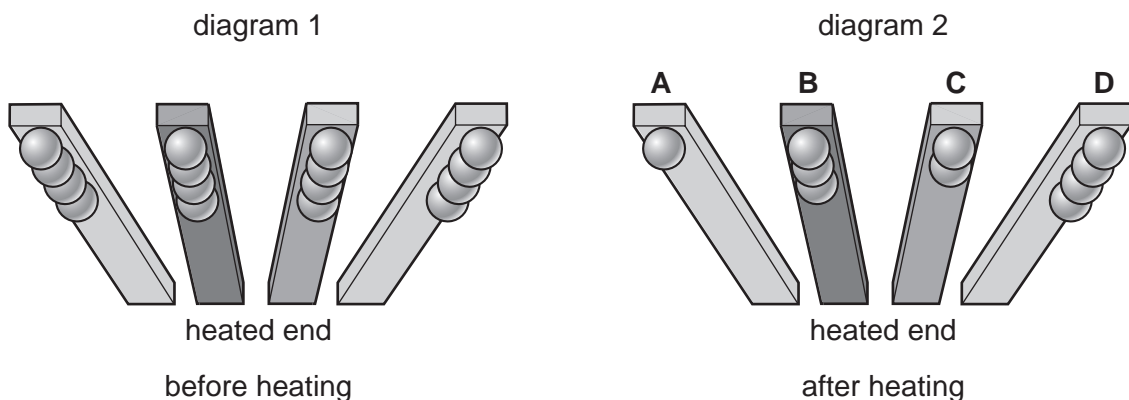

- 11 Objects with different masses are hung on a spring. The diagram shows how much the spring stretches.

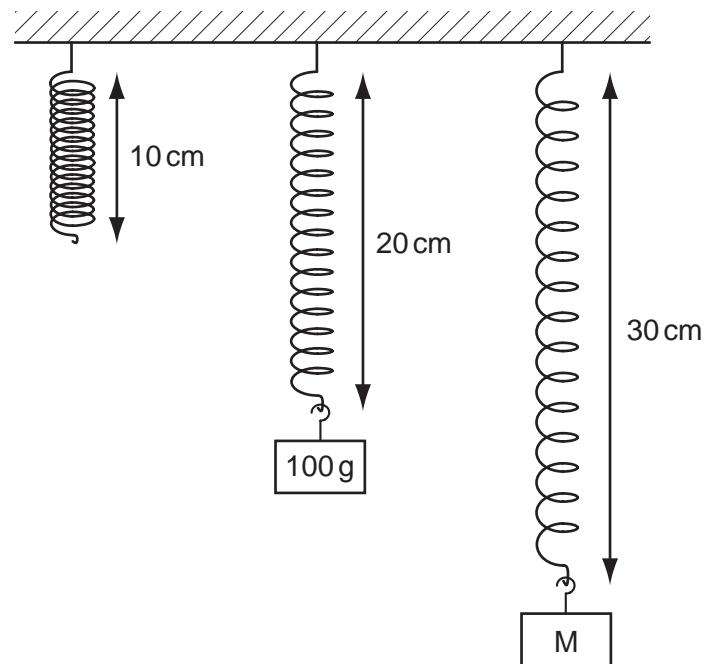

The extension of the spring is directly proportional to the mass hung on it.

What is the mass of object M?

- A** 110 g      **B** 150 g      **C** 200 g      **D** 300 g
- 12 When a liquid evaporates, some molecules escape from it and its temperature changes.

From where do the molecules escape and what is the effect on the temperature of the liquid?

	molecules escape from	temperature of liquid
<b>A</b>	all parts of the liquid	decreases
<b>B</b>	all parts of the liquid	increases
<b>C</b>	only the liquid surface	decreases
<b>D</b>	only the liquid surface	increases

13 A sealed gas cylinder is left outside on a hot, sunny day.

What happens to the average speed of the molecules and to the pressure of the gas in the cylinder as the temperature rises?

	average speed of the gas molecules	gas pressure
<b>A</b>	falls	falls
<b>B</b>	falls	rises
<b>C</b>	rises	falls
<b>D</b>	rises	rises

14 The diagram shows two mercury barometers.

Barometer 1 is measuring atmospheric pressure on day 1.

Barometer 2 is measuring atmospheric pressure on day 2.

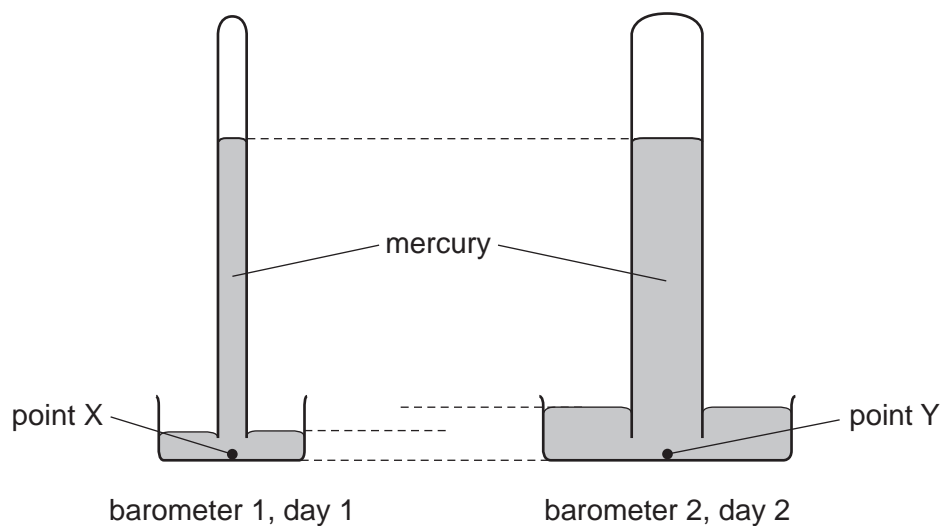

Which statement is true?

- A** The atmospheric pressure on day 1 is less than the atmospheric pressure on day 2.
- B** The atmospheric pressure on day 1 is the same as the atmospheric pressure on day 2.
- C** The pressure at point X is less than the pressure at point Y.
- D** The pressure at point X is the same as the pressure at point Y.

15 Which row gives an example of the stated form of energy?

	form of energy	example
<b>A</b>	gravitational	the energy due to the movement of a train along a level track
<b>B</b>	internal	the energy due to the flow of cathode rays in a cathode-ray tube
<b>C</b>	kinetic	the energy due to the position of a swimmer standing on a high diving board
<b>D</b>	strain	the energy due to the compression of springs in a car seat

16 A brick with flat, rectangular sides rests on a table.

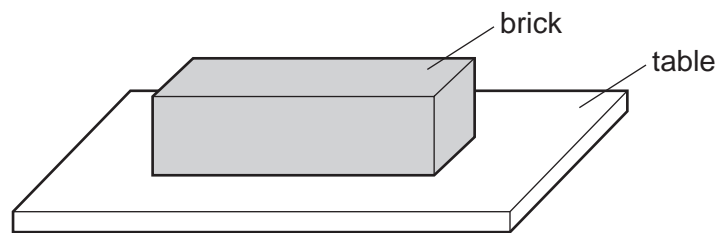

The brick is now turned so that it rests on the table on its smallest face.

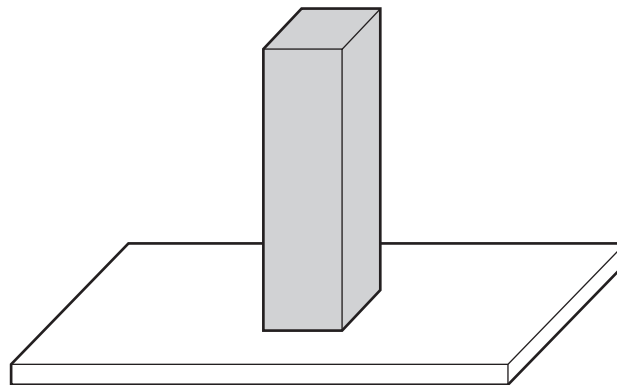

How has this affected the force and the pressure exerted by the brick on the table?

	force	pressure
<b>A</b>	increased	increased
<b>B</b>	increased	unchanged
<b>C</b>	unchanged	increased
<b>D</b>	unchanged	unchanged



- 17 Two farmers use an electrically powered elevator to lift bales of hay. All the bales of hay have the same mass.

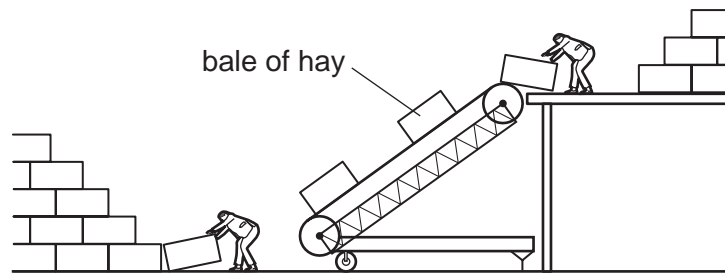

As sunset approaches, they increase the speed of the motor so that more bales are lifted up in a given time.

How does this affect the work done in lifting each bale and the useful output power of the motor?

	work done in lifting each bale	useful output power of the motor
<b>A</b>	increases	decreases
<b>B</b>	increases	increases
<b>C</b>	no change	decreases
<b>D</b>	no change	increases

- 18 Which energy resource is used to generate electricity by first boiling water?

- A** hydroelectric
- B** nuclear fission
- C** tides
- D** waves

- 19 A thin converging lens is used to produce, on a screen, a focused image of a candle.

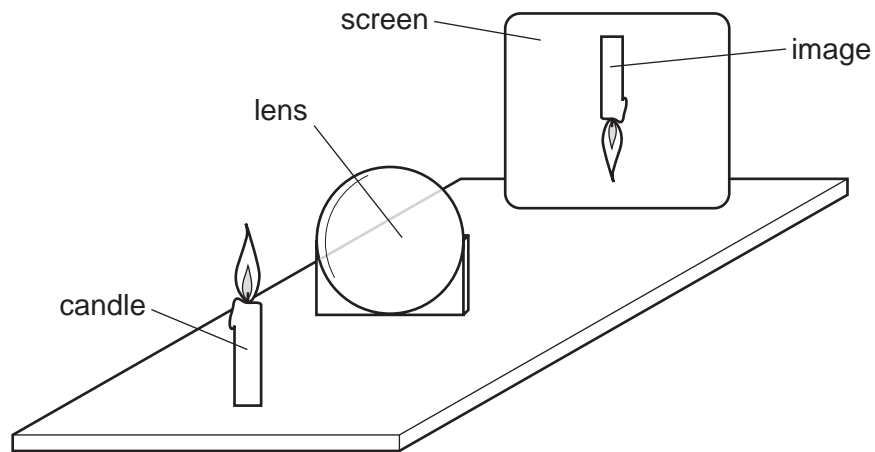

Various focused images are produced on the screen by moving the lens and the screen backwards and forwards.

Which statement is **always** correct?

- A The image is at the principal focus (focal point) of the lens.
  - B The image is bigger than the object.
  - C The image is closer to the lens than the object is.
  - D The image is inverted.
- 20 Food is kept in a cool-box which uses two ice packs to keep it cool.

Where should the ice packs be placed to keep all the food as cool as possible?

- A both at the bottom of the box
  - B both at the top of the box
  - C one at the front and one at the back of the box
  - D one on the left and one on the right of the box
- 21 Sound travels by wave motion.

Which property of waves causes echoes?

- A diffraction
- B dispersion
- C reflection
- D refraction

- 22 A student listens to a machine that makes sounds of different frequencies. He can only hear one of the sounds.

Which frequency of sound is the student able to hear?

- A 2 Hz                      B 10 Hz                      C 2 kHz                      D 30 kHz

- 23 The diagram shows the dispersion of white light by a glass prism.

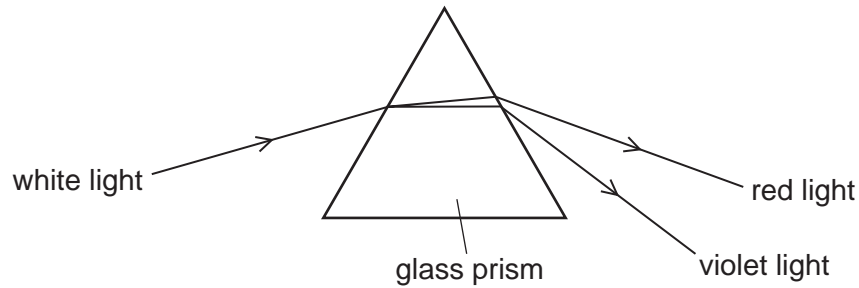

Why does dispersion occur when white light enters the glass?

- A The frequency of red light decreases more than that of violet light.  
 B The frequency of violet light decreases more than that of red light.  
 C The speed of red light decreases more than that of violet light.  
 D The speed of violet light decreases more than that of red light.
- 24 A vertical stick is dipped up and down in water at P.

In two seconds, three wave crests are produced on the surface of the water.

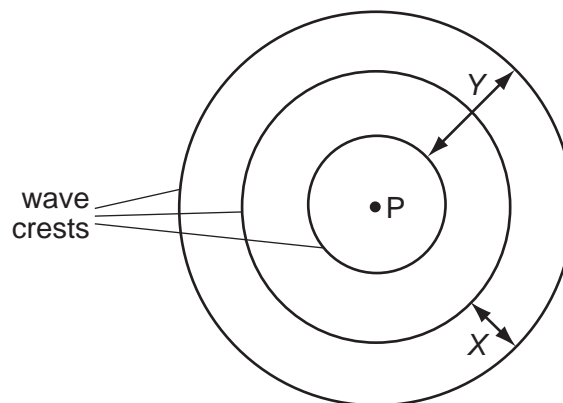

Which statement is correct?

- A Distance X is the amplitude of the waves.  
 B Distance Y is the wavelength of the waves.  
 C Each circle represents a wavefront.  
 D The frequency of the waves is 3 Hz.

- 25 An ammeter and an  $18\ \Omega$  resistor are connected in series with a battery. The reading on the ammeter is  $0.50\ \text{A}$ . The resistance of the battery and the ammeter can be ignored.

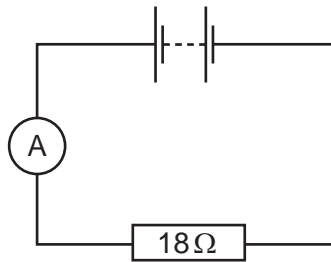

What is the electromotive force (e.m.f.) of the battery?

- A 9.0 N      B 9.0 V      C 36 N      D 36 V
- 26 In two separate experiments, a magnet is brought near to an unmagnetised iron bar. This causes the bar to become magnetised.

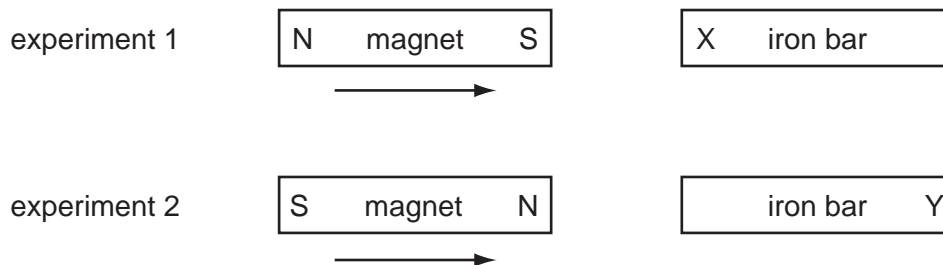

Which magnetic poles are induced at X and at Y?

	pole induced at X	pole induced at Y
<b>A</b>	N	N
<b>B</b>	N	S
<b>C</b>	S	N
<b>D</b>	S	S

- 27 Which circuit includes a capacitor and what does the capacitor do in this circuit?

	circuit	what the capacitor does
<b>A</b>	potential divider	stores current
<b>B</b>	potential divider	stores energy
<b>C</b>	time delay	stores current
<b>D</b>	time delay	stores energy

- 28 Which test could be used to find which end of a magnet is the north pole?
- A putting it near a compass needle
  - B putting it near a ferrous metal
  - C putting it near a non-ferrous metal
  - D putting it near a steel spoon
- 29 The diagram shows a thermistor in a potential divider. A voltmeter is connected across the thermistor.

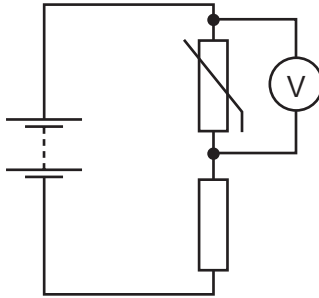

The graph shows how the resistance of the thermistor changes with temperature.

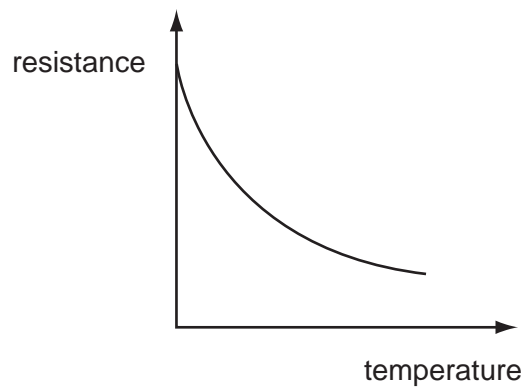

As the thermistor becomes warmer, what happens to its resistance and what happens to the reading on the voltmeter?

	resistance	voltmeter reading
<b>A</b>	decreases	decreases
<b>B</b>	decreases	increases
<b>C</b>	increases	decreases
<b>D</b>	increases	increases

30 A polythene rod repels an inflated balloon hanging from a nylon thread.

What charges must the rod and the balloon carry?

- A The rod and the balloon carry opposite charges.
- B The rod and the balloon carry like charges.
- C The rod is charged but the balloon is not.
- D The balloon is charged but the rod is not.

31 A student sets up the circuit shown. The switch is open (off).

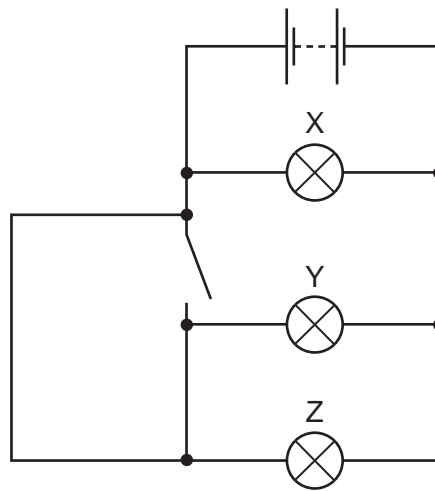

Which lamps are on and which lamps are off?

	lamp X	lamp Y	lamp Z
<b>A</b>	off	off	off
<b>B</b>	on	off	off
<b>C</b>	on	off	on
<b>D</b>	on	on	on

- 32 A magnet is suspended from a spring so that it can move freely inside a coil. The coil is connected to a sensitive centre-zero ammeter.

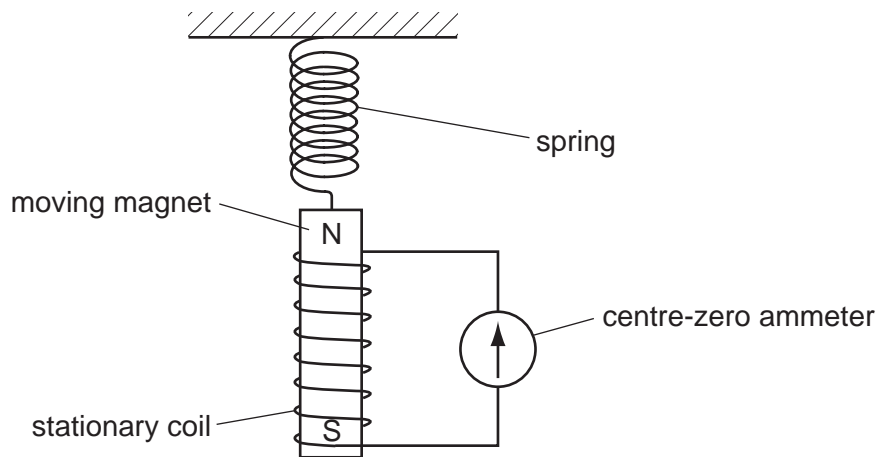

What does the ammeter show when the magnet repeatedly moves slowly up and down?

- A** a reading constantly changing from left to right and right to left  
**B** a steady reading to the left  
**C** a steady reading to the right  
**D** a steady reading of zero
- 33 Which graph shows how the output voltage varies with time for a simple a.c. generator?

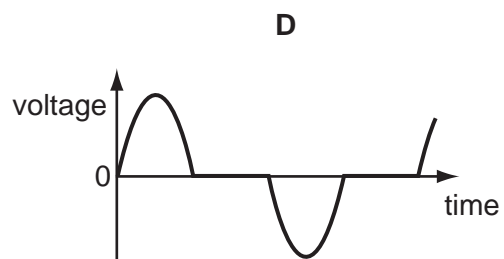
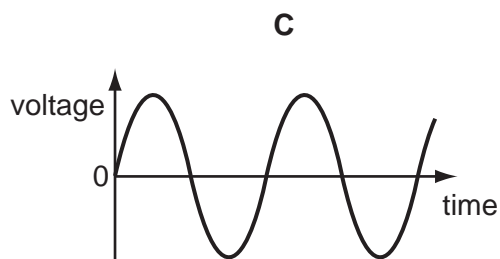
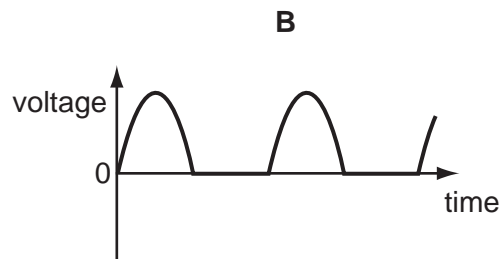
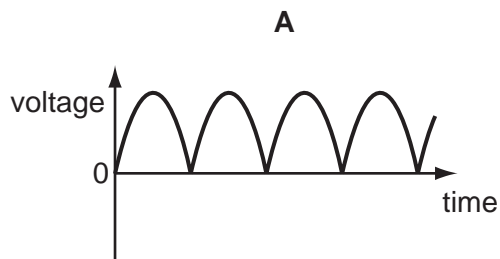

34 The diagram shows a simple step-down transformer used to decrease a voltage.

Which part is the primary coil?

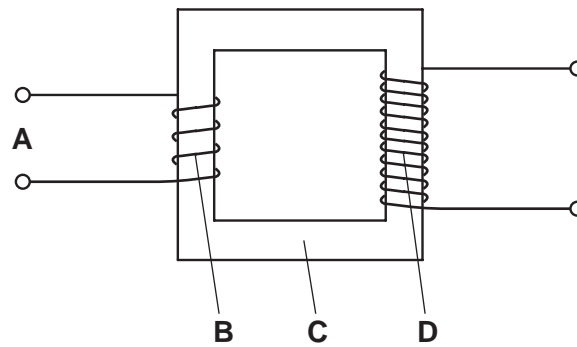

35 In this circuit, a component at X automatically protects the wiring from overheating if there is a fault.

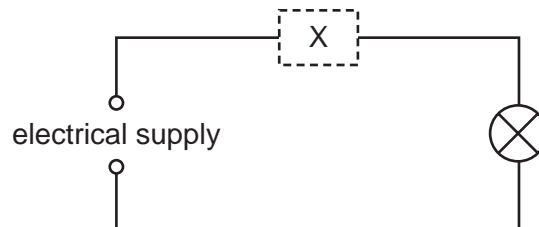

Which components are suitable to use at X?

- A a circuit-breaker, a fuse or a switch
- B only a circuit-breaker or a fuse
- C only a circuit-breaker or a switch
- D only a fuse



36 An atom of the element lithium has a nucleon number of 7 and a proton number of 3.

Which diagram represents a neutral atom of lithium?

**A**

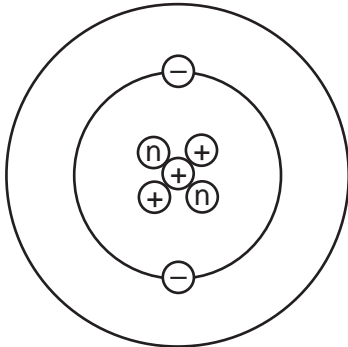

**B**

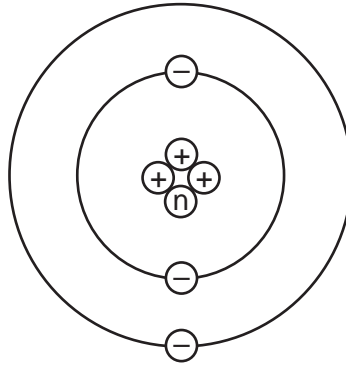

key

Ⓝ = a neutron

⊕ = a proton

⊖ = an electron

(not to scale)

**C**

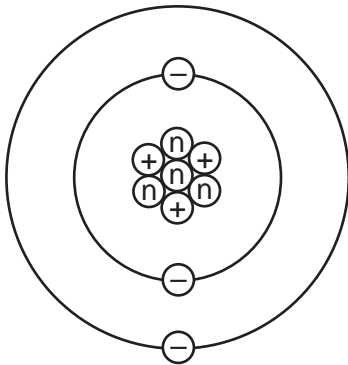

**D**

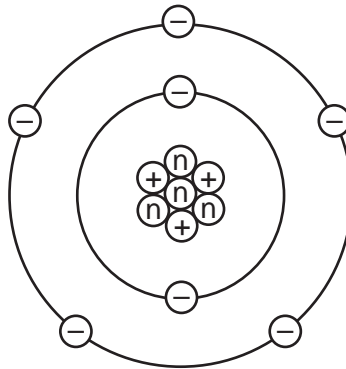

37 A powder contains 400 mg of a radioactive material that emits  $\alpha$ -particles.

The half-life of the material is 5 days.

What mass of that material remains after 10 days?

- A** 0 mg            **B** 40 mg            **C** 100 mg            **D** 200 mg

38 Which row shows the relative ionising effects and penetrating abilities of  $\alpha$ -particles and  $\beta$ -particles?

	ionising effect	penetrating ability
<b>A</b>	$\alpha$ greater than $\beta$	$\alpha$ greater than $\beta$
<b>B</b>	$\alpha$ greater than $\beta$	$\alpha$ less than $\beta$
<b>C</b>	$\alpha$ less than $\beta$	$\alpha$ greater than $\beta$
<b>D</b>	$\alpha$ less than $\beta$	$\alpha$ less than $\beta$

39 A beam of cathode rays passes between two parallel metal plates connected to a high-voltage d.c. power supply.

Which path does the beam follow?

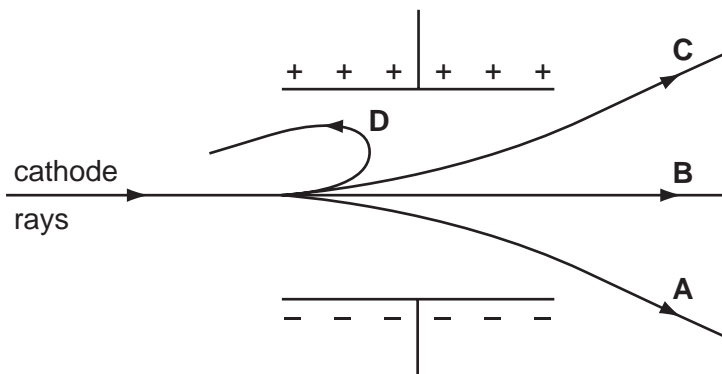

40 The diagram shows a cathode-ray tube.

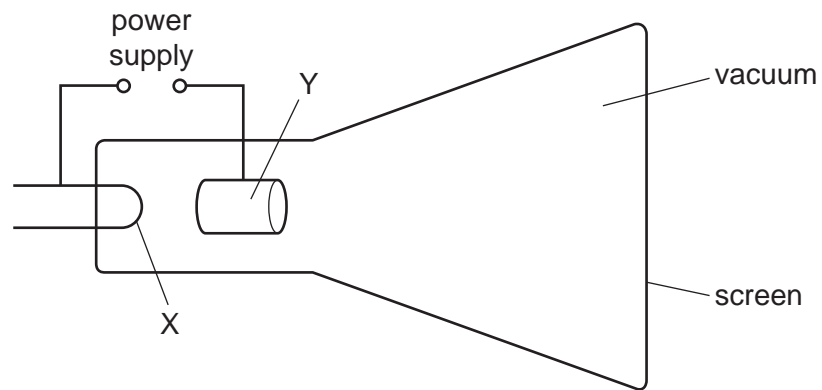

What are the correct labels for X and for Y?

	X	Y
<b>A</b>	negative anode	positive cathode
<b>B</b>	negative cathode	positive anode
<b>C</b>	positive anode	negative cathode
<b>D</b>	positive cathode	negative anode

**BLANK PAGE**

---

Permission to reproduce items where third-party owned material protected by copyright is included has been sought and cleared where possible. Every reasonable effort has been made by the publisher (UCLES) to trace copyright holders, but if any items requiring clearance have unwittingly been included, the publisher will be pleased to make amends at the earliest possible opportunity.

University of Cambridge International Examinations is part of the Cambridge Assessment Group. Cambridge Assessment is the brand name of University of Cambridge Local Examinations Syndicate (UCLES), which is itself a department of the University of Cambridge.