



**Cambridge International Examinations**  
Cambridge International General Certificate of Secondary Education

**CHEMISTRY**

**0620/23**

Paper 2 Multiple Choice (Extended)

**May/June 2016**

**45 Minutes**

Additional Materials:      Multiple Choice Answer Sheet  
   Soft clean eraser  
   Soft pencil (type B or HB is recommended)

\* 0 8 7 2 6 4 5 5 7 6 \*

**READ THESE INSTRUCTIONS FIRST**

Write in soft pencil.  
Do not use staples, paper clips, glue or correction fluid.  
Write your name, Centre number and candidate number on the Answer Sheet in the spaces provided unless this has been done for you.  
**DO NOT WRITE IN ANY BARCODES.**

There are **forty** questions on this paper. Answer **all** questions. For each question there are four possible answers **A, B, C** and **D**.  
Choose the **one** you consider correct and record your choice in **soft pencil** on the separate Answer Sheet.

**Read the instructions on the Answer Sheet very carefully.**

Each correct answer will score one mark. A mark will not be deducted for a wrong answer.  
Any rough working should be done in this booklet.  
A copy of the Periodic Table is printed on page 20.  
Electronic calculators may be used.

The syllabus is approved for use in England, Wales and Northern Ireland as a Cambridge International Level 1/Level 2 Certificate.

This document consists of **17** printed pages and **3** blank pages.

- 1 The diagram shows an experiment to demonstrate diffusion.

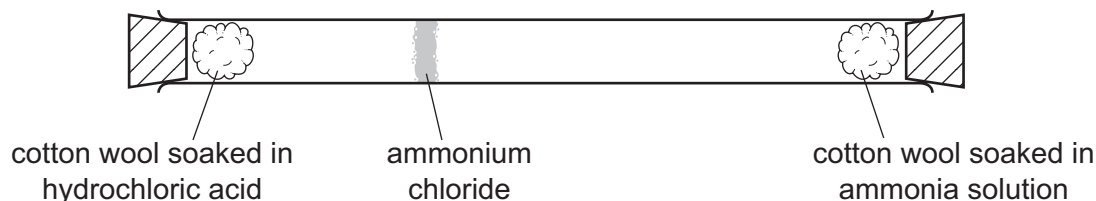

Which statement explains why the ring of ammonium chloride appears as shown?

- A** Ammonia solution only produces a gas which moves until it meets the hydrochloric acid.
- B** Both solutions produce a gas, but ammonia moves quicker than hydrogen chloride because it is lighter.
- C** Hydrochloric acid produces hydrogen chloride which stays at one end of the tube until the ammonia reaches it.
- D** The two solutions run along the tube until they meet.
- 2 Chromatography experiments are carried out on four substances, P, Q, R and S.

The same solvent is used in each experiment.

The resulting chromatograms are shown below.

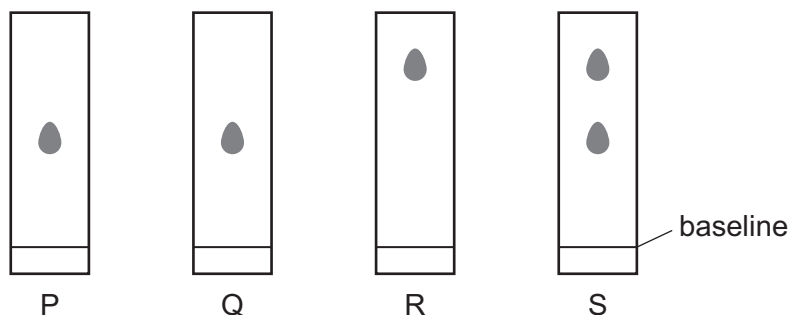

Which statement is **not** correct?

- A** P and Q are pure substances.
- B** P and R are different substances.
- C** R and S are pure substances.
- D** S is a mixture of substances.

- 3 The diagram shows the apparatus used to separate the different components of a mixture by chromatography.

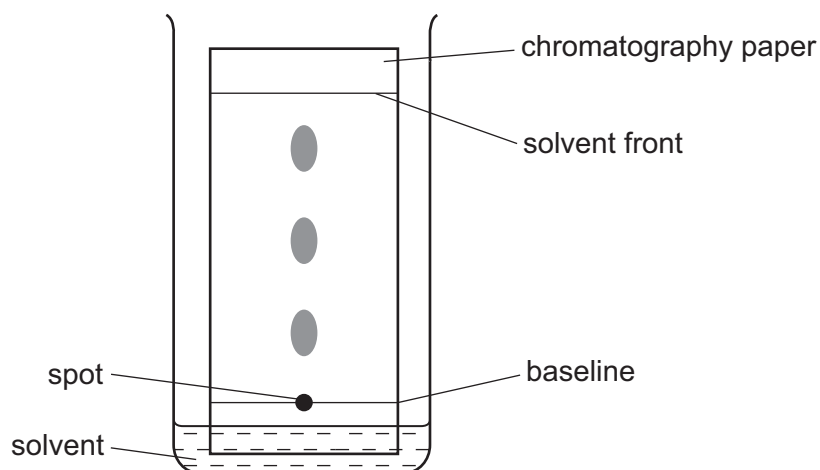

Which statement about this experiment is correct?

- A** A locating agent is used to find the position of the solvent front.
- B** The components to be separated must be soluble in the solvent.
- C** The baseline on which the spot of the mixture is placed is drawn in ink.
- D** The  $R_f$  value is calculated by  $\frac{\text{the distance travelled by the solvent front}}{\text{the distance travelled by the component}}$
- 4 Which statements about isotopes of the same element are correct?
- 1 They are atoms which have the same chemical properties because they have the same number of electrons in their outer shell.
  - 2 They are atoms which have the same number of electrons and neutrons but different numbers of protons.
  - 3 They are atoms which have the same number of electrons and protons but different numbers of neutrons.
- A** 1 and 2      **B** 1 and 3      **C** 2 only      **D** 3 only

- 5 The table shows the electronic structure of four atoms.

atom	electronic structure
W	2,8,1
X	2,8,4
Y	2,8,7
Z	2,8,8

Which two atoms combine to form a covalent compound?

- A** W and X      **B** W and Y      **C** X and Y      **D** X and Z
- 6 Which statement describes the attractive forces between molecules (intermolecular forces)?
- A** They are strong covalent bonds which hold molecules together.  
**B** They are strong ionic bonds which hold molecules together.  
**C** They are weak forces formed between covalently-bonded molecules.  
**D** They are weak forces which hold ions together in a lattice.
- 7 Which substance exists as a lattice of positive ions in a 'sea of electrons'?
- A** liquid potassium chloride  
**B** solid graphite  
**C** solid magnesium  
**D** solid silicon(IV) oxide
- 8 Analysis of a compound formed between magnesium and nitrogen showed it contained 14.4 g of magnesium and 5.6 g of nitrogen.

What is the empirical formula of the compound?

- A** Mg<sub>2</sub>N<sub>3</sub>      **B** Mg<sub>3</sub>N<sub>2</sub>      **C** Mg<sub>4</sub>N<sub>6</sub>      **D** Mg<sub>6</sub>N<sub>4</sub>

- 9 An excess of zinc is added to 100 cm<sup>3</sup> of 1.0 mol/dm<sup>3</sup> hydrochloric acid.

The equation for the reaction is:

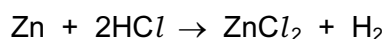

What is the maximum volume of hydrogen evolved at room temperature and pressure?

- A** 1.2 dm<sup>3</sup>      **B** 2.0 dm<sup>3</sup>      **C** 2.4 dm<sup>3</sup>      **D** 24 dm<sup>3</sup>

10 The diagram shows a method used to copper-plate a pan

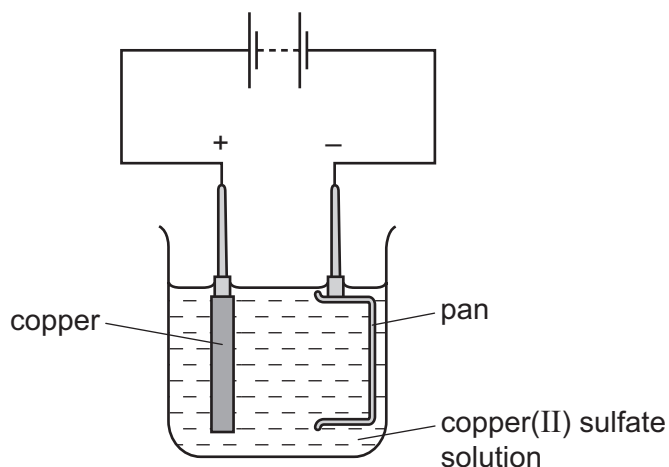

Which equation represents the reaction at the cathode?

- A  $\text{Cu}^{2+} + 2\text{e}^- \rightarrow \text{Cu}$
- B  $2\text{H}^+ + 2\text{e}^- \rightarrow \text{H}_2$
- C  $4\text{OH}^- \rightarrow \text{O}_2 + 2\text{H}_2\text{O} + 4\text{e}^-$
- D  $2\text{O}^{2-} \rightarrow \text{O}_2 + 4\text{e}^-$

11 The diagram shows some properties that substances may have.

To which labelled part of the diagram does  $^{235}\text{U}$  belong?

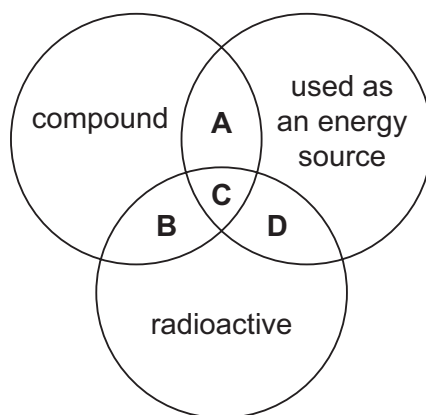

12 The diagram shows a simple cell.

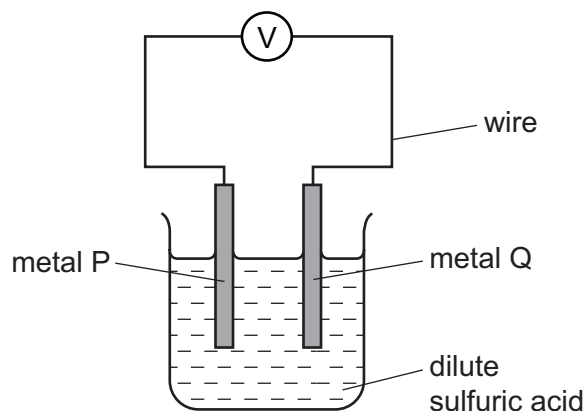

Which pair of metals produces the largest voltage?

	metal P	metal Q
<b>A</b>	iron	copper
<b>B</b>	magnesium	copper
<b>C</b>	magnesium	zinc
<b>D</b>	zinc	copper

13 Hydrazine,  $\text{N}_2\text{H}_4$ , decomposes as shown.

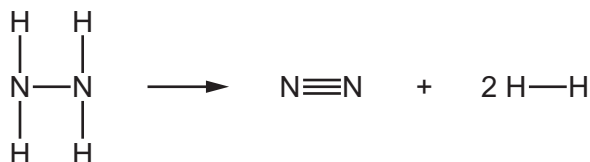

The energy change for this reaction is  $-95 \text{ kJ/mol}$ .

The table shows some bond energies involved.

bond	bond energy in $\text{kJ/mol}$
$\text{N} \equiv \text{N}$	945
$\text{N} - \text{H}$	391
$\text{H} - \text{H}$	436

What is the bond energy of the  $\text{N} - \text{N}$  bond?

- A** 158  $\text{kJ/mol}$     **B** 315  $\text{kJ/mol}$     **C** 348  $\text{kJ/mol}$     **D** 895  $\text{kJ/mol}$

14 A liquid X reacts with solid Y to form a gas.

Which two diagrams show suitable methods for investigating the rate (speed) of the reaction?

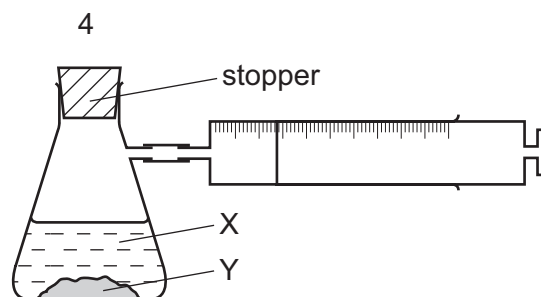
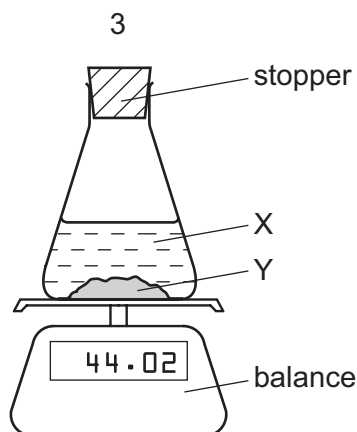
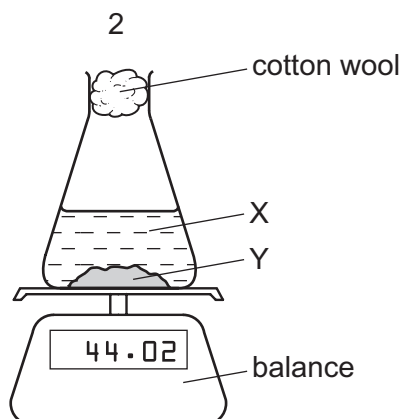
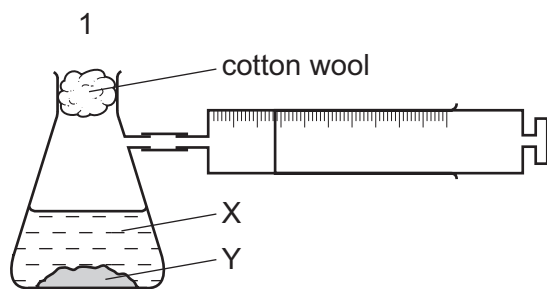

A 1 and 3

B 1 and 4

C 2 and 3

D 2 and 4

15 Which row explains why increasing temperature increases the rate of reaction?

	particles collide more often	particles collide with more energy
A	✓	✓
B	✓	x
C	x	✓
D	x	x

- 16** Methanol is manufactured by reacting carbon monoxide and hydrogen together in the presence of an aluminium oxide catalyst.

The equation for the reaction is shown.

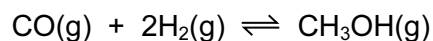

The reaction is a reversible reaction.

The forward reaction is exothermic.

Which change in conditions increases the yield of methanol?

- A** decreasing the concentration of the carbon monoxide
  - B** increasing the pressure
  - C** increasing the rate of the reaction
  - D** increasing the temperature
- 17** Which equation represents a reduction reaction?

- A**  $\text{Fe}^{2+} + \text{e}^- \rightarrow \text{Fe}^{3+}$
- B**  $\text{Fe}^{2+} \rightarrow \text{Fe}^{3+} + \text{e}^-$
- C**  $\text{Fe}^{3+} + \text{e}^- \rightarrow \text{Fe}^{2+}$
- D**  $\text{Fe}^{3+} \rightarrow \text{Fe}^{2+} + \text{e}^-$

- 18** Which statements are properties of an acid?

- 1 reacts with ammonium sulfate to form ammonia
- 2 turns red litmus blue

	1	2
<b>A</b>	✓	✓
<b>B</b>	✓	x
<b>C</b>	x	✓
<b>D</b>	x	x



19 Which row describes whether an amphoteric oxide reacts with acids and bases?

	reacts with acids	reacts with bases
<b>A</b>	no	no
<b>B</b>	no	yes
<b>C</b>	yes	no
<b>D</b>	yes	yes

20 Barium sulfate is an insoluble salt.

It can be made by reacting copper(II) sulfate solution with barium nitrate solution.

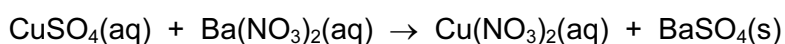

What is the correct order of steps to obtain a pure, dry sample of barium sulfate from the reaction mixture?

	step 1	step 2	step 3
<b>A</b>	filter	evaporate the filtrate to dryness	leave the solid formed to cool
<b>B</b>	filter	evaporate the filtrate to the point of crystallisation	leave the filtrate to cool
<b>C</b>	filter	leave the residue in a warm place to dry	wash the residue with water
<b>D</b>	filter	wash the residue with water	leave the residue in a warm place to dry

21 Where in the Periodic Table is the metallic character of the elements greatest?

	left or right side of a period	at the top or bottom of a group
<b>A</b>	left	bottom
<b>B</b>	left	top
<b>C</b>	right	bottom
<b>D</b>	right	top

22 Which statement about the elements in Group I is correct?

- A Hydrogen is evolved when they react with water.
- B Ions of Group I elements have a  $-1$  charge.
- C Sodium is more reactive than potassium.
- D Solid sodium is a poor electrical conductor.

23 Osmium is a transition element.

Which row gives the expected properties of osmium?

	melting point	density	compounds formed
A	high	high	coloured
B	high	high	white
C	high	low	white
D	low	high	coloured

24 Two statements about noble gases are given.

- 1 Noble gases are reactive, monatomic gases.
- 2 Noble gases all have full outer shells of electrons.

Which is correct?

- A Both statements are correct and statement 2 explains statement 1.
- B Both statements are correct but statement 2 does not explain statement 1.
- C Statement 1 is correct but statement 2 is incorrect.
- D Statement 2 is correct but statement 1 is incorrect.

25 Some properties of substance X are listed.

- It conducts electricity when molten.
- It has a high melting point.
- It burns in oxygen and the product dissolves in water to give a solution with pH 11.

What is X?

- A** a covalent compound  
**B** a macromolecule  
**C** a metal  
**D** an ionic compound

26 Four metals P, Q, R and S are added to separate aqueous solutions of their ions.

The results are shown.

metal	P <sup>2+</sup>	Q <sup>2+</sup>	R <sup>2+</sup>	S <sup>2+</sup>
P	x	x	✓	✓
Q	✓	x	✓	✓
R	x	x	x	x
S	x	x	✓	x

key

✓ = reaction occurs

x = reaction does not occur

What is the order of reactivity of the metals, most reactive first?

- A** Q → P → S → R  
**B** Q → S → P → R  
**C** R → P → S → Q  
**D** R → S → P → Q

27 Copper is a transition element used to make saucepans.

Which property is **not** correct for copper?

- A** good conductor of heat  
**B** insoluble in water  
**C** low melting point  
**D** malleable (can be hammered into shape)

28 Aluminium is extracted by electrolysis of a mixture of aluminium oxide and cryolite.

Which statement is **not** correct?

- A The electrodes are made from graphite.
- B The formula for aluminium oxide is  $Al_2O_3$ .
- C The purpose of the cryolite is to lower the melting point of the mixture.
- D The reaction taking place at the anode is  $Al^{3+} + 3e^- \rightarrow Al$ .

29 The diagram shows an experiment to investigate how paint affects the rusting of iron.

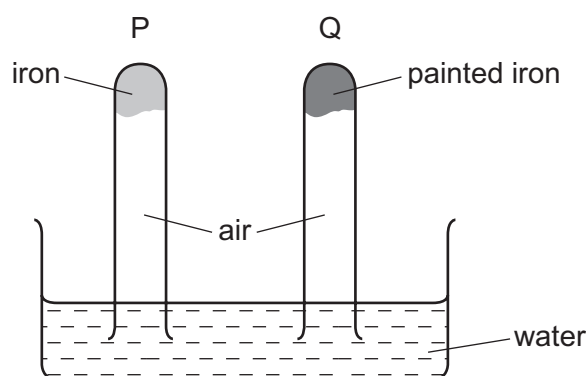

What happens to the water level in tubes P and Q?

	tube P	tube Q
<b>A</b>	falls	rises
<b>B</b>	no change	rises
<b>C</b>	rises	falls
<b>D</b>	rises	no change

- 30 A new planet has been discovered and its atmosphere has been analysed.

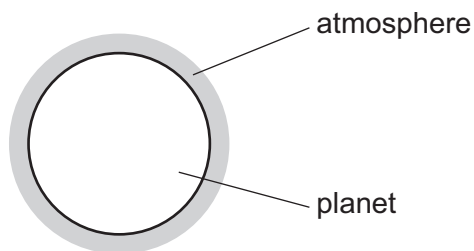

The table shows the composition of its atmosphere.

gas	percentage by volume
carbon dioxide	4
nitrogen	72
oxygen	24

Which gases are present in the atmosphere of the planet in a higher percentage than they are in the Earth's atmosphere?

- A carbon dioxide and oxygen
  - B carbon dioxide only
  - C nitrogen and oxygen
  - D nitrogen only
- 31 Catalytic converters are used to remove some gaseous pollutants from car exhaust fumes.

Which gas is removed from the fumes by oxidation?

- A carbon dioxide
  - B carbon monoxide
  - C nitrogen
  - D nitrogen oxide
- 32 Ammonia is produced by the Haber process.

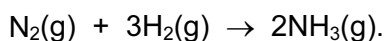

Which statement about the Haber process is **not** correct?

- A An iron catalyst is used to increase the rate of reaction.
- B The reaction is carried out at high temperature to increase the rate of reaction.
- C The reaction is carried out at low pressure to increase the yield of ammonia.
- D The reaction is reversible.

33 One step in the manufacture of sulfuric acid is the oxidation of sulfur dioxide to sulfur trioxide.

Which conditions are used for this step?

	temperature /°C	pressure /atmospheres	catalyst
<b>A</b>	450	1.5	iron
<b>B</b>	450	1.5	vanadium(V) oxide
<b>C</b>	450	200	iron
<b>D</b>	450	200	vanadium(V) oxide

34 Which process is used to make lime (calcium oxide) from limestone (calcium carbonate)?

- A** chromatography
- B** electrolysis
- C** fractional distillation
- D** thermal decomposition

35 The diagram shows the separation of petroleum into fractions.

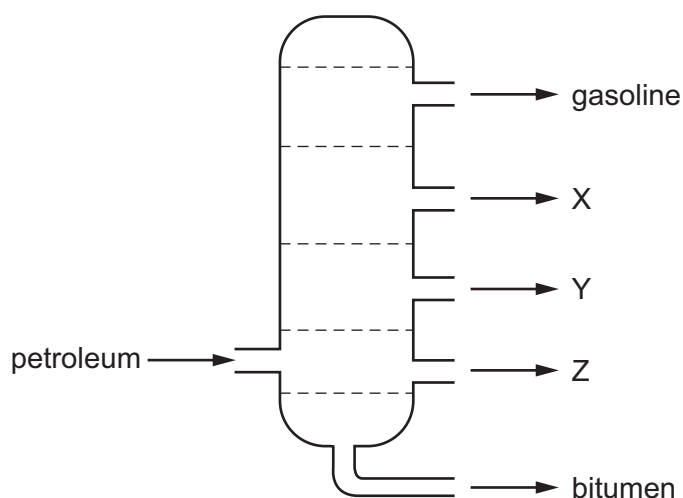

What could X, Y and Z represent?

	X	Y	Z
<b>A</b>	diesel oil	lubricating fraction	paraffin
<b>B</b>	lubricating fraction	diesel oil	paraffin
<b>C</b>	paraffin	lubricating fraction	diesel oil
<b>D</b>	paraffin	diesel oil	lubricating fraction

36 Which compound does **not** belong to the same homologous series as the other three compounds?

- A  $\text{CH}_3\text{OH}$       B  $\text{C}_2\text{H}_5\text{COOH}$       C  $\text{C}_2\text{H}_5\text{OH}$       D  $\text{C}_7\text{H}_{15}\text{OH}$

37 The structure of an alkene and the structure of an ester are shown.

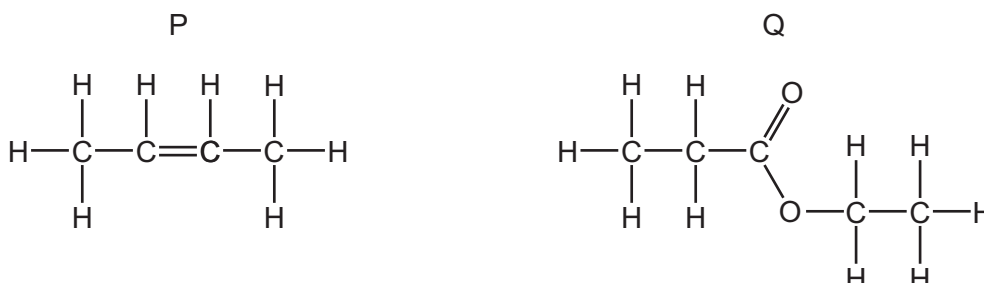

What are the names of P and Q?

	P	Q
<b>A</b>	but-1-ene	ethyl propanoate
<b>B</b>	but-1-ene	propyl ethanoate
<b>C</b>	but-2-ene	ethyl propanoate
<b>D</b>	but-2-ene	propyl ethanoate

38 What is an advantage of producing ethanol by fermentation of sugar compared to the catalytic addition of steam to ethene?

- A The alcohol produced is purer.  
 B The process is faster.  
 C The process uses high temperature.  
 D The process uses renewable raw materials.

39 A polymer has the formula shown.

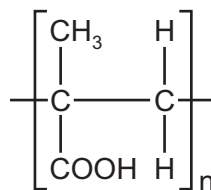

From which monomers can it be formed?

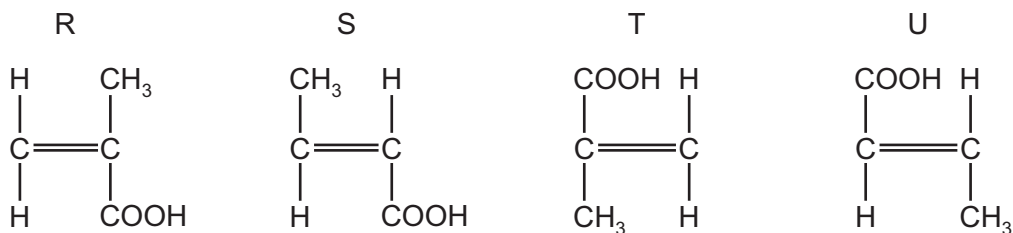

- A** R and S      **B** R and T      **C** S and U      **D** T and U

40 Which row shows a natural polymer with the same linkages as a synthetic polymer?

	natural polymer	synthetic polymer
<b>A</b>	complex carbohydrate	nylon
<b>B</b>	complex carbohydrate	<i>Terylene</i>
<b>C</b>	protein	nylon
<b>D</b>	protein	<i>Terylene</i>



**BLANK PAGE**

**BLANK PAGE**

**BLANK PAGE**

---

Permission to reproduce items where third-party owned material protected by copyright is included has been sought and cleared where possible. Every reasonable effort has been made by the publisher (UCLES) to trace copyright holders, but if any items requiring clearance have unwittingly been included, the publisher will be pleased to make amends at the earliest possible opportunity.

To avoid the issue of disclosure of answer-related information to candidates, all copyright acknowledgements are reproduced online in the Cambridge International Examinations Copyright Acknowledgements Booklet. This is produced for each series of examinations and is freely available to download at [www.cie.org.uk](http://www.cie.org.uk) after the live examination series.

Cambridge International Examinations is part of the Cambridge Assessment Group. Cambridge Assessment is the brand name of University of Cambridge Local Examinations Syndicate (UCLES), which is itself a department of the University of Cambridge.

## The Periodic Table of Elements

Group																	
I	II											III	IV	V	VI	VII	VIII
3 <b>Li</b> lithium 7	4 <b>Be</b> beryllium 9	<b>Key</b> atomic number atomic symbol name relative atomic mass										5 <b>B</b> boron 11	6 <b>C</b> carbon 12	7 <b>N</b> nitrogen 14	8 <b>O</b> oxygen 16	9 <b>F</b> fluorine 19	10 <b>Ne</b> neon 20
11 <b>Na</b> sodium 23	12 <b>Mg</b> magnesium 24											13 <b>Al</b> aluminium 27	14 <b>Si</b> silicon 28	15 <b>P</b> phosphorus 31	16 <b>S</b> sulfur 32	17 <b>Cl</b> chlorine 35.5	18 <b>Ar</b> argon 40
19 <b>K</b> potassium 39	20 <b>Ca</b> calcium 40	21 <b>Sc</b> scandium 45	22 <b>Ti</b> titanium 48	23 <b>V</b> vanadium 51	24 <b>Cr</b> chromium 52	25 <b>Mn</b> manganese 55	26 <b>Fe</b> iron 56	27 <b>Co</b> cobalt 59	28 <b>Ni</b> nickel 59	29 <b>Cu</b> copper 64	30 <b>Zn</b> zinc 65	31 <b>Ga</b> gallium 70	32 <b>Ge</b> germanium 73	33 <b>As</b> arsenic 75	34 <b>Se</b> selenium 79	35 <b>Br</b> bromine 80	36 <b>Kr</b> krypton 84
37 <b>Rb</b> rubidium 85	38 <b>Sr</b> strontium 88	39 <b>Y</b> yttrium 89	40 <b>Zr</b> zirconium 91	41 <b>Nb</b> niobium 93	42 <b>Mo</b> molybdenum 96	43 <b>Tc</b> technetium —	44 <b>Ru</b> ruthenium 101	45 <b>Rh</b> rhodium 103	46 <b>Pd</b> palladium 106	47 <b>Ag</b> silver 108	48 <b>Cd</b> cadmium 112	49 <b>In</b> indium 115	50 <b>Sn</b> tin 119	51 <b>Sb</b> antimony 122	52 <b>Te</b> tellurium 128	53 <b>I</b> iodine 127	54 <b>Xe</b> xenon 131
55 <b>Cs</b> caesium 133	56 <b>Ba</b> barium 137	57–71 lanthanoids	72 <b>Hf</b> hafnium 178	73 <b>Ta</b> tantalum 181	74 <b>W</b> tungsten 184	75 <b>Re</b> rhenium 186	76 <b>Os</b> osmium 190	77 <b>Ir</b> iridium 192	78 <b>Pt</b> platinum 195	79 <b>Au</b> gold 197	80 <b>Hg</b> mercury 201	81 <b>Tl</b> thallium 204	82 <b>Pb</b> lead 207	83 <b>Bi</b> bismuth 209	84 <b>Po</b> polonium —	85 <b>At</b> astatine —	86 <b>Rn</b> radon —
87 <b>Fr</b> francium —	88 <b>Ra</b> radium —	89–103 actinoids	104 <b>Rf</b> rutherfordium —	105 <b>Db</b> dubnium —	106 <b>Sg</b> seaborgium —	107 <b>Bh</b> bohrium —	108 <b>Hs</b> hassium —	109 <b>Mt</b> meitnerium —	110 <b>Ds</b> darmstadtium —	111 <b>Rg</b> roentgenium —	112 <b>Cn</b> copernicium —	114 <b>Fl</b> flerovium —	116 <b>Lv</b> livermorium —	—	—	—	—

57 <b>La</b> lanthanum 139	58 <b>Ce</b> cerium 140	59 <b>Pr</b> praseodymium 141	60 <b>Nd</b> neodymium 144	61 <b>Pm</b> promethium —	62 <b>Sm</b> samarium 150	63 <b>Eu</b> europium 152	64 <b>Gd</b> gadolinium 157	65 <b>Tb</b> terbium 159	66 <b>Dy</b> dysprosium 163	67 <b>Ho</b> holmium 165	68 <b>Er</b> erbium 167	69 <b>Tm</b> thulium 169	70 <b>Yb</b> ytterbium 173	71 <b>Lu</b> lutetium 175
89 <b>Ac</b> actinium —	90 <b>Th</b> thorium 232	91 <b>Pa</b> protactinium 231	92 <b>U</b> uranium 238	93 <b>Np</b> neptunium —	94 <b>Pu</b> plutonium —	95 <b>Am</b> americium —	96 <b>Cm</b> curium —	97 <b>Bk</b> berkelium —	98 <b>Cf</b> californium —	99 <b>Es</b> einsteinium —	100 <b>Fm</b> fermium —	101 <b>Md</b> mendelevium —	102 <b>No</b> nobelium —	103 <b>Lr</b> lawrencium —

lanthanoids

actinoids

The volume of one mole of any gas is 24 dm<sup>3</sup> at room temperature and pressure (r.t.p.)