

CAMBRIDGE INTERNATIONAL EXAMINATIONS

Cambridge International General Certificate of Secondary Education

MARK SCHEME for the May/June 2015 series

0478 COMPUTER SCIENCE

0478/11

Paper 1 (Written), maximum raw mark 75

This mark scheme is published as an aid to teachers and candidates, to indicate the requirements of the examination. It shows the basis on which Examiners were instructed to award marks. It does not indicate the details of the discussions that took place at an Examiners' meeting before marking began, which would have considered the acceptability of alternative answers.

Mark schemes should be read in conjunction with the question paper and the Principal Examiner Report for Teachers.

Cambridge will not enter into discussions about these mark schemes.

Cambridge is publishing the mark schemes for the May/June 2015 series for most Cambridge IGCSE[®], Cambridge International A and AS Level components and some Cambridge O Level components.

Page 2	Mark Scheme	Syllabus	Paper
	Cambridge IGCSE – May/June 2015	0478	11

1 (a) parallelany **one** from:

- 8 bits/1 byte/multiple bits sent at a time
- using many/multiple/8 wires/lines (1 mark)

serialany **one** from:

- one bit sent at a time
- over a single wire (1 mark) [2]

(b) parallel

- faster rate of data transmission (1 mark)

serialany **one** from:

- more accurate/fewer errors over a longer distance
- less expensive wiring
- less chance of data being skewed/out of synchronisation/order (1 mark) [2]

(c) parallelany **one** from:

- sending data from a computer to a printer
- internal data transfer (buses) (1 mark)

serial

- connect computer to a modem (1 mark) [2]

Page 3	Mark Scheme	Syllabus	Paper
	Cambridge IGCSE – May/June 2015	0478	11

- 2 (a) – universal serial bus
– description of USB [1]

(b) Any **two** from:

- devices are automatically detected and configured when initially attached
- impossible to connect device incorrectly/connector only fits one way
- has become the industry standard
- supports multiple data transmission speeds
- lots of support base for USB software developers
- supported by many operating systems
- backward compatible
- faster transmission compared to wireless

[2]

3 (a)

A	B	C	Working	X
0	0	0		1
0	0	1		0
0	1	0		0
0	1	1		0
1	0	0		0
1	0	1		1
1	1	0		1
1	1	1		1

] 1 mark

] 1 mark

] 1 mark

] 1 mark

[4]

Page 4	Mark Scheme	Syllabus	Paper
	Cambridge IGCSE – May/June 2015	0478	11

(b) 1 mark per dotted section

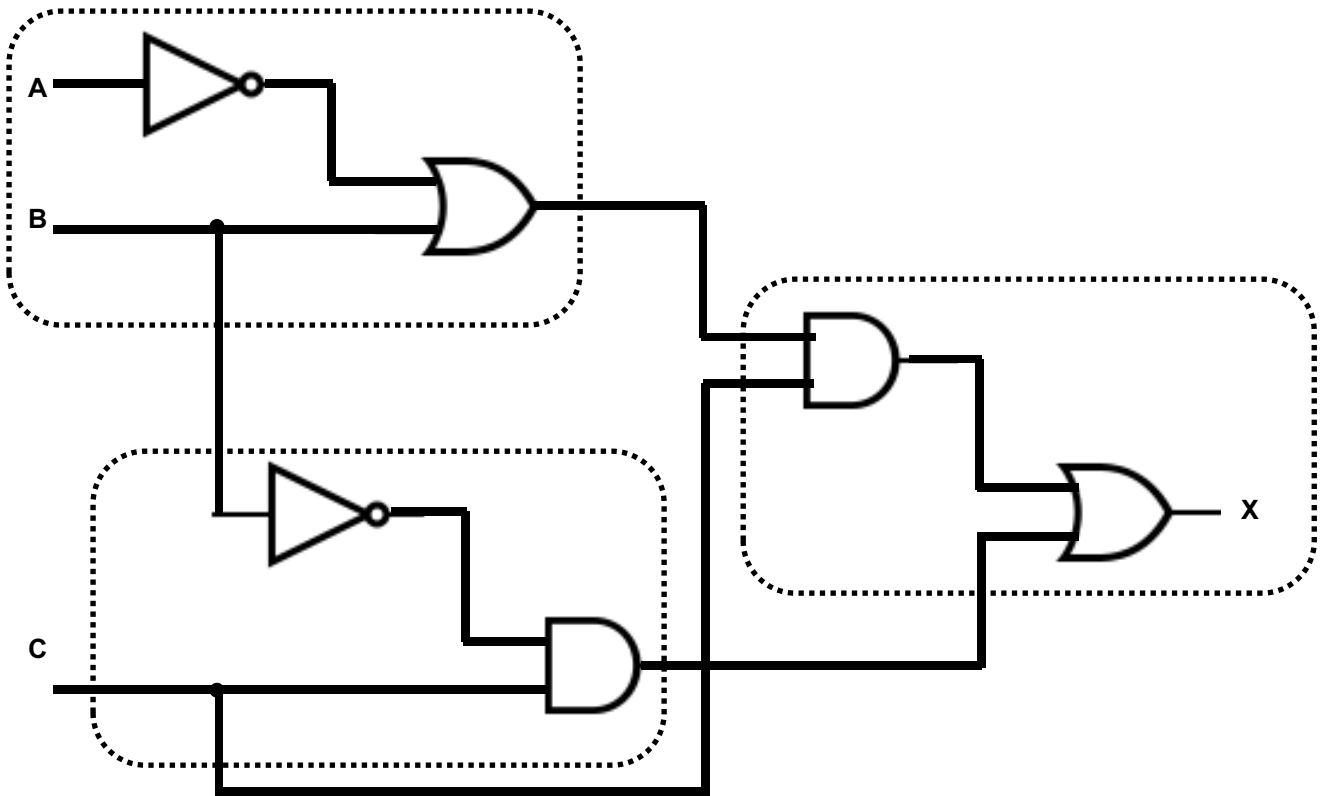

[3]

(c) X is 1 if:

(A is 1 OR B is 1)

(1 mark)

AND

(1 mark)

(B is 1 OR C is NOT 1)

(1 mark)

accept equivalent ways of writing this:

e.g. $(A \text{ OR } B = 1) \text{ AND } (B \text{ OR NOT } C = 1)$

e.g. $(A \text{ OR } B) \text{ AND } (B \text{ OR NOT } C)$

e.g. $(A + B) (B + \bar{C})$

[3]

Page 5	Mark Scheme	Syllabus	Paper
	Cambridge IGCSE – May/June 2015	0478	11

4 1 mark per correct word

1 protocol

2 web server name

3 file name

accept these three items in any order

HTML tags/text

firewall

proxy server

[6]

5 1 mark per device, 1 mark per category

Description of storage device	Name of storage device	Category of storage		
		Primary	Secondary	Off-line
optical media which uses one spiral track; red lasers are used to read and write data on the media surface; makes use of dual-layering technology to increase the storage capacity	DVD			✓
non-volatile memory chip; contents of the chip cannot be altered; it is often used to store the start-up routines in a computer (e.g. the BIOS)	ROM	✓		
optical media which uses concentric tracks to store the data; this allows read and write operations to be carried out at the same time	DVD-RAM	✓		(✓)
non-volatile memory device that uses NAND flash memories (which consist of millions of transistors wired in series on single circuit boards)	Solid State Drive/memory (SSD)		✓	
	(SD/XD card) (USB storage device)			(✓)
optical media that uses blue laser technology to read and write data on the media surface; it uses a single 1.1 mm polycarbonate disc	Blue-ray			✓

[10]

Page 6	Mark Scheme	Syllabus	Paper
	Cambridge IGCSE – May/June 2015	0478	11

6 (a) virus

any **two** from:

- program/software that replicates/copies itself
- can delete or alter files/data stored on a computer
- can make the computer “crash”/run slow

pharming

any **two** from:

- malicious code/software installed on a user’s hard drive/actual web server
- this code redirects user to a fake website (without their knowledge)
- to obtain personal/financial information/data

phishing

any **two** from:

- legitimate-looking emails sent to a user
- as soon as recipient opens/clicks on link in the email/attachment ...
- ... the user is directed to a fake website (without their knowledge)
- To obtain personal/financial information/data

[6]

(b) (i) Any two from:

- spyware/key logging software can only pick up key presses
- using mouse/touchscreen means no key presses to log
- the numbers on the key pad are in random/non-standard format, which makes it more difficult to interpret

[2]

Page 7	Mark Scheme	Syllabus	Paper
	Cambridge IGCSE – May/June 2015	0478	11

(ii) 1 mark for name and 1 mark for description

any **one** from:

chip and PIN reader

- only the user and the bank know which codes can be generated

request user name

- additional security together with password/PIN

anti-virus

- removes/warns of a potential virus threat which can't be passed on to customers

firewall

- (helps) to protect bank computers from virus threats and hacking

encryption

- protects customer data by making any hacked information unreadable

security protocol

- governs the secure transmission of data

Biometric

- to recognise user through the use of, e.g. facial/retina/finger print

Alerts

- users IP/MAC address is registered and user is alerted through, e.g. SMS if account is accessed through an unregistered address

[2]

7 (a)

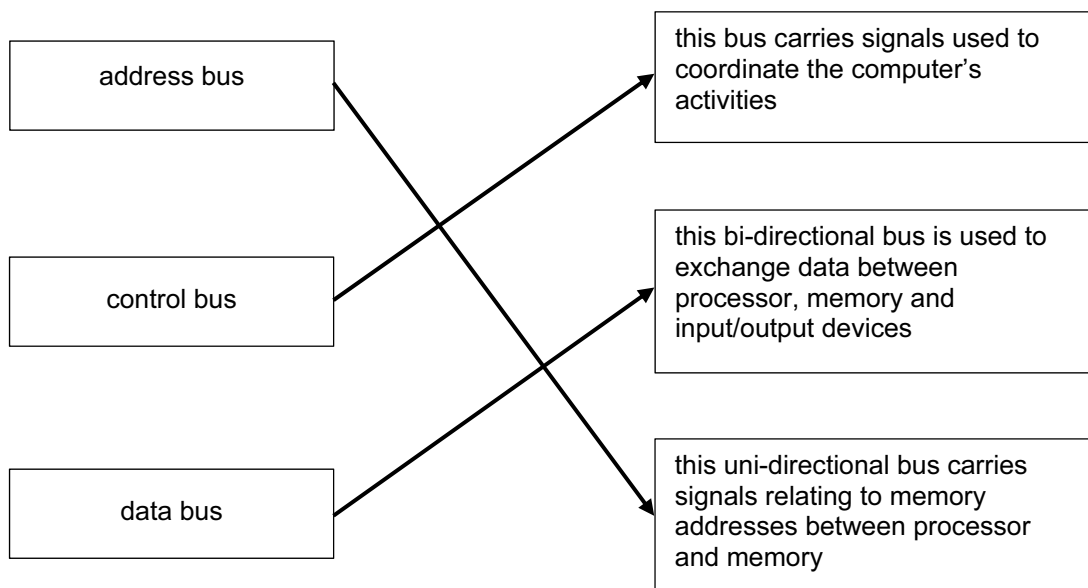

2/3 matches – 2 marks

1 match – 1 mark

[2]

Page 8	Mark Scheme	Syllabus	Paper
	Cambridge IGCSE – May/June 2015	0478	11

(b)

description of stage	sequence number
the instruction is then copied from the memory location contained in the MAR (memory address register) and is placed in the MDR (memory data register)	3
the instruction is finally decoded and is then executed	7
<i>the PC (program counter) contains the address of the next instruction to be fetched</i>	(1)
the entire instruction is then copied from the MDR (memory data register) and placed in the CIR (current instruction register)	4
the address contained in the PC (program counter) is copied to the MAR (memory address register) via the address bus	2
the address part of the instruction is placed in the MAR (memory address register)	6
the value in the PC (program counter) is then incremented so that it points to the next instruction to be fetched	5*

The incrementation of the program counter can appear at any stage after 2. All other stages must be in the correct given order.

[6]

8 (a) hours: 18

minutes: 53

[2]

(b)

hours ("C")

0	0	0	0	0	1	1	1
---	---	---	---	---	---	---	---

:

minutes ("D")

0	0	0	1	1	1	1	0
---	---	---	---	---	---	---	---

[2]

Page 9	Mark Scheme	Syllabus	Paper
	Cambridge IGCSE – May/June 2015	0478	11

(c) Any **three** from:

- reads values in registers “C” and “D”
- and checks the values against those stored in registers “A” and “B”
(**NOTE:** the first two statements can be interchanged, i.e. “A” and “B” read first)
- If values in corresponding registers are the same
- the microprocessor sends a signal to sound alarm/ring

[3]

(d) Any **three** from:

- uses a light sensor
- sends signal/data back to microprocessor
- signal/data converted to digital (using ADC)
- value compared by microprocessor with pre-set/stored value
- if value < stored value, signal sent by microprocessor ...
- ... to the voltage supply (unit)
- ... “value” of signal determines voltage supplied/brightness of LED

[3]

(e) Any **two** from:

- no need to warm up
- whiter tint/more vivid colours/brighter image
- higher resolution
- much thinner monitors possible/lighter weight
- more reliable technology/longer lasting
- uses much less power/more efficient

[2]

Page 10	Mark Scheme	Syllabus	Paper
	Cambridge IGCSE – May/June 2015	0478	11

9

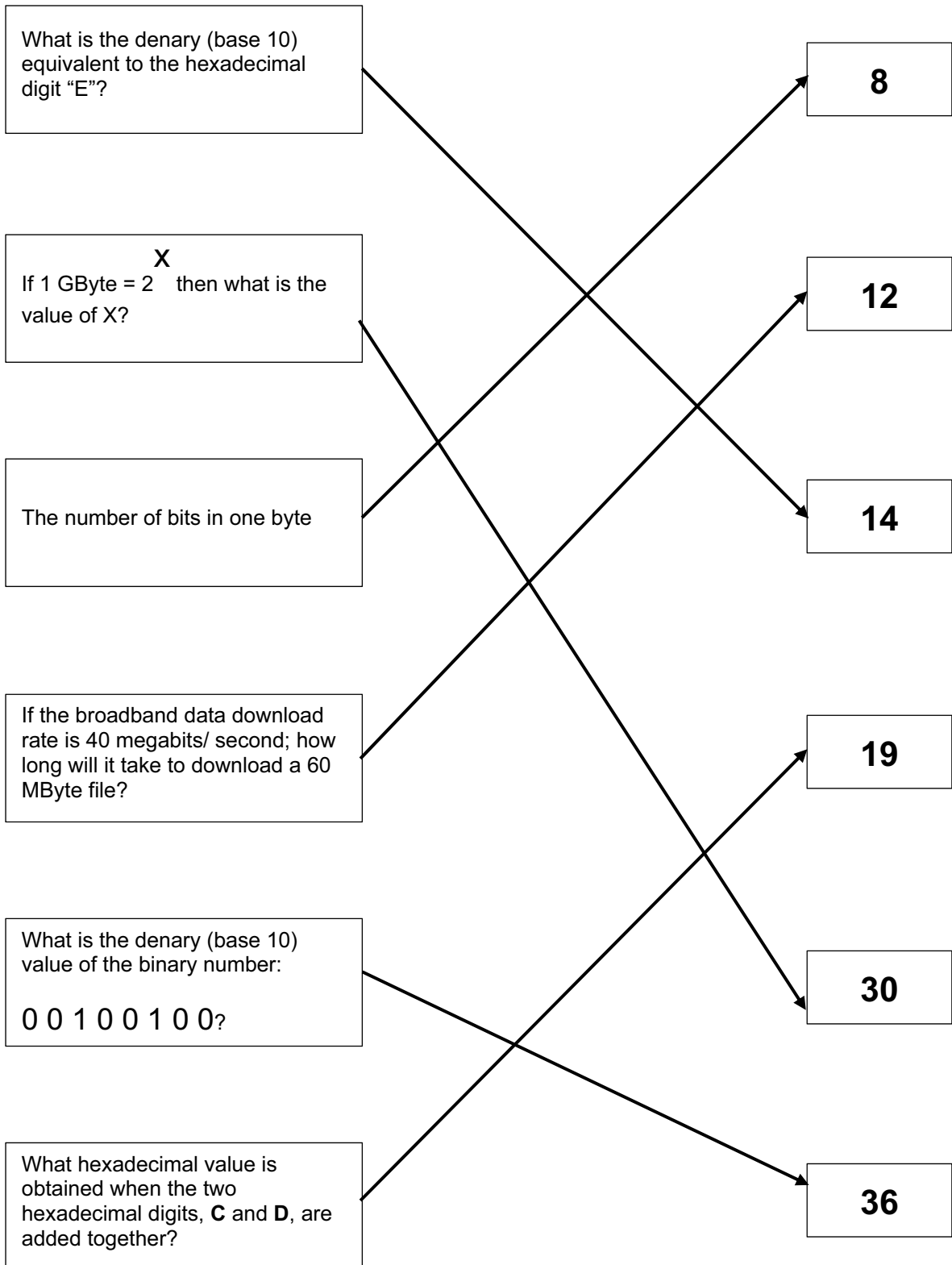

- 5/6 matches – 5 marks
- 4 matches – 4 marks
- 3 matches – 3 marks
- 2 matches – 2 marks
- 1 match – 1 mark

[5]

Page 11	Mark Scheme	Syllabus	Paper
	Cambridge IGCSE – May/June 2015	0478	11

10 1 mark per correctly placed tick

statement	interpreter	compiler
takes one statement at a time and executes it	✓	
generates an error report at the end of translation of the whole program		✓
stops the translation process as soon as the first error is encountered	✓	
slow speed of execution of program loops	✓	
translates the entire program in one go		✓

[5]